

NEWS 2005

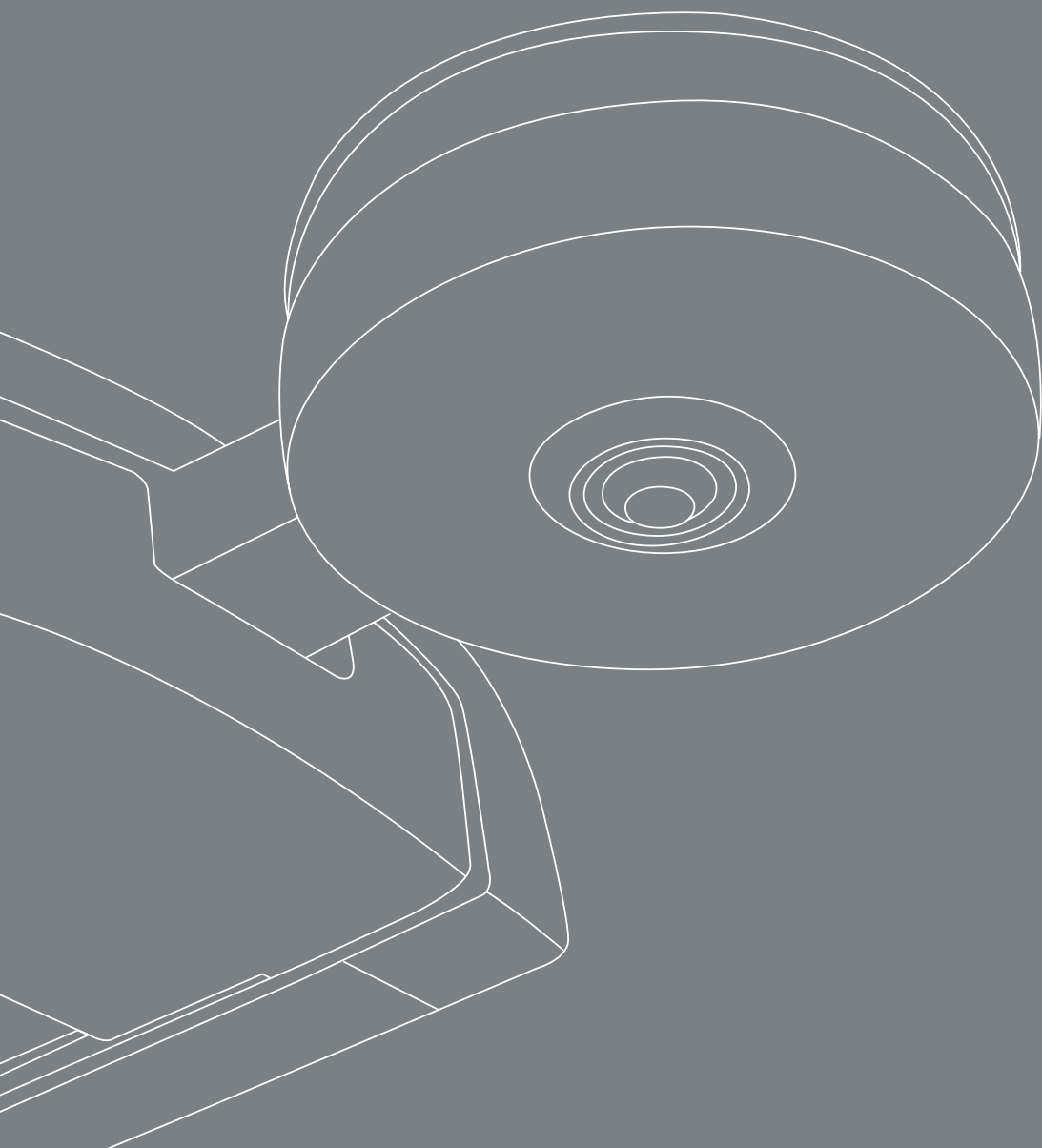

GLAMOX EUROPEAN LIGHTING

for professional solutions

We provide you with solutions

Professional solutions mean more than good design and products which are technically good. They mean being party to a process and contributing practical solutions which simplify the implementation of a project. Our lighting solutions also serve to produce a sense of well-being, improve the output of those working in the light and result in long-term and cost-effective operations. Our solutions are dependent on more than just modern state-of-the-art technology - they require generations of experience.





INDEX

A41-S	page 5
A42-S / A43-S	page 6
A44-S	page 7
ZAPP FROST	page 9
A82-W	page 10
A51-R	page 11
A71-R	page 12
A72-R	page 13
Wall-bracket for C20-P2	page 15
C20 Sensor + System	page 16
C20 Sensor + System	page 17
C20-RL100/175	page 18
C20-S/P1 accessories	page 19
D51-R	page 21
D61-R	page 22
S51-S/P	page 23
D31-R	page 24
D62-R	page 25
O71-R	page 27
O31	page 28
O32	page 29
O72-R / O73-R	page 30



A41-S



- Decorative ceiling or wall luminaire for residential or commercial use
- Diffuser in prismatic opal glass
- Decor ring made of brushed steel

Specifications

Decorative ceiling or wall luminaire with white painted steel body and a decor ring in brushed steel. Diffuser in prismatic opal glass.

Delivered with compensated conventional ballast (F) or electronic ballast (HF).
IP20, class I.

Light source

A41 is available in 2-lamp TC-D/E 18W or 1-lamp TC-DD/E 38W.

Mounting

Surface mounted luminaire for installation on the ceiling or wall.

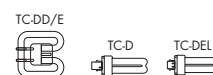
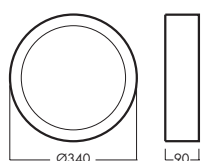

Type	Code no		Weight kg	Lamp ZVEI	Base
	F	HF			
A41-S340 138 BRUSHED STEEL	06564		2.7	TC-DD	GR10q
A41-S340 218 BRUSHED STEEL	06562		2.5	TC-D	G24d-2
A41-S340 218 BRUSHED STEEL		06563	2.0	TC-DEL	G24q-2

A42-S / A43-S



- An elegant wall or ceiling luminaire
- Diffuser in opal glass
- Decor ring made of chrome, brass or white painted steel (A42) and chrome, brass or aluminium (A43)

Specifications

A decorative white painted steel luminaire for residential or commercial use. Can be delivered with decor ring in different finishes. Diffuser in opal glass. A42 is 310mm in diameter and A43 is 400mm. Both can be delivered with compensated conventional ballast (F) or electronic ballast (HF).

IP20, class I

Light source

A42 is available in 2-lamp version TC-D/E 18W, 1-lamp version TC-DD/E 28W or incandescent lamp (max 2x60W). A43 is available in 2-lamp version TC-D/E 26W, 1-lamp version TC-DD/E 28W.

Mounting

Surface mounted luminaire for installation on the ceiling or wall.

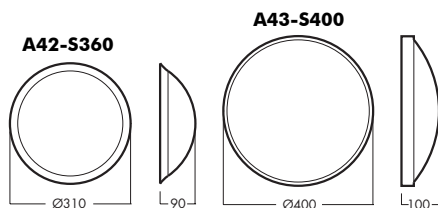

Type	Code no		Weight kg	Lamp ZVEI	Base F	Lamp ZVEI HF	Base HF
	F	HF					
A42-S310 128 BRASS	001643		1.9	TC-DD	GR10q		
A42-S310 128 CHROME	001644		1.9	TC-DD	GR10q		
A42-S310 128 WHITE	001640		1.9	TC-DD	GR10q		
A42-S310 218 BRASS	001649	001650	2.0	TC-D	G24d-2	TC-DEL	G24q-2
A42-S310 218 CHROME	001647	001648	2.0	TC-D	G24d-2	TC-DEL	G24q-2
A42-S310 218 WHITE	001645	001646	2.0	TC-D	G24d-2	TC-DEL	G24q-2
A43-S400 128 ALUMINIUM	001043		3.7	TC-DD	GR10q		
A43-S400 128 BRASS	001040		3.7	TC-DD	GR10q		
A43-S400 128 CHROME	001037		3.7	TC-DD	GR10q		
A43-S400 226 ALUMINIUM	001044	001045	4.2	TC-D	G24d-3	TC-DEL	G24q-3
A43-S400 226 BRASS	001041	001042	4.2	TC-D	G24d-3	TC-DEL	G24q-3
A43-S400 226 CHROME	001038	001039	4.2	TC-D	G24d-3	TC-DEL	G24q-3

A44-S



- Decorative IP54 wall or ceiling luminaire
- Diffuser in opal glass
- Decor ring made of chrome, brushed or white painted steel

Specifications

A circular decorative luminaire for residential or commercial use. White painted steel body with decor ring in chrome, brushed or white painted steel. Diffuser in opal glass. Can be mounted directly on the ceiling or wall. Comes in two different sizes; Ø=30 and 36cm. Delivered with compensated conventional ballast (F) only. IP54, class I.

Light source

A44-S300 (Ø=30cm) is available in 1-lamp TC-DD 16W and A44-S370 (Ø=36cm) in 1-lamp TC-D 26W or TC-DD 28W.

Mounting

Surface mounted luminaire for installation on the ceiling or wall.

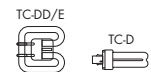
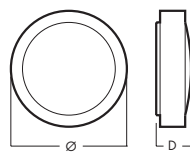

Type	Code no F	D	Ø	Weight kg	Lamp ZVEI	Base
A44-S300 116 BRUSHED STEEL	04515	90	300	2.3	TC-DD	GR8
A44-S300 116 CHROME	04521	90	300	2.3	TC-DD	GR8
A44-S300 116 WHITE	04509	90	300	2.3	TC-DD	GR8
A44-S370 126 BRUSHED STEEL	04519	110	370	3.5	TC-D	G24d-3
A44-S370 126 CHROME	04525	110	370	3.5	TC-D	G24d-3
A44-S370 126 WHITE	04513	110	370	3.5	TC-D	G24d-3
A44-S370 128 BRUSHED STEEL	04518	110	370	3.6	TC-DD	GR8
A44-S370 128 CHROME	04524	110	370	3.6	TC-DD	GR8
A44-S370 128 WHITE	04512	110	370	3.6	TC-DD	GR8



ZAPP FROST

- **Decorative design pendant fitting for direct and indirect lighting**
- **Can be combined with other fittings in the ZAPP family**
- **For use in hallways, receptions and cafe / restaurants**

Specifications

An elegant luminaire in brushed aluminum with a diffuser in opal glass. Available in two sizes $\varnothing=120\text{mm}$ and $\varnothing=200\text{mm}$. The pendant is mounted with three wires and a baldachin in brushed steel at the top. The largest tube is well suited for use in hallways with large ceiling heights, the smallest one can be used in reception areas or similar. Both can be delivered with HF ballast and the largest version can also be delivered for digital dimming (HFDd). IP20, class I.

Light source

1-lamp 18W TC-L or 2-lamp 36W TC-L.

Mounting

Three wires with a 1,5m transparent cable and baldachin.

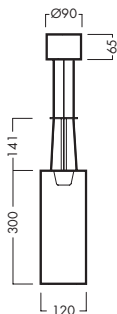

Zapp Frost 120

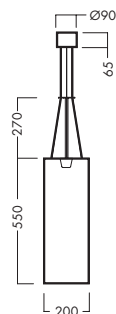

Zapp Frost 200



Type	Code no		Weight kg	Lamp ZVEI	Base
	HF	HFDd			
ZAPP FROST 120 118 GL	243081		0.9	TCL	2G11
ZAPP FROST 120 1X60W GL		243000	0.9	A60	E27
ZAPP FROST 200 236 GL	242982	242986	3.2	TCL	2G11

A82-W



- Wall mounted luminaire in two different sizes
- Diffuser in opal glass
- For residential or commercial use

Specifications

A decorative soft tone luminaire for wall mounting. Grey painted steel body with diffuser in opal glass.

Available in two different sizes (180x300mm and 290x360mm). Delivered with compensated conventional ballast (F) or electronic ballast (HF). IP20, class I.

Light source

A82 is available in 2-lamp version for 18W and 26W TC-D/E or 1-lamp version for 16W and 38W TC-DD/E.

Mounting

Surface mounted luminaire for installation on the wall.

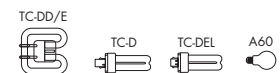
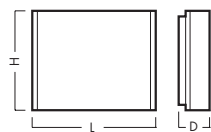

Type	Code no		L	H	D	Weight kg	Lamp ZVEI	Base
	F	HF						
A82-W300 116 ALUMINIUM	06298		300	180	80	2.0	TC-DD	GR8
A82-W300 218 ALUMINIUM	06299		300	180	80	2.3	TC-D	G24d-2
A82-W300 218 ALUMINIUM		06300	300	180	80	1.9	TC-DEL	G24q-2
A82-W300 1X75W ALUMINIUM		06292	300	180	80	1.7	A60	E27
A82-W360 138 ALUMINIUM	06301		360	290	90	1.7	TC-DD	GR10
A82-W360 226 ALUMINIUM	06302		360	290	90	4.1	TC-D	G24d-3
A82-W360 226 ALUMINIUM		06304	360	290	90	3.3	TC-DEL	G24q-3

A51-R

- **Decorative circular luminaire for recessed mounting**
- **Frosted glass diffuser**
- **Decorative secondary light towards the ceiling**

Specifications

A solid luminaire for recessed mounting. Can be delivered in three sizes with diameter 250mm, 400mm and 500mm. The diffuser in frosted glass is held by a white painted metal ring. Between this and the ceiling there is an opalque plastic ring that gives a decorative light towards the ceiling. This luminaire is well suited for canteens, receptions and other meeting areas. A51-R can be delivered for electronic ballast (HF) or dimmable electronic ballast type DSI (HFDd). Can also be delivered with DALI or 1-10V (HFDa) ballast on request. IP20, class I.

Light source

A51-R280 can be delivered with 1x26W, 32W or 42W TC-T lamp, A51-R430 are delivered with T5 circular lamps 1x40W + 1x22W and A51-R530 with 3x36W TC-F lamps.

Mounting

The luminaire is mounted using brackets supplied with the luminaire.

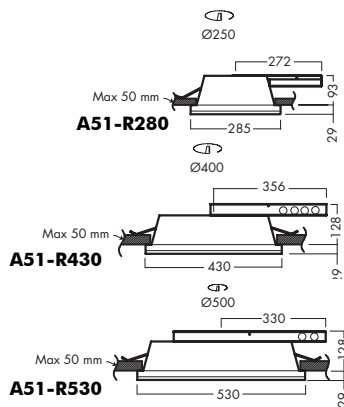

Type	Code no			Weight kg	Lamp ZVEI	Base
	HF	HFDd	HFDa			
A51-R280 126 WHITE	250080	250085	25008502	2.6	TC-TEL	GX24q-3
A51-R280 132 WHITE	250081	250086	25008602	2.6	TC-TEL	GX24q-3
A51-R280 142 WHITE	250082	250087	25008702	2.6	TC-TEL	GX24q-4
A51-R430 122+140 WHITE	250480	250485	25048502	6.2	T-16	2GX13
A51-R530 336 WHITE	250880	250885	25088502	7.2	TC-F	2G10

A71-R



- **Decorative recessed LED luminaire with stainless steel front ring**
- **Low surface temperature on front**
- **12LED or 24LED complete with built in power supply**

Specifications

Decorative light spots for recessed mounting in both floor and wall. Good wear resistance with body in painted die-cast aluminum. Cover ring in stainless steel and diffuser made of opal toughened glass. Stainless steel screws and gaskets made of silicon. Can be delivered in both 12 and 24LED versions with built in power supply. Temperature on the front glass is only 38°C. A ground mounting box made of techno polymer has to be ordered separately. IP67, class I.

Light source

12 or 24LED of max 6W.

Mounting

Luminaire body is mounted in to a sleeve box.

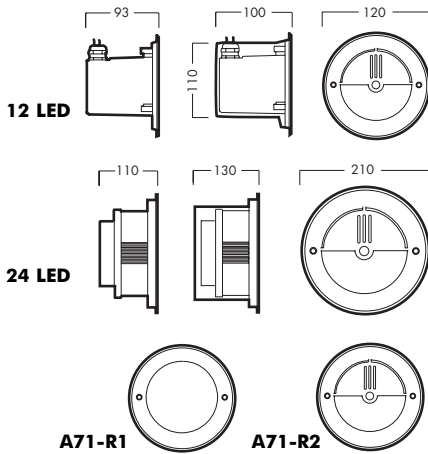
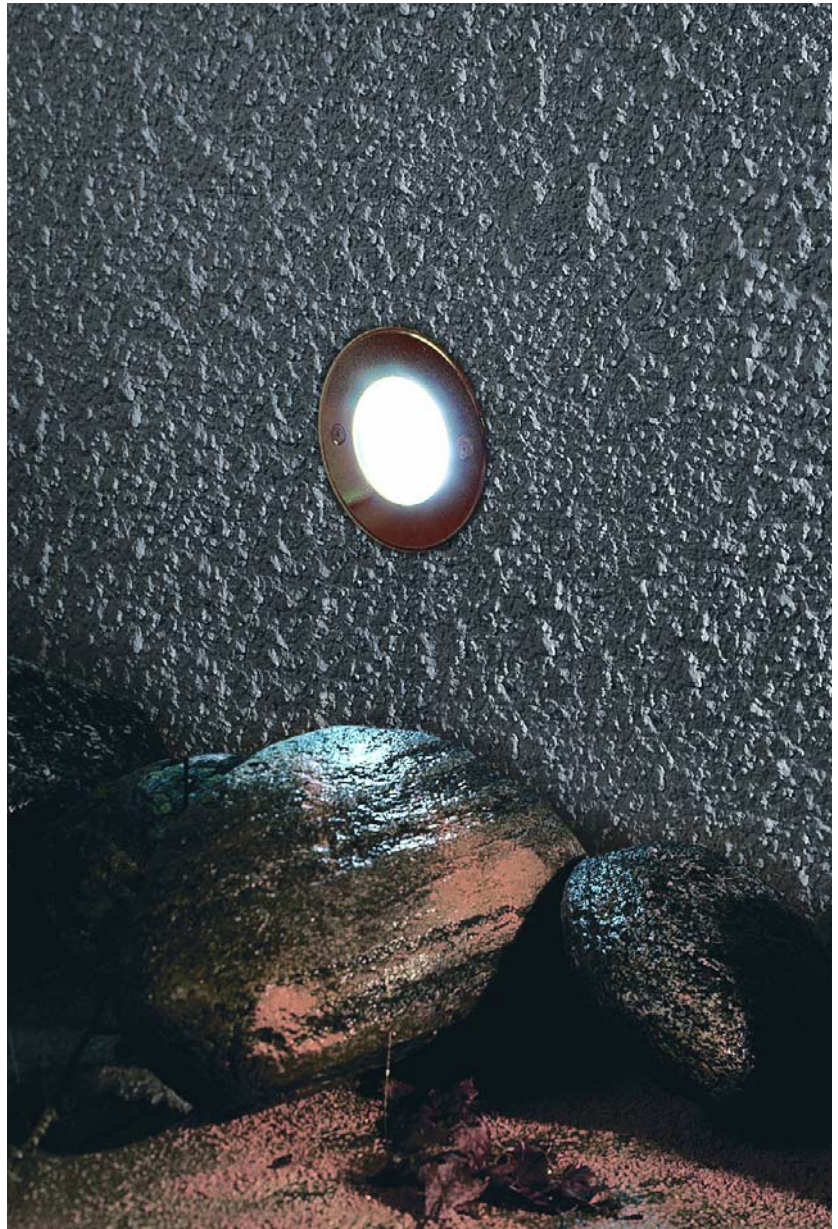

Type	Code no	Weight kg	Lamp
A71-R1 12LED STAINLESS STEEL	525126014	0.9	LED
A71-R1 24LED STAINLESS STEEL	525246019	0.9	LED
A71-R2 12LED STAINLESS STEEL	525126010	0.9	LED
A71-R2 24LED STAINLESS STEEL	525246018	0.9	LED
Accessories			
MOUNTING BOX 12LED	525014010	0.1	
MOUNTING BOX 24LED	525016018	0.1	

A72-R



- **Decorative recessed LED luminaire with stainless steel front ring**
- **Low surface temperature on front**
- **12LED or 24LED complete with built in power supply**

Specifications

Decorative light spots for recessed mounting in both floor and wall. Good wear resistance with body in painted die-cast aluminum. Cover ring in stainless steel and diffuser made of opal toughened glass. Stainless steel screws and gaskets made of silicon. Can be delivered in both 12 and 24LED versions with built in power supply. Temperature on the front glass is only 38°C. A ground mounting box made of techno polymer has to be ordered separately. IP67, class I.

Light source

12 or 24LED of max 6W.

Mounting

Luminaire body is mounted in to a sleeve box.

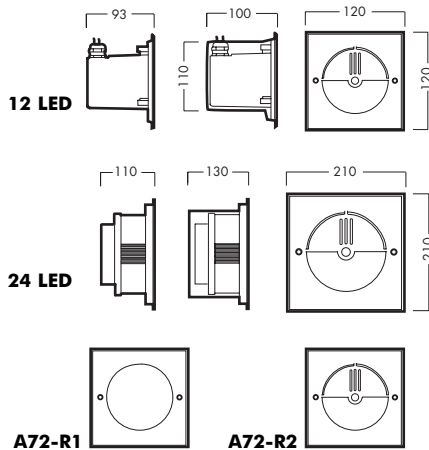
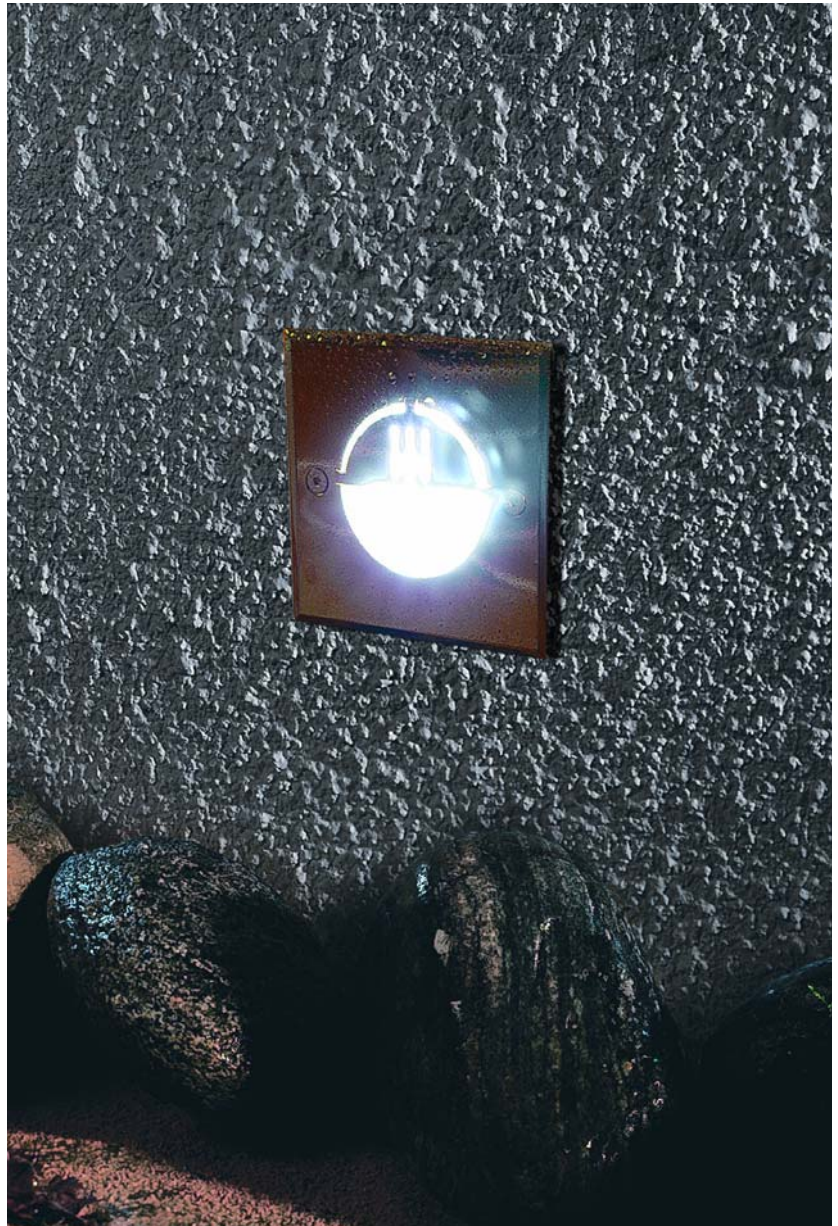

Type	Code no	Weight kg	Lamp
A72-R1 12LED STAINLESS STEEL	525126012	0.9	LED
A72-R1 24LED STAINLESS STEEL	525246015	0.9	LED
A72-R2 12LED STAINLESS STEEL	525126011	0.9	LED
A72-R2 24LED STAINLESS STEEL	525246016	0.9	LED
Accessories			
MOUNTING BOX 12LED	525014010	0.1	
MOUNTING BOX 24LED	525016018	0.1	



Wall-bracket for C20-P2



- An elegant wall-bracket
- End brackets in cast aluminium
- Used together with a standard luminaire type C20-P2



Specifications

MNT C20-P2 / W is an elegant wall bracket that together with the luminaire C20-P2 makes an elegant luminaire for wall mounting. The bracket is easy to mount and contains a fastening plate in grey painted steel with end brackets in cast aluminium. The termination block is mounted on this mounting plate from which there is a transparent cable to the luminaire. The same bracket can be used together with luminaires with standard HF ballast and 1-10V dimmable ballast (HFDa). The luminaire type C20-P2 must be ordered separately.

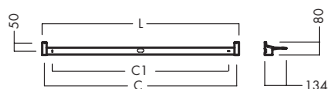

Type	Code no			
		L	C	C1
MNT C20-P2 W600 GREY	815403110	628	600	500
MNT C20-P2 W1200 GREY	815403114	1228	1200	1100
MNT C20-P2 W1500 GREY	815403116	1528	1500	1400

C20 Sensor + System



- Sensor brackets designed for the luminaire
- Flexible system solution
- Solid X, Y and L joints in metal



Sensor

The C20 family can be delivered with 2 alternative sensors. One for ordinary HF ballast that turns the light on/off by movement or sufficient daylight. Both the time delay (for movement detector) and the amount of daylight can be adjusted (daylight sensor can be turned off). The other sensor is for DALI ballast and have a movement detector (on/off), daylight detector (stepless regulation according to daylight contribution) and an IR-detector for remote control to override the other sensors. Both sensors can be delivered with all types of the C20 family using SL, SA, SU, DL, DA or DU optic. In addition we can deliver a special bracket for use together with C20-P2 when using other optics.

System

C20-P2 luminaires can now be used with a system suspension of X, Y, L or I type (see next page). The termination block is mounted on this mounting plate from which there is a transparent cable to the luminaire. You have to specify luminaire types END or MID because these have the correct end brackets and through wiring. All the suspension kits for system solutions contain a suspension wire, 5 leads for connection to the luminaire and a $\pm 90^\circ$ adjustable connection element in painted steel.



C20 Sensor + System



SYSTEM L-SOLUTION

System link grey
System link white

Item no. 815403100
Item no. 815403101

*For linking luminaires in a row with possibilities for swing. Can be angled $\pm 90^\circ$.
The kit contains link, through wiring and a single wire suspension.
When choosing luminaires look at the bottom of this page.*



SYSTEM Y-SOLUTION

System link grey
System link white

Item no. 815403102
Item no. 815403103

*For T or Y connection of luminaires. Can be angled $\pm 90^\circ$.
The kit contains link, through wiring, wire connectors and a single wire suspension.
When choosing luminaires look at the bottom of this page.*

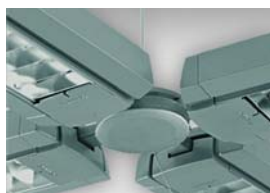

SYSTEM X-SOLUTION

System link grey
System link white

Item no. 815403104
Item no. 815403105

*For X connection of luminaires. Can be angled $\pm 90^\circ$. The kit contains link,
through wiring, wire connectors and a single wire suspension.
When choosing luminaires look at the bottom of this page.*

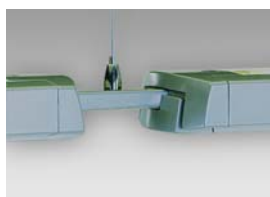

KIT FOR ROW MOUNTING

Grey
White

Item no. 815403106
Item no. 815403107

*For row mounting where swing is not necessary.
The kit contains link, through wiring and a single wire suspension.
When choosing luminaires look at the bottom of this page.*

	C1	C2	C3	C4
14W / 24W	720	840	670	740
21W / 39W	1020	1140	970	1040
28W / 54W	1320	1440	1270	1340
35W / 49W	1620	1740	1570	1640

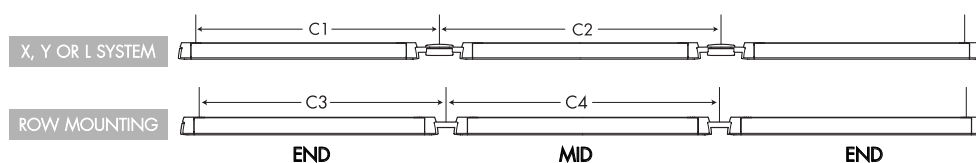

Remember to choose variant marked END or MID. MID is all luminaires placed between two other luminaires.

C20-RL100/175



- Only 100mm wide (R100)
- For continuous mounting
- 2 lamps in one louvre optic

Specifications

Extremely narrow luminaire for recessed mounting. The luminaire can be delivered with 1 or 2 lamps in one louvre optic. Two types of mounting brackets can be used for mounting the luminaire from underneath. One mounted on the end and the other on the side. The luminaire can also be layed directly in a T-profile ceiling without using any brackets.

Mains connection is under the component plate. This luminaire is available with ordinary HF ballast and dimmable digital ballast (HFDd) type DSI. Can also be delivered with dimmable 1-10V ballast (HFDa), DALI ballast and emergency light with battery back up can be delivered on request.

Light source

For T5 light source both HE (High efficiency) and HO (High output) variants. Can be delivered in 14/24, 28/54 and 35/49W lengths.

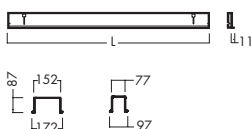

Type	Code no HF	HFDd	L	Lamp ZVEI	Base
C20-RL100 128 SL	C20044674	C20044685	1173	T16	G5
C20-RL100 135 SL	C20044675	C20044686	1473	T16	G5
C20-RL100 149 SL	C20044676	C20044687	1473	T16	G5
C20-RL100 154 SL	C20044677	C20044688	1173	T16	G5
C20-RL100 228 SU	C20044678	C20044689	1173	T16	G5
C20-RL100 235 SU	C20044679	C20044690	1473	T16	G5
C20-RL100 249 SU	C20044680	C20044691	1473	T16	G5
Accessories					
MNT C20-RL (4PCS)			815403024		
MNT END C20-RL100			815403025		
C20-RL100 END CAP			815403027		

Accessories Glamox C20-S and C20-P1



GLAMOX C20-S



GLAMOX C20-P1

KIT FOR ROW MOUNTING

The kit consists of: Cables for through-wiring, light trap and screw/nut.



A	14/24W	14/24W	D	28/54W	35/49W
B	28/54W	28/54W	E	35/49W	14/24W
C	35/49W	35/49W	F	28/54W	14/24W

A: Code no: 815403070

B: Code no: 815403071

C + D: Code no: 815403072

E + F: Code no: 815403073

Not possible to choose any type of cord switch for continuous mounting.



SINGLE WIRE SUSPENSION

1.5 m: Code no: 815403012

4 m: Code no: 815403013

Order one single wire for each joint. In addition order one complete suspension, see "Suspension system for the Glamox C20".

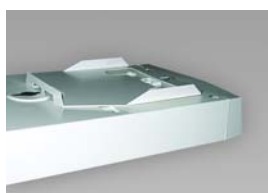

DISTANCE BRACKET FOR CEILING MOUNTING OF C20-S

Gives space for cables between luminaire top and ceiling

Code no: 815403080

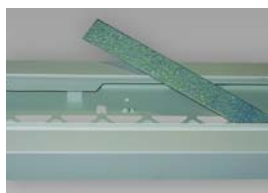

BALANCE-WEIGHT FOR C20-S*)

	1 lamp	2 lamp
HF	Code no: 815403050	Code no: 815403051
HFDa	Code no: 815403053	Code no: 815403055
HFDd / DALI	Code no: 815403052	Code no: 815403054

*) Balance-weight for C20-P1 and C20-P2 is delivered with the luminaires.



DUST COVER FOR C20-P1

150 28/54W	Code no: 815403030
225 28/54W	Code no: 815403032
150 35/49W	Code no: 815403031
225 35/49W	Code no: 815403033

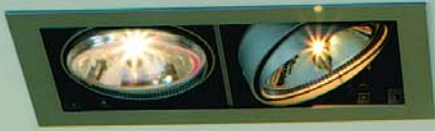

D51-R



- Recessed downlight for different types of light sources
- Easy installation to the ceiling
- Suitable for different types of applications



Specifications

A trendy recessed square or rectangular downlight system for both halospot and metal halide / white Son light sources. Housing in black painted metal and front frame of anodised aluminium.

Lamp holders made in aluminum that can be tilted $\pm 45^\circ$ in two axes. The ballast or transformer must be ordered separately. IP20, class III (QR111) and class I (HIT / HST).

Light source

Can be delivered for metal halide lamp (HIT-TC) 70W, high-pressure sodium (HST-CRI) 100W or halospot lamp (QR111) 75W.

Mounting

Mounting by using adjustable brackets.

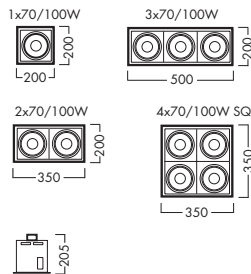

Type	Code no	Code no	Code no	Code no	Weight kg	Lamp ZVEI	Base
D51-R 50W QR111	803128	803228	803328		1.6 / 2.4 / 3.3	QR111	G53
D51-R 70W HIT-TC	805128	805228	805328	805428	1.7 / 2.5 / 3.5 / 4.9	HIT-TC	G8.5
D51-R 100W HST-CRI	806128	806228	806328	806428	1.7 / 2.5 / 3.5 / 4.9	HST-CRI	GX12
	168x168mm	318x168mm	468x168mm	318x318mm			
Accessories							
D51-R TRANSF 105VA QR111	0731-15				0.3		
D51-R TRANSF 200VA QR111	0733-15				0.5		
D51-R BALLAST 1X35F HIT-TC	0565-00				1.7		
D51-R BALLAST 1X70F HIT-TC	0566-00				1.8		
D51-R BALLAST 1X50HF HST-CRI	0557-00				0.3		
D51-R BALLAST 1X100HF HST-CRI	0558-00				0.3		

D61-R



- Recessed downlight for halogen dichroic lamp
- Can be delivered for 1, 2 or 3 lamps
- Modern designed downlight system for residential or commercial use

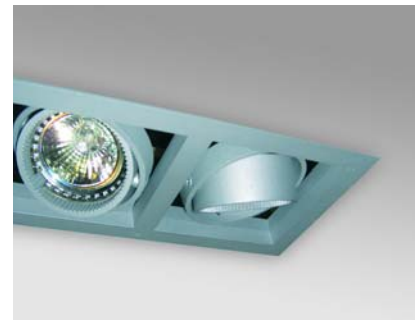

Specifications

A small and elegant downlight system for recessed mounting. Housing made of black painted metal with front frame in anodised aluminum. Lamp holders made in aluminum that can be tilted $\pm 45^\circ$ in two axes. Well suited for both residential and commercial use. IP20, class III.

Light source

Delivered for halogen dichroic lamp (QR-CBC) max. 50W.

Mounting

Spring clips allow tool-free installation. Maximum ceiling thickness = 15mm.

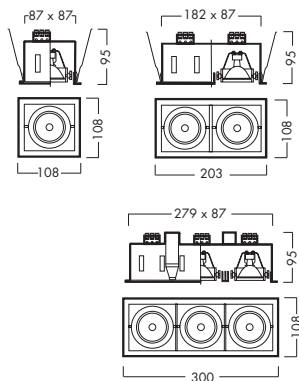

Type	Code no	Weight kg	Lamp ZVEI	Base
D61-R 1X50W	8021-28	0.5	QR-CBC	GX5.3
D61-R 2X50W	8022-28	0.8	QR-CBC	GX5.3
D61-R 3X50W	8023-28	1.2	QR-CBC	GX5.3

S51-S/P

- Pendant or wall mounted spotlight for halospot or halogen dichroic lamps
- Lamp can be orientated on the vertical and horizontal axis
- Can be used in many different applications

Specifications

A modern spotlight system in a square or rectangular frame made of grey painted aluminum. S51-P and S51-W are both delivered complete with standard electronic transformer. A transparent cable is used between the ceiling cup and the fixture. The lamps can be orientated both on the vertical and horizontal axis. Typical applications are shops, reception areas, art museums and cafe / restaurants.

IP20, class II.

Light source

Can be delivered for halospot lamp (QR111) 50W or MR16 lamp 50W.

Mounting

Mounting with use of 4x2M wire.

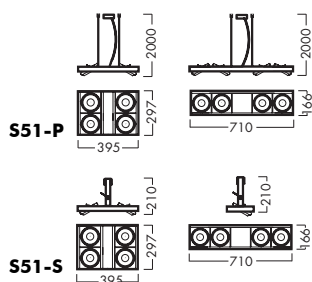

Type	Code no	Weight kg	Lamp ZVEI	Base
S51-S 4X50W RECTANGULAR	742128	4.7	QR-CBC	GX5.3
S51-S 4X50W SQUARE	742028	4.2	QR-CBC	GX5.3
S51-S 4X50W RECTANGULAR	740128	4.7	QR111	G53
S51-S 4X50W SQUARE	740028	4.2	QR111	G53
S51-P 4X50W RECTANGULAR	742728	4.7	QR-CBC	GX5.3
S51-P 4X50W SQUARE	742628	4.2	QR-CBC	GX5.3
S51-P 4X50W RECTANGULAR	740728	4.7	QR111	G53
S51-P 4X50W SQUARE	740628	4.2	QR111	G53

D31-R



- Recessed adjustable downlight for metal halide lamp (HIT)
- Quick connection between the ballast and the downlight
- Easy installation

Specifications

Recessed adjustable downlight for metal halide lamp (HIT) in colour grey ally-look or white painted steel. D31 can be tilted 40° and rotates 355°. Delivered complete with compensated conventional ballast (F) or electronic ballast (HF) on request. IP40, class I.

Light source

D31 is available in metal halide (HIT)
35W - 70W - 150W.

Mounting

Mounting by using adjustable brackets.

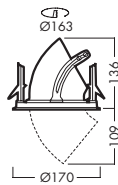

Type	Code no F	Weight kg	Lamp ZVEI	Base
D31-R160 1X35W ALUMINIUM	8801-28	3.4	HIT-CE	G12
D31-R1601X35W WHITE	8801-16	3.4	HIT-CE	G12
D31-R160 1X70W ALUMINIUM	8802-28	3.4	HIT-CE	G12
D31-R160 1X70W WHITE	8802-16	3.4	HIT-CE	G12
D31-R160 1X150W ALUMINIUM	8803-28	3.4	HIT-CE	G12
D31-R160 1X150W WHITE	8803-16	3.4	HIT-CE	G12

D62-R



- A recessed low voltage halogen luminaire with a modern design
- Suited for both residential or commercial use
- Available in various colour finishes

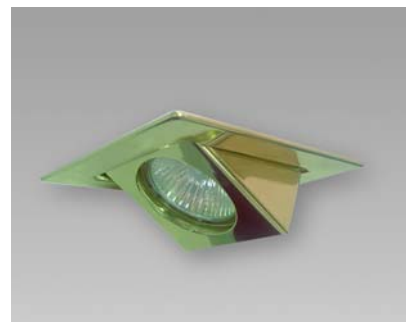
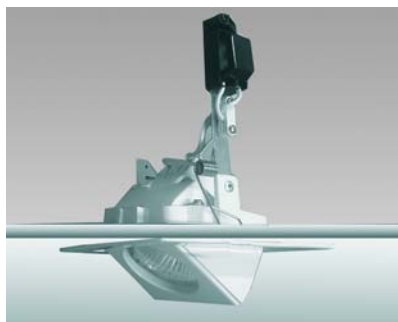

Specifications

12V downlight in cast aluminium in white, brass, chrome or brushed steel. Downlight for halogen reflector lamps. Can be tilted up to 80°. 12V transformer has to be ordered separately.

Light source

MR16 lamps 20W, 35W and 50W with GX/GU5,3 socket. An aluminium reflector is recommended when using a 50W lamp.

Mounting

Spring clips allow tool-free installation.

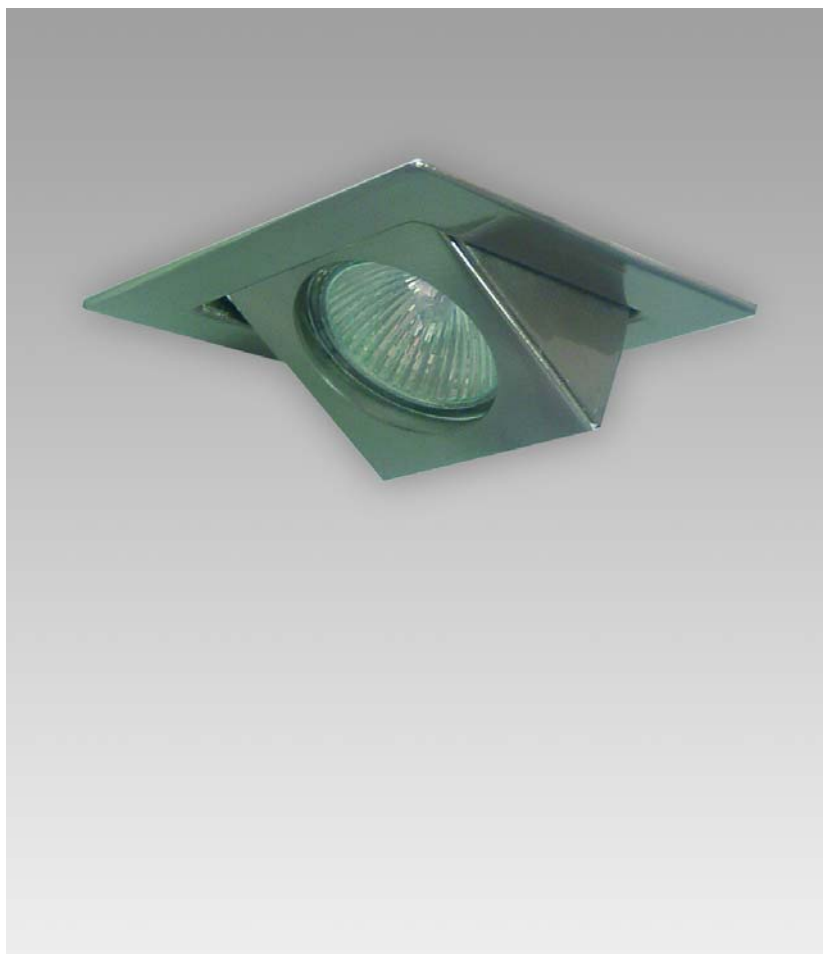

Type	Code no	Weight kg	Lamp ZVEI	Base
D62-R 50W BRASS	575115005	0.3	QR-CBC	GX5.3
D62-R 50W BRUSHED STEEL	575115026	0.3	QR-CBC	GX5.3
D62-R 50W WHITE	575115004	0.3	QR-CBC	GX5.3



O71-R



- LED luminaire for outdoor use
- Different light distributions
- 12LED complete with power supply
- Max load carrying capacity is 1000 kg

Specifications

Recessed 12LED outdoor luminaire for ground and wall mounting with built-in power supply. Body and top-cover in UV-resistant painted die-cast aluminum. The top-cover can be delivered in three different versions, R1, R2 or R3 for flexible light distribution all in colours black or silver. Diffuser made of opal toughened glass. Stainless steel screws and gaskets made of silicon. Maximum load carrying capacity is 1000 kg and the mechanical strength is 12 joule. Temperature on the cover is 25°C. A mounting box made of techno polymer has to be ordered separately. IP67, class I.

Light source

12LED of max 2W.

Mounting

Recessed LED luminaire for installation into a sleeve box that has to be ordered separately.

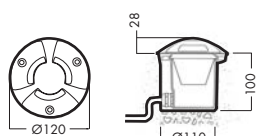

O71-R1



O71-R2



O71-R3

Type	Code no	Weight kg	Lamp
O71-R1 12LED BLACK	525125015	0.7	LED
O71-R1 12LED SILVER	525135015	0.7	LED
O71-R2 12LED BLACK	525125014	0.7	LED
O71-R2 12LED SILVER	525135014	0.7	LED
O71-R3 12LED BLACK	525125016	0.7	LED
O71-R3 12LED SILVER	525135016	0.7	LED
Accessories			
MOUNTING BOX 12LED	525014010	0.1	

O31



- Aluminum housing
- For mercury vapour lamp, compact fluorescent tubes or metal halide lamp
- 3 different heights for different applications

Specifications

Decorative bollard for lighting pathways, entrances, parks and amenity areas. Luminaire housing in aluminum finished with UV resistant polyester powder in colour black or silver. Opal polycarbonate diffuser, silicon gaskets and stainless steel screws. Delivered with compensated conventional ballast (F) only. IP55, class I.

Light source

Mercury vapour lamps (HME) 80W, metal halide lamp (HIT-CE) 35W or compact fluorescent lamp (TC-T) 26W.

Mounting

Mounted directly to fixed base or to a root section that has to be ordered separately.

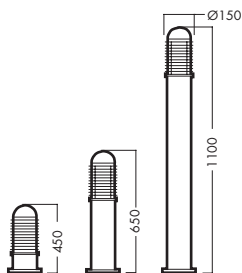

Type	Code no			Weight kg	Lamp ZVEI	Base
	450MM	650MM	1100MM			
O31 126 BLACK	525452003	525452004	525452008	4.1 / 4.9 / 7.0	TC-T	GX24d-3
O31 126 SILVER	525432003	525432004	525432008	4.1 / 4.9 / 7.0	TC-T	GX24d-3
O31 1X35W BLACK	525352003	525352004	525352008	4.1 / 4.9 / 7.0	HIT-CE	G12
O31 1X35W SILVER	525332003	525332004	525332008	4.1 / 4.9 / 7.0	HIT-CE	G12
O31 1X80W BLACK	525552003	525552004	525552008	4.1 / 4.9 / 7.0	HME	E27
O31 1X80W SILVER	525532003	525532004	525532008	4.1 / 4.9 / 7.0	HME	E27
Accessories						
ROOT COLUMN O31/O32	525002007			2.6		

O32



- Aluminum housing
- For compact fluorescent tubes or metal halide lamp
- 3 different heights for different applications

Specifications

Decorative bollard for lighting pathways, entrances, parks and amenity areas. Luminaire housing in aluminum finished with UV resistant polyester powder in colour black or silver. Opal polycarbonate diffuser, silicon gaskets and stainless steel screws. Delivered with compensated conventional ballast (F) only. IP55, class I.

Light source

Metal halide lamp (HIT-CE) 35W or compact fluorescent lamp (TC-T) 26W.

Mounting

Mounted directly to fixed base or to a root section that has to be ordered separately.

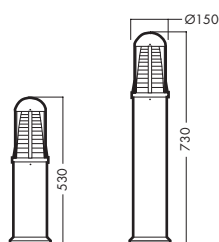

Type	Code no F	Weight kg	Lamp ZVEI	Base
O32 126 530MM BLACK	525452401	4.1	TC-T	GX24d-3
O32 126 530MM SILVER	525432401	4.1	TC-T	GX24d-3
O32 126 730MM BLACK	525452400	4.7	TC-T	GX24d-3
O32 126 730MM SILVER	525432400	4.7	TC-T	GX24d-3
O32 1X35W 530MM BLACK	525352401	4.6	HIT-CE	G12
O32 1X35W 530MM SILVER	525332401	4.6	HIT-CE	G12
O32 1X35W 730MM BLACK	525352400	5.2	HIT-CE	G12
O32 1X35W 730MM SILVER	525332400	5.2	HIT-CE	G12
Accessories				
ROOT COLUMN O31/O32	525002007	2.6		

O72-R / O73-R



- 12LED complete with power supply
- Max load carrying capacity is 2000 kg
- LED luminaire for outdoor use

Specifications

Recessed 12LED outdoor luminaire for ground and wall mounting with built-in power supply. Body in UV-resistant painted die-cast aluminum. Two different versions of cover rings, circular for O72 and square for O73. Both in stainless steel with diffuser made of opal toughened glass. Stainless steel screws and gaskets made of silicon. Maximum load carrying capacity is 2000 kg and the mechanical strength is 12 joule. Temperature on the cover is 25°C. A mounting box made of techno polymer has to be ordered separately. IP67, class I.

Light source

12LED of max 2W.

Mounting

Recessed LED luminaire for installation into a sleeve box that has to be ordered separately.

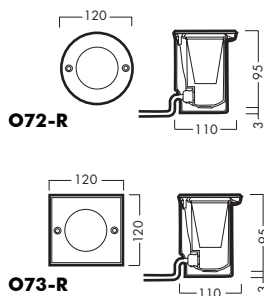

Type	Code no	Weight kg	Lamp
O72-R 12LED STAINLESS STEEL	525125081	0.9	LED
O73-R 12LED STAINLESS STEEL	525125082	0.9	LED
Accessories			
MOUNTING BOX 12 LED	525014010	0.1	



AS Glamox HE

Paldiski mnt 35
76606 Keila
EESTI VABARIIK
Tel.: 6 712 300
Fax: 6 712 305
www.glamox.ee

Glamox Ireland Ltd

Unit D2, Riverview Business Park
Nangor Road
Dublin 12
Tel.: 1 4500 755
Fax: 1 4500 688
www.glamox.com

Glamox Electric (UK) Ltd

5 College Street Mews
Northampton
NN1 2QF
Tel.: 01604 635 611
Fax: 01604 630 131
www.glamox.co.uk

BK999257

