

Frese OPTIMA Compact DN10-DN50 - pressure independent balancing & control valve

Application

Frese OPTIMA Compact pressure independent balancing & control valve (PIBCV) is used in heating and cooling systems in applications with Fan Coil Units, Chilled Beams or other terminal unit applications.

Frese OPTIMA Compact provides modulating control with full authority regardless of any fluctuations in the differential pressure of the system.

Frese OPTIMA Compact combines an externally adjustable automatic balancing valve, a differential pressure control valve and a full authority modulating control valve.

Frese OPTIMA Compact makes it simple to achieve 100% control of the water flow in the building, while creating high comfort and energy savings at the same time. An additional benefit is that no balancing is required if further stages are added to the system, or if the dimensioned capacity is changed.

Energy saving due to optimal control, lower flow and pump pressure. Maximized ΔT due to faster response and increased system stability.

Benefits

Design

- Less time to define the necessary equipment for a hydraulic balanced system (only flow data are required)
- No need to calculate valve authority. Always one.
- Flexibility if the system is modified after the initial installation

Installation

- No further regulating valves required in the distribution pipework when Frese OPTIMA Compact is installed at terminals.
- Total number of valves minimized due to the 3-in-1 design
- Minimized commissioning time due to automatic balancing of the system
- No minimum straight pipe lengths required before or after the valve.

Operation

- High comfort for the end-users due to high precision temperature control
- Longer life due to less movements of the actuator



Features

- The presetting function has no impact on the stroke; Full stroke modulation at all times, regardless the preset flow.
- The constant differential pressure across the modulating control component guarantees 100% authority.
- Automatic balancing eliminates overflows, regardless of fluctuating pressure conditions in the system.
- Thermal actuator On/Off or 0-10V, normally closed.
- Motoric actuator 0-10V, (Linear or Logarithmic) or 3 point control, normally closed.
- Differential pressure operating range up to 800 kPa
- High flows with minimal required differential pressure due to advanced design of the valve
- Small dimensions due to compact housing
- Higher presetting precision due to stepless analogue scale

Frese OPTIMA Compact DN10-DN50 - pressure independent balancing & control valve

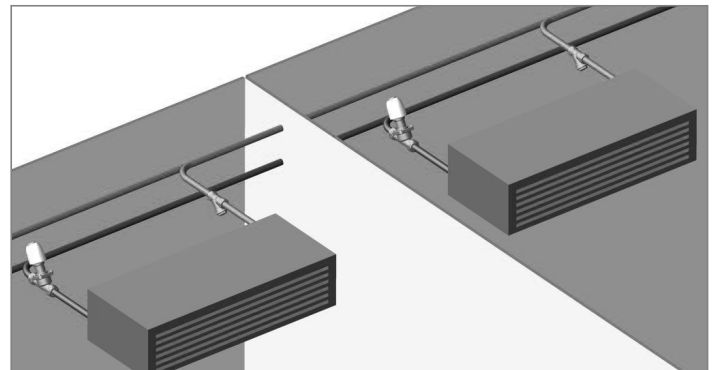
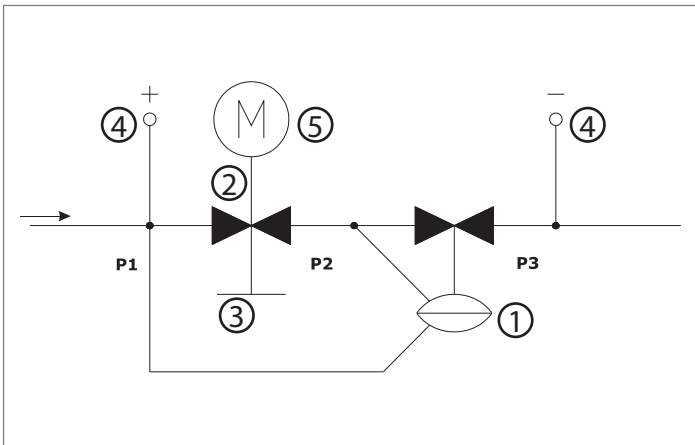

Function

Frese OPTIMA Compact can be flushed and commissioned before the actuator is installed.

The presetting of the dial is user-friendly requiring only a simple flow vs. presetting graph. Once the flow is set, the actuator can be mounted and the valve ready to operate.

For lowest energy consumption, check the differential pressure at the index valve to set the pump at minimum speed.

Operating Pressure

The Frese OPTIMA Compact (DN10 to DN50) can operate to a maximum differential pressure of 800 kPa (8 bar)

Close Off Pressure

The Frese OPTIMA Compact is capable of closing against the following differential pressures to EN 1349 Class IV:

- DN10 to DN25: 600 kPa (6 bar) - based on 100N actuator force
- DN25L to DN32: 800 kPa (8 bar) - based on 100N actuator force
- DN40 to DN50: 800 kPa (8 bar) - based on 400N actuator force

Isolation

When fitted with the isolation cap (DN10 to DN32 only), the Frese OPTIMA Compact is capable of isolation to 10 bar.

Manual operation

Motoric actuators

The actuator can be operated manually with the help of a 3mm hex key.

Note

If the operation is performed manually without disconnecting from the power, the supply must be disconnected and then reconnected, whereby the actuator will start the calibration process and correctly adjust itself.

Design

The design of Frese OPTIMA Compact combines high performance with small size and compact construction. The main components of the valve are:

- ① Differential pressure control
- ② Modulating control component
- ③ Presetting scale (not accessible when the actuator is mounted)
 - a) Flow range: Low-High
 - b) Stroke: 2,5 - 5,0 - 5,5mm
- ④ P/T Plugs (Optional)
- ⑤ Actuator

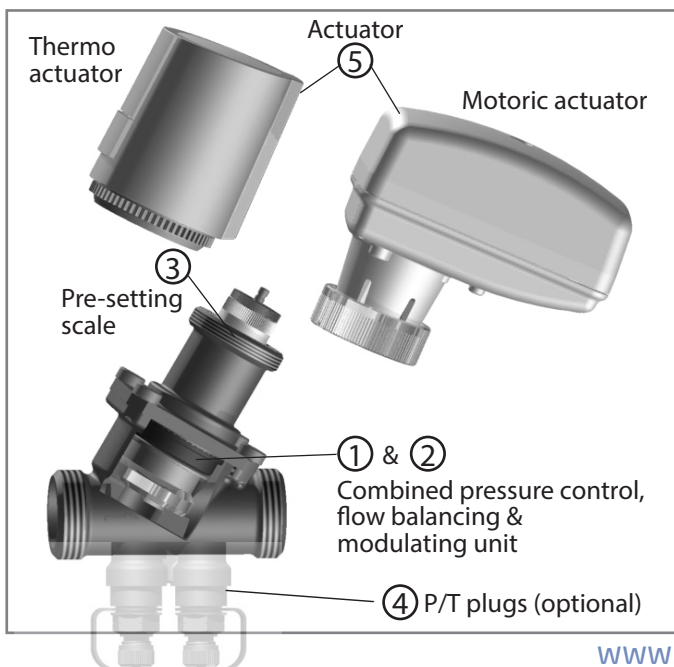
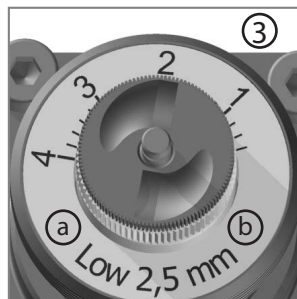

Frese OPTIMA Compact DN10-DN50 - pressure independent balancing & control valve

Operation principle

The innovative design of Frese OPTIMA Compact features a modulating control component that retains 100% authority at all times.

With the Frese OPTIMA Compact, there are two independent movements for the presetting and the modulating function. During presetting, the inlet area moves radially without interfering with the length of the stroke. During modulating, the inlet area moves axial taking advantage of the full stroke.

Whilst the control component provides proportional modulation irrespective of the preset flow, the automatic balancing guarantees that the flow will never exceed the maximum preset flow.

Regardless of pressure fluctuations in the system, the maximum flow is kept constant up to a maximum differential pressure of 800 kPa.

Flow rate vs. Differential Pressure

(Preset flow: 300 l/h, 150 l/h)

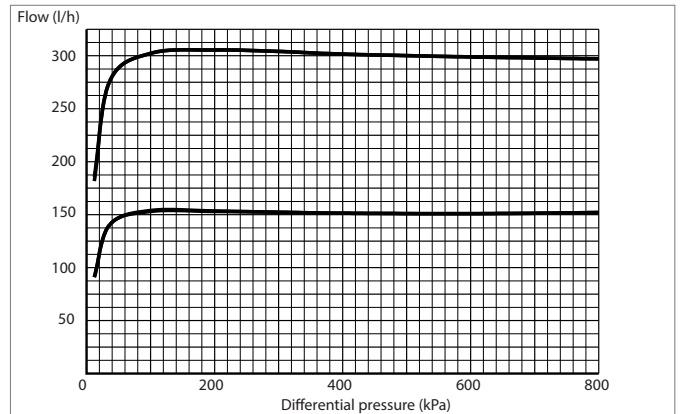

Flow rate vs. Voltage

(Preset flow: 300 l/h, 150 l/h)

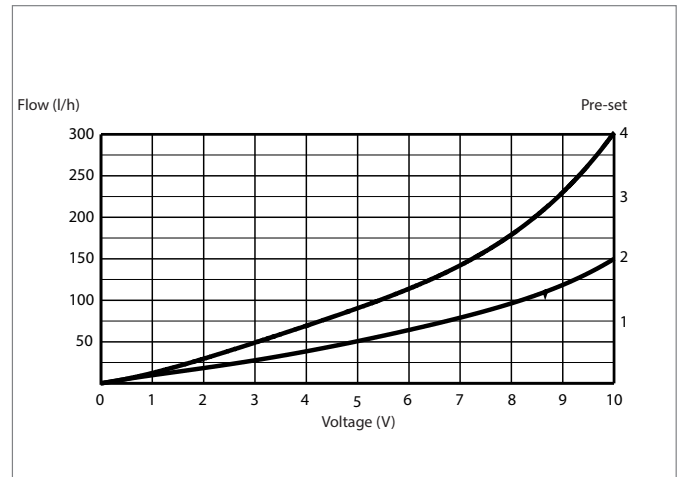

Flow rate vs. Differential Pressure

(Voltage: 10V, 8V, 5V)

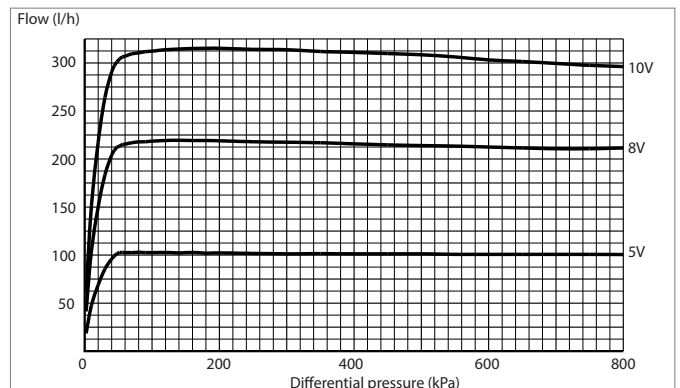

Frese OPTIMA Compact DN10-DN50 - pressure independent balancing & control valve

Technical data

Valve housing:	DZR Brass
DN10-15-20-25-32	Ductile Iron
DN40-50	PPS 40% glass
DP controller:	Stainless steel
Spring:	HNBR
Diaphragm:	EPDM
O-rings:	PN25
Pressure class:	800 kPa
Max. differential pressure:	0°C to 120°C
Medium temperature range:	ISO 228
Thread	

The pipe system shall be properly ventilated to avoid risk of air pockets. Glycolic mixtures up to 50% are applicable (both ethylene and propylene).

Recommendation: Water treatment to VDI 2035.

Frese A/S can accept no responsibility if another actuator is used instead of the Frese actuator.

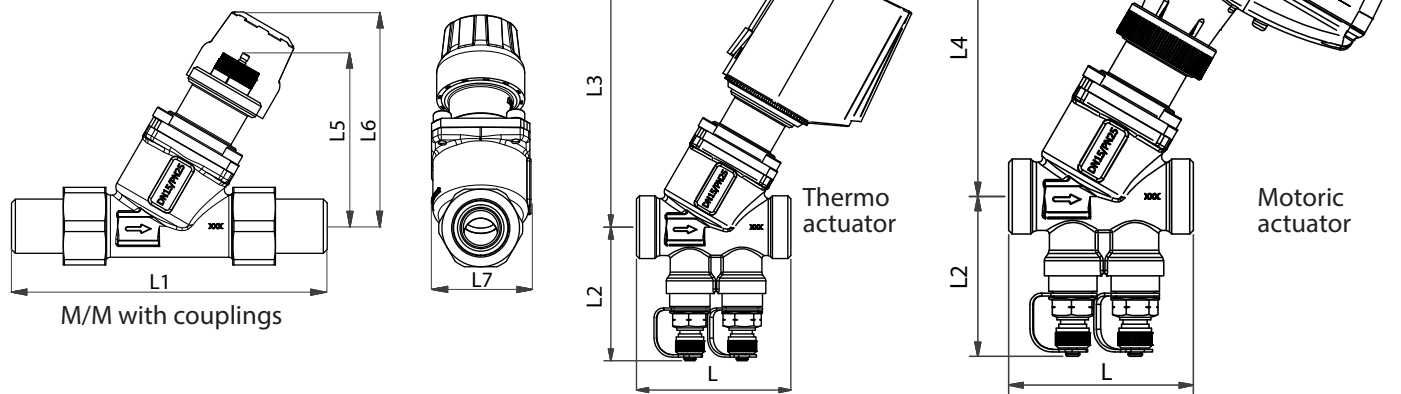

Dimension & Weight

Dim.	DN10	DN15		DN20		DN25/DN25L		DN32		DN40	DN50	
Thread	M/M G 1/2	M/M G 3/4	F/F G 1/2	M/M G 1	F/F G 3/4	M/M G 1-1/4	F/F G 1	M/M G 1-1/2	F/F G 1-1/4	F/F G 1-1/2	F/F G 2	
Length	L	65	65	75	70	79	78/104	83/100	104	104	138	138
	L1	114	122	-	131	-	-	-	-	-	-	-
	L2	57	57	57	57	57	59/63	59/63	68	68	71	77
	L3	121	121	121	121	121	124/139	124/139	139	139	-	-
	L4	117	117	117	117	117	120/135	120/135	135	135	304	304
	L5	68	68	68	68	68	68/85	68/85	85	85	161	161
	L6	83	83	83	83	83	83/100	83/100	100	100	-	-
Weight kg	L7	38	38	38	38	38	38/63	38/63	63	63	90	90
	Basic	0.36	0.38	0.42	0.40	0.45	0.51/1.02	0.55/1.04	1.17	1.17	-	-
	P/T	0.45	0.47	0.52	0.50	0.54	0.62/1.12	0.65/1.14	1.27	1.27	3.28	3.71

Flow

Dim.	DN10 - DN15		DN15 - DN20		DN20	DN25	DN25L	DN32	DN40	DN50	
Type	Low		High		High	Low	High	-	-	-	
Stroke	mm	2.5	5.0	2.5	5.0	5.5	5.5	5.5	15	15	
Flow	l/h	30 - 200	65 - 370	100 - 575	220 - 1330	300-1800	280-1800	600-3609	550-4001	1370-9500	1400-11500
	l/s	0.008-0.056	0.018-0.103	0.028-0.160	0.061-0.369	0.083-0.500	0.078-0.500	0.167-1.003	0.153-1.111	0.381-2.639	0.389-3.194
	gpm	0.13 - 0.88	0.29 - 1.63	0.44 - 2.53	0.97 - 5.85	1.32-7.93	1.23-7.93	2.64-15.89	2.42-17.62	6.03-41.83	6.16-50.63

Frese OPTIMA Compact DN10-DN50 - pressure independent balancing & control valve

Technical data actuators DN 10-15-20-25-32

Characteristics:	Thermo actuators, normally closed
Protection class:	IP 54 to EN 60529
Frequency:	50/60 Hz
Control signal:	0-10V AC-DC or On/Off
Actuating force:	100 N
Stroke:	2.5 - 5.0 - 5.5 mm
Running time:	120 s 0-10V/180 s On/Off
Ambient operating conditions:	0°C to 60°C
Cable length:	1.0 m
Weight:	100 g

On/Off actuator 2.5 mm stroke, 24V AC-DC/ On/Off 180s	48-5525
On/Off actuator 2.5 mm stroke 230V AC/ On/Off 180s	48-5526
On/Off actuator 5.0-5.5 mm stroke, 24V AC-DC/ On/Off 180s	48-5527
On/Off actuator 5.0-5.5 mm stroke 230V AC/ On/Off 180s	48-5528
Modulating actuator 2.5-5.0-5.5 mm stroke 24V AC/0-10V DC 30 s/min	48-5529

Characteristics:	Electrical, modulating
Protection class:	IP 43 to EN 60529
Frequency:	50/60 Hz
Control signal:	0-10V DC or 3 position
Actuating force:	120 N
Stroke max:	5.5 mm (Dip switch setting 2.5-5.0-5.5mm)
Running time 5.5 mm:	75 s 0-10V / 150 s 3-pos
Ambient operating conditions:	+1°C to 50°C
Cable length:	1.5 m
Weight:	215 g

Modulating actuator 5.0 - 5.5 mm, 24V AC-DC/ 0-10V DC/ 8 s/mm	53-1180
Modulating actuator 2.5 - 5.0 - 5.5 mm, 24 V AC/ 3 pos / 13 s/mm	53-1181
Modulating actuator 2.5 - 5.0 - 5.5 mm, 230 V AC/ 3 pos. / 13 s/mm	53-1182
Modulating actuator 2.5 mm, 24V AC-DC/ 0-10V DC/ 8 s/mm	53-1183

Technical data actuator DN 40-50 - actuator included with the valve

Characteristics:	Electrical, modulating, normally closed
Protection class:	IP 54 to EN 60529
Frequency:	50/60 Hz
Supply voltage:	24V AC
Control signal:	0-10V DC or 3 position
Actuating force:	400 N
Stroke max:	32 mm, selfcalibrating
Running time:	60 s
Ambient operating conditions:	-10°C to 50°C
Manual operation:	Manual handle
Cable:	Not included
Weight:	1.80 kg



Frese OPTIMA Compact DN10-DN50 - pressure independent balancing & control valve

Actuator requirements DN 10-15-20-25-32

Dimension "X" in closed position

2.5 mm stroke = 11.4 mm

5.0 mm stroke = 9.3 mm

5.5 mm stroke = 8.8 mm

Actuator minimum force: 100N

Actuator connection: M30 x 1,5mm

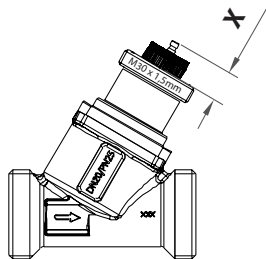

Combination matrix: Frese OPTIMA Compact DN10-15-20-25-32 / Actuators

Frese OPTIMA Compact can be combined with both Thermo actuators and Motoric actuators.

The design of the valve, combined with the Frese actuator, produces a perfect control characteristic that utilises the full control range of the system.

					Thermo Actuators				Motoric Actuators				
					On/Off		0.....10V		0.....10V		3-pos		
Male/Male ISO 228	Type	Stroke	Flow l/h	Dim	24 V 2,5mm	230V 2,5mm	24V 5,0 - 5,5mm	230V 5,0 - 5,5mm	24V 2,5 - 5,0 - 5,5mm	24V 2,5 mm	24V 5,0 - 5,5mm	24V	230V
	DN10 M/M LOW 2.5	2.5	30-200	DN10	●	●			●	●		●	●
	DN10 M/M LOW 5.0	5.0	65-370	DN10			●	●	●		●	●	●
	DN15 M/M LOW 2.5	2.5	30-200	DN15	●	●			●	●		●	●
	DN15 M/M LOW 5.0	5.0	65-370	DN15			●	●	●		●	●	●
	DN15 M/M HIGH 2.5	2.5	100-575	DN15	●	●			●	●		●	●
	DN15 M/M HIGH 5.0	5.0	220-1330	DN15			●	●	●		●	●	●
	DN20 M/M HIGH 2.5	2.5	100-575	DN20	●	●			●	●		●	●
	DN20 M/M HIGH 5.0	5.0	220-1330	DN20			●	●	●		●	●	●
	DN20 M/M HIGH 5.5	5.5	300-1800	DN20			●	●	●		●	●	●
	DN25 M/M LOW 5.5	5.5	280-1800	DN25			●	●	●		●	●	●
	DN25L M/M HIGH 5.5	5.5	600-3609	DN25			●	●	●		●	●	●
DN32 M/M 5.5	5.5	550-4001	DN32			●	●	●		●	●	●	
Female/Female ISO 228	Type	Stroke	Flow l/h	Dim									
	DN15 F/F LOW 2.5	2.5	30-200	DN15	●	●			●	●		●	●
	DN15 F/F LOW 5.0	5.0	65-370	DN15			●	●	●		●	●	●
	DN15 F/F HIGH 2.5	2.5	100-575	DN15	●	●			●	●		●	●
	DN15 F/F HIGH 5.0	5.0	220-1330	DN15			●	●	●		●	●	●
	DN20 F/F HIGH 2.5	2.5	100-575	DN20	●	●			●	●		●	●
	DN20 F/F HIGH 5.0	5.0	220-1330	DN20			●	●	●		●	●	●
	DN20 F/F HIGH 5.5	5.5	300-1800	DN20			●	●	●		●	●	●
	DN25 F/F LOW 5.5	5.5	280-1800	DN25			●	●	●		●	●	●
	DN25L F/F HIGH 5.5	5.5	600-3609	DN25			●	●	●		●	●	●
	DN32 F/F 5.5	5.5	550-4001	DN32			●	●	●		●	●	●

Frese OPTIMA Compact DN10-DN50 - pressure independent balancing & control valve

Types and operation data actuator DN40-DN50

Type	Valve Dimension	Function	Supply voltage	Power Consumption
Type-01	DN40-DN50	0-10 V / 3-pos	24 V AC +25%/- 35%	6 VA

Product programme

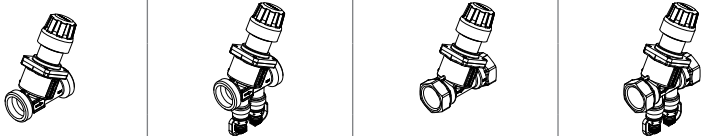
Dim.	Type	Flow l/h				
			M/M	M/M PT plugs	F/F	F/F PT plugs
DN10	Low 2.5 mm	30-200	53-1300	53-1320	-	-
	Low 5.0 mm	65-370	53-1309	53-1329	-	-
DN15	Low 2.5 mm	30-200	53-1302	53-1322	53-1342	53-1362
	Low 5.0 mm	65-370	53-1310	53-1330	53-1350	53-1370
	High 2.5 mm	100-575	53-1304	53-1324	53-1344	53-1364
	High 5.0 mm	220-1330	53-1305	53-1325	53-1345	53-1365
DN20	High 2.5 mm	100-575	53-1312	53-1332	53-1352	53-1372
	High 5.0 mm	220-1330	53-1308	53-1328	53-1348	53-1368
	High 5.5 mm	300-1800	53-1311	53-1331	53-1318	53-1338
DN25	Low 5.5 mm	280-1800	53-1317	53-1337	53-1319	53-1339
DN25L	High 5.5 mm	600-3609	53-1313	53-1333	53-1353	53-1373
DN32	5.5 mm	550-4001	53-1314	53-1334	53-1354	53-1374
DN40	15 mm	1370-9500	-	-	-	53-1375-01
DN50	15 mm	1400-11500	-	-	-	53-1376-01

Accessories

Couplings 2 pcs, incl gasket

Material: DZR Brass, CW602N

Dim.		
	Thread	Item no.
DN10	G 1/2 - R3/8	43-1330
DN15	G 3/4 - R1/2	43-2330
DN20	G 1 - R3/4	43-3330

Insulation - for heating applications only

Material: EPP, Max temperature 120°C

Dim.		
	Item no.	Item no.
DN10-15-20	38-0857	38-0857
DN25	38-0858	38-0858
DN25L-32	38-0859	38-0859

Frese OPTIMA Compact DN10-DN50 - pressure independent balancing & control valve

Frese OPTIMA Compact · Low 2.5 DN10/15

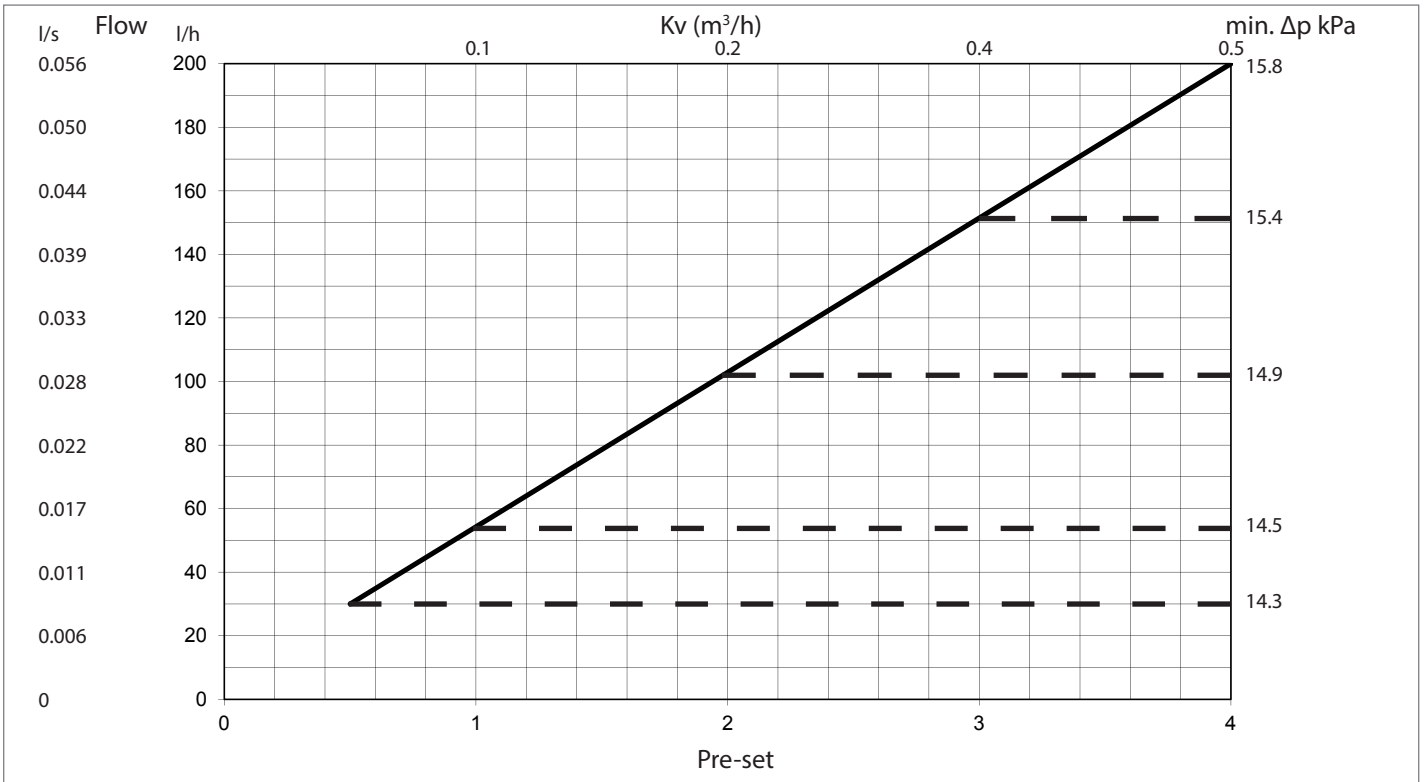

Frese OPTIMA Compact · Low 5.0 DN10/15

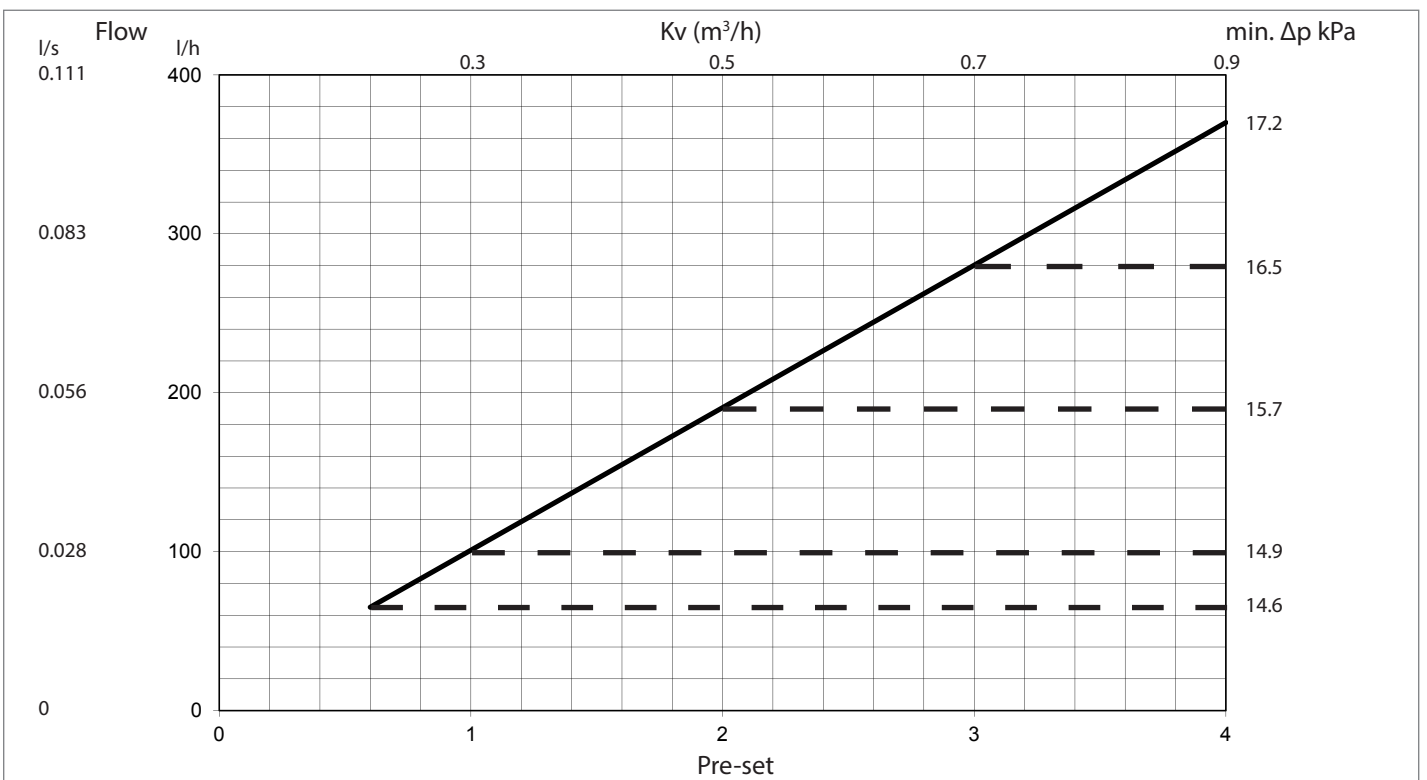

Frese OPTIMA Compact DN10-DN50 - pressure independent balancing & control valve

Frese OPTIMA Compact · High 2.5 DN15/20

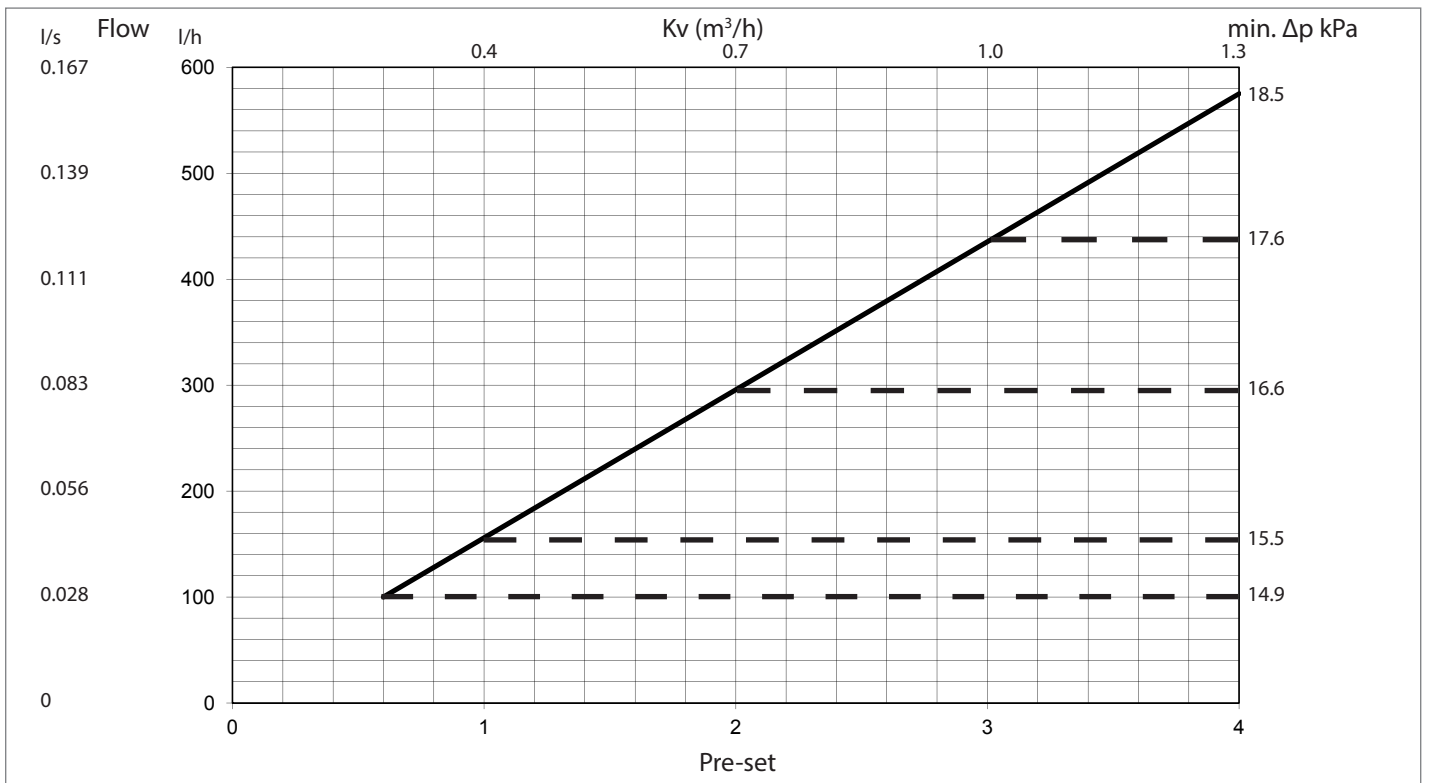

Frese OPTIMA Compact · High 5.0 DN15/20

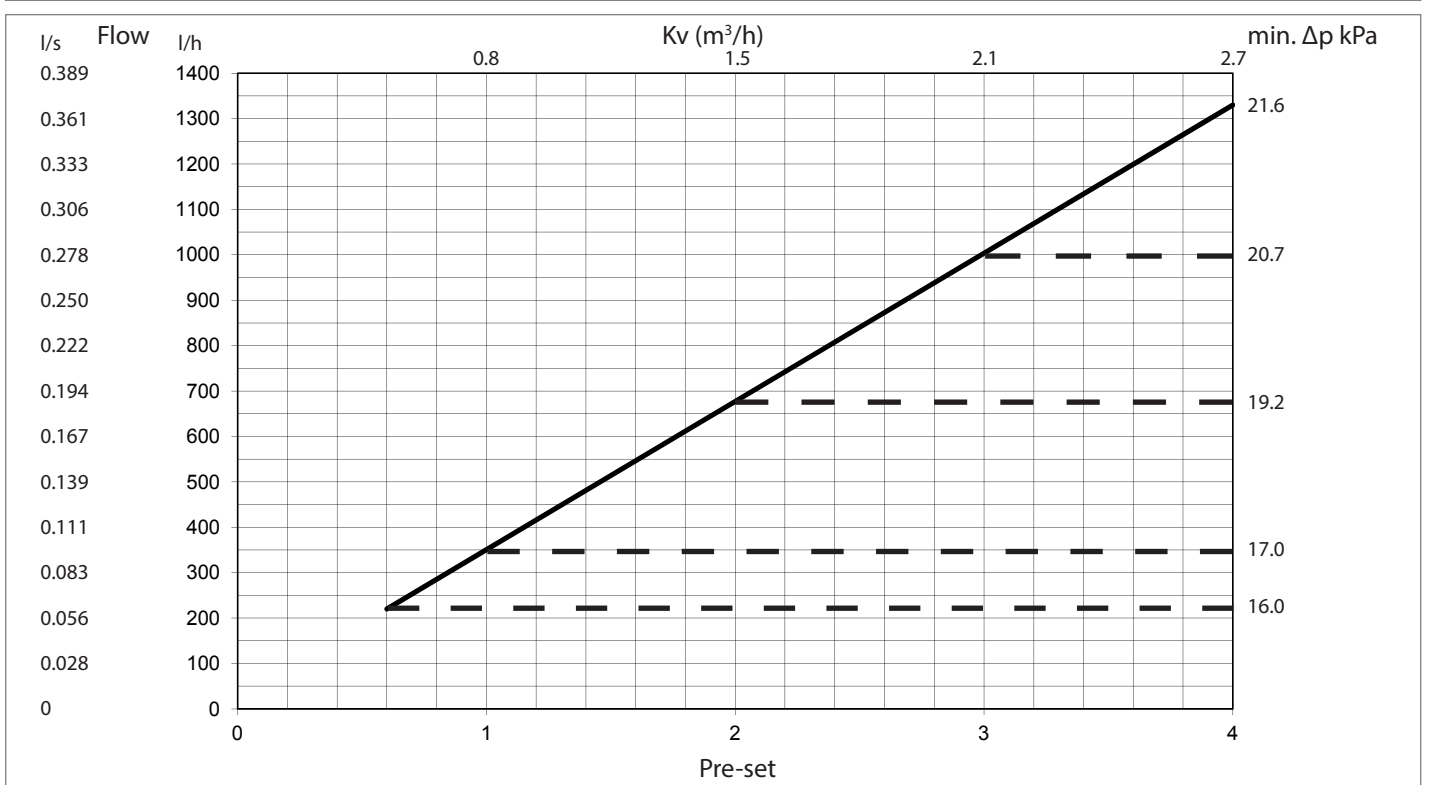

Frese OPTIMA Compact DN10-DN50 - pressure independent balancing & control valve

Frese OPTIMA Compact · High 5.5 DN20

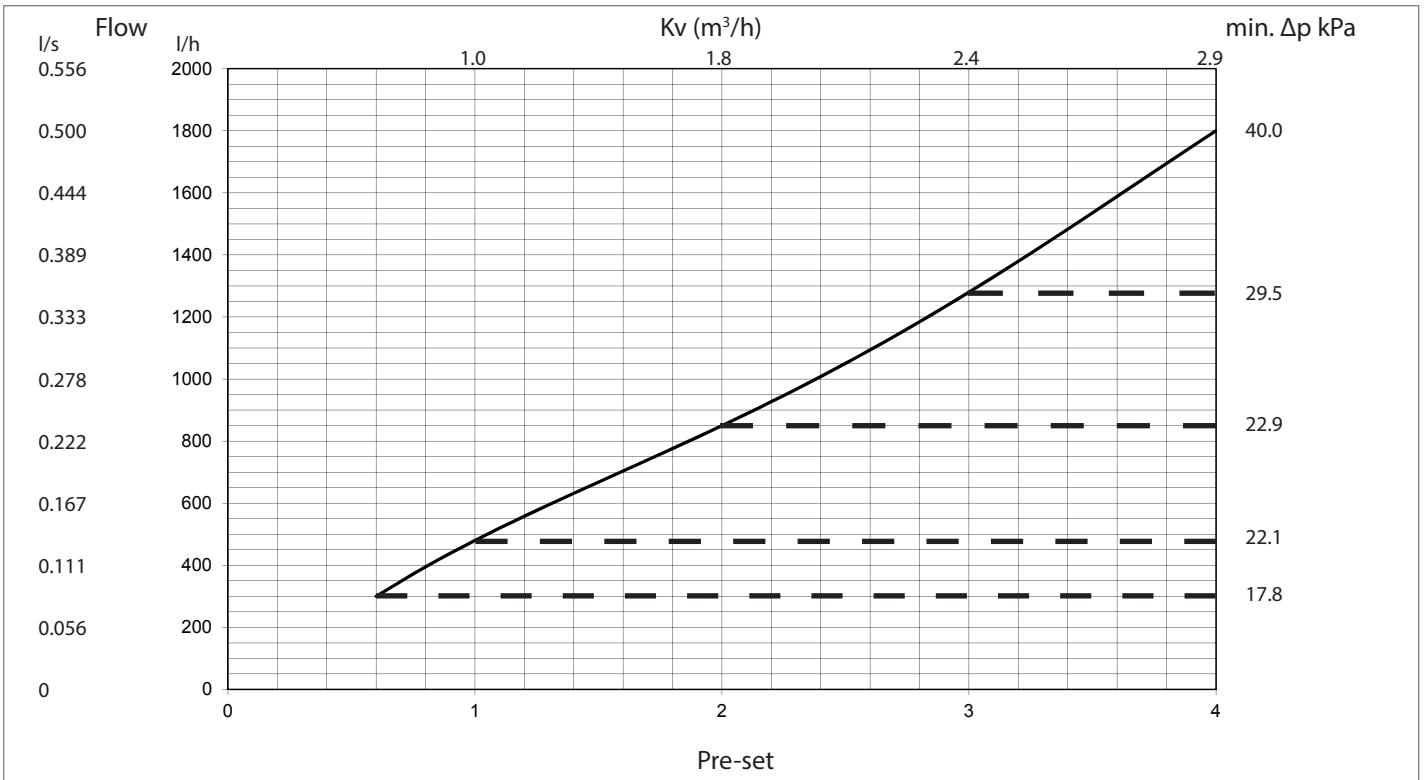

Frese OPTIMA Compact · Low 5.5 DN25

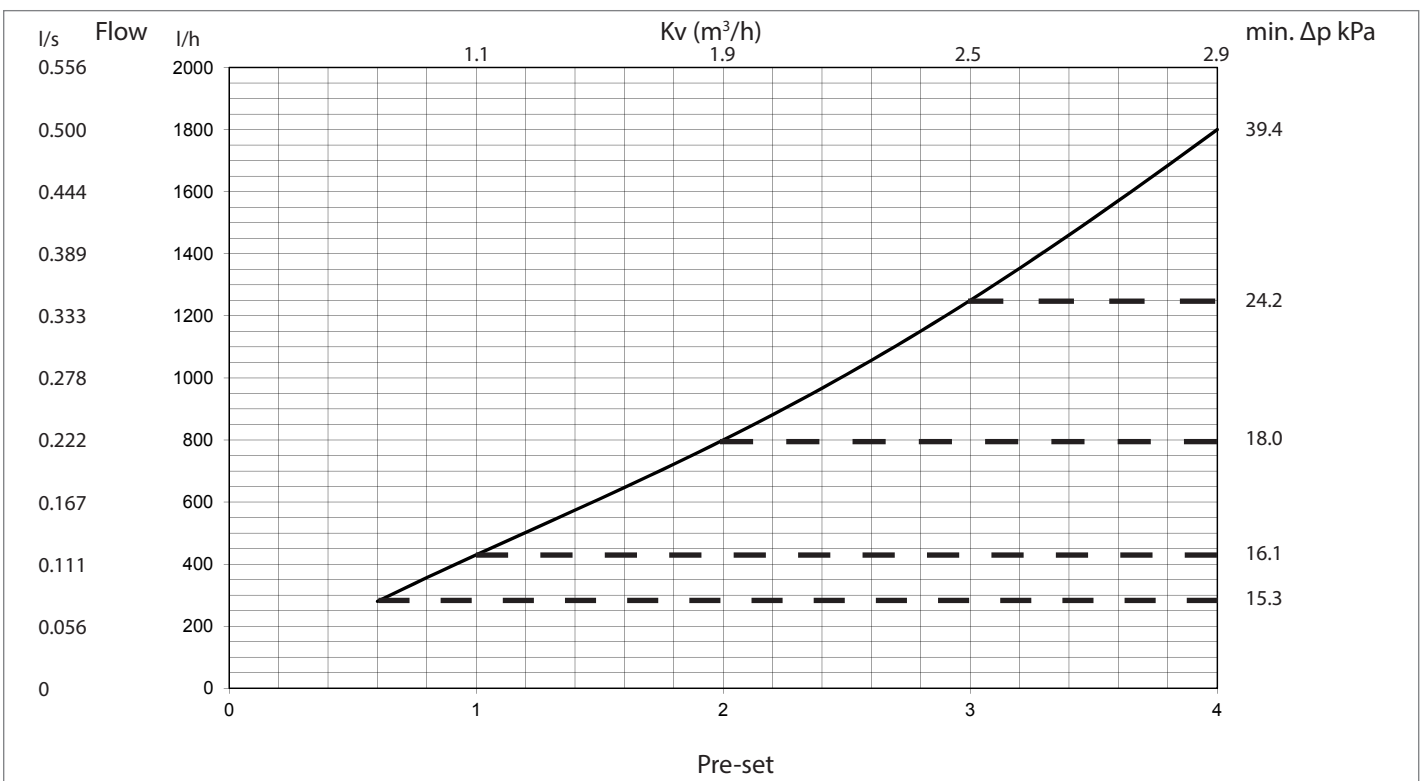

Frese OPTIMA Compact DN10-DN50 - pressure independent balancing & control valve

Frese OPTIMA Compact · High 5.5 DN25L

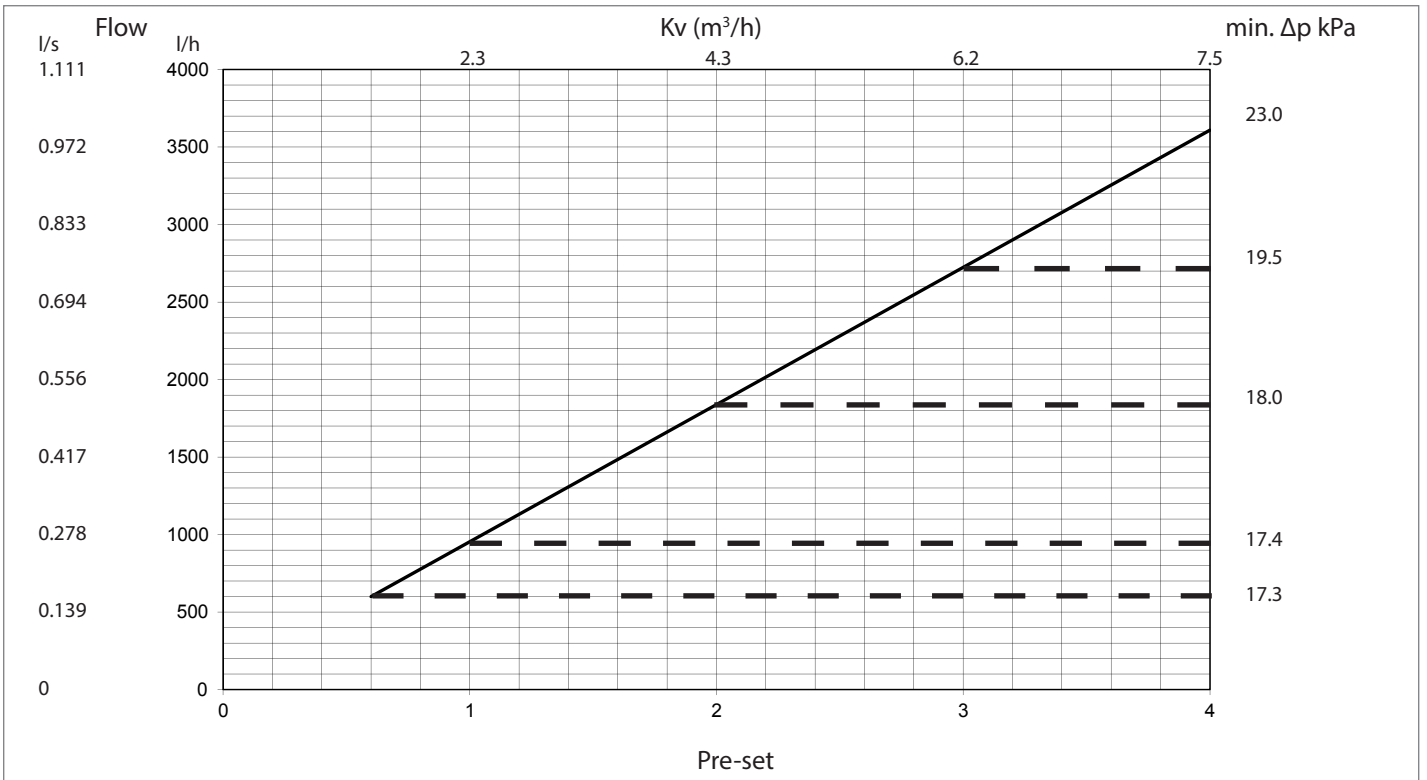

Frese OPTIMA Compact · DN32

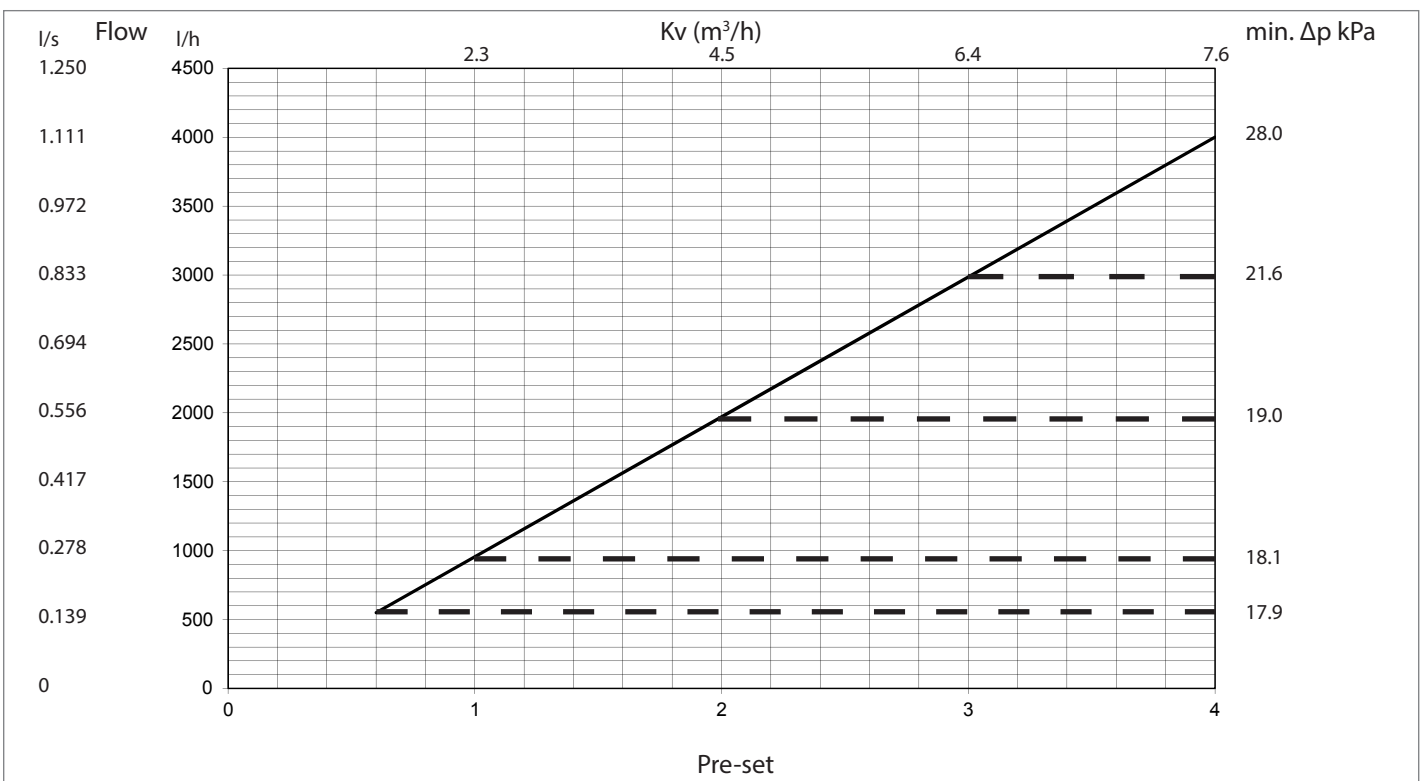

Frese OPTIMA Compact DN10-DN50 - pressure independent balancing & control valve

Frese OPTIMA Compact · DN40

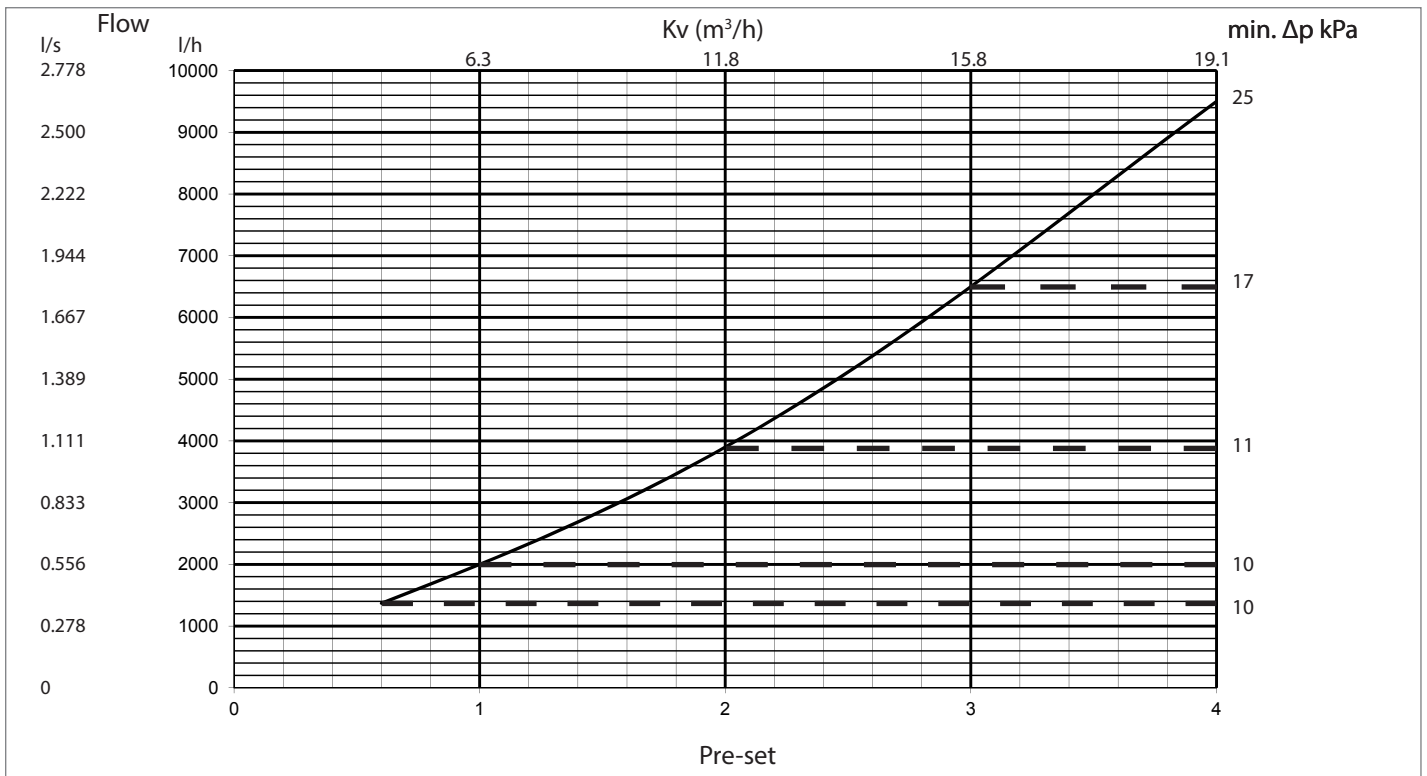

Frese OPTIMA Compact · DN50

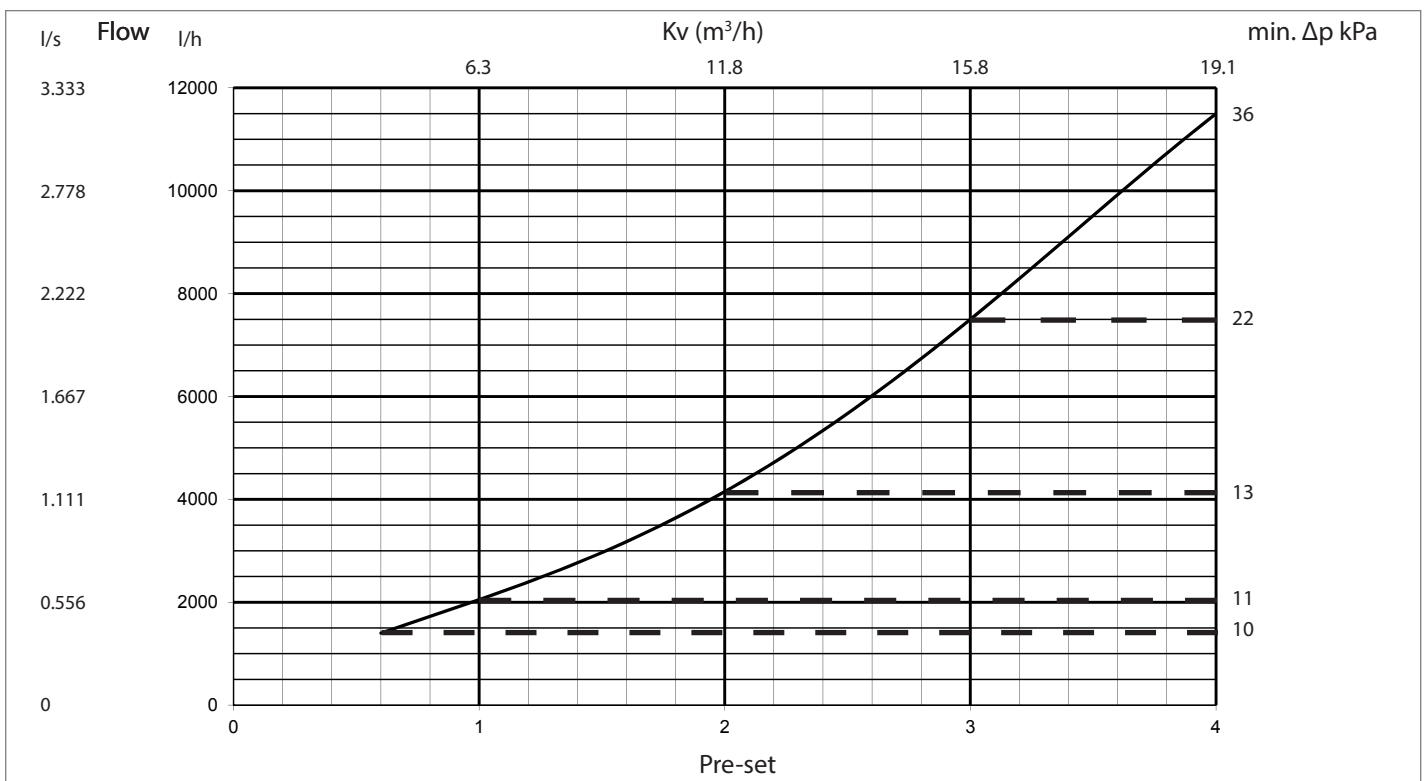

Frese OPTIMA Compact DN10-DN50 - pressure independent balancing & control valve

Setting and Flow

OPTIMA Compact Low 2,5 DN10/15				OPTIMA Compact Low 5,0 DN10/15			OPTIMA Compact High 2,5 DN15/20		
Pre-set	Flow l/h	Flow l/s	Flow gpm	Flow l/h	Flow l/s	Flow gpm	Flow l/h	Flow l/s	Flow gpm
0.5	30	0.008	0.13						
0.6	35	0.010	0.15	65	0.018	0.29	100	0.028	0.44
0.8	45	0.012	0.20	83	0.023	0.37	128	0.036	0.56
1.0	54	0.015	0.24	101	0.028	0.44	156	0.043	0.69
1.2	64	0.018	0.28	119	0.033	0.52	184	0.051	0.81
1.4	74	0.020	0.32	137	0.038	0.60	212	0.059	0.93
1.6	83	0.023	0.37	155	0.043	0.68	240	0.067	1.06
1.8	93	0.026	0.41	173	0.048	0.76	268	0.074	1.18
2.0	103	0.029	0.45	191	0.053	0.84	296	0.082	1.30
2.2	113	0.031	0.50	209	0.058	0.92	324	0.090	1.42
2.4	122	0.034	0.54	226	0.063	1.00	351	0.098	1.55
2.6	132	0.037	0.58	244	0.068	1.08	379	0.105	1.67
2.8	142	0.039	0.62	262	0.073	1.15	407	0.113	1.79
3.0	151	0.042	0.67	280	0.078	1.23	435	0.121	1.92
3.2	161	0.045	0.71	298	0.083	1.31	463	0.129	2.04
3.4	171	0.047	0.75	316	0.088	1.39	491	0.136	2.16
3.6	181	0.050	0.79	334	0.093	1.47	519	0.144	2.29
3.8	190	0.053	0.84	352	0.098	1.55	547	0.152	2.41
4.0	200	0.056	0.88	370	0.103	1.63	575	0.160	2.53

OPTIMA Compact High 5,0 DN15/20				OPTIMA Compact High 5,5 DN20			OPTIMA Compact Low 5,5 DN25		
Pre-set	Flow l/h	Flow l/s	Flow gpm	Flow l/h	Flow l/s	Flow gpm	Flow l/h	Flow l/s	Flow gpm
0.6	220	0.061	0.97	300	0.083	1.32	280	0.078	1.23
0.8	285	0.079	1.26	395	0.110	1.74	356	0.099	1.57
1.0	351	0.097	1.54	480	0.133	2.11	430	0.119	1.89
1.2	416	0.116	1.83	558	0.155	2.46	502	0.139	2.21
1.4	481	0.134	2.12	632	0.176	2.78	574	0.159	2.53
1.6	546	0.152	2.41	704	0.196	3.10	647	0.180	2.85
1.8	612	0.170	2.69	776	0.216	3.42	722	0.201	3.18
2.0	677	0.188	2.98	850	0.236	3.74	800	0.222	3.52
2.2	742	0.206	3.27	927	0.258	4.08	881	0.245	3.88
2.4	808	0.224	3.56	1008	0.280	4.44	967	0.269	4.26
2.6	873	0.242	3.84	1094	0.304	4.82	1057	0.294	4.65
2.8	938	0.261	4.13	1185	0.329	5.22	1151	0.320	5.07
3.0	1004	0.279	4.42	1280	0.356	5.64	1250	0.347	5.50
3.2	1069	0.297	4.71	1380	0.383	6.07	1353	0.376	5.96
3.4	1134	0.315	4.99	1483	0.412	6.53	1460	0.406	6.43
3.6	1199	0.333	5.28	1589	0.441	6.99	1571	0.436	6.92
3.8	1265	0.351	5.57	1695	0.471	7.46	1685	0.468	7.42
4.0	1330	0.369	5.85	1800	0.500	7.93	1800	0.500	7.93

OPTIMA Compact High 5,5 DN25L				OPTIMA Compact DN32		
Pre-set	Flow l/h	Flow l/s	Flow gpm	Flow l/h	Flow l/s	Flow gpm
0.6	600	0.167	2.64	550	0.153	2.42
0.8	777	0.216	3.42	753	0.209	3.32
1.0	954	0.265	4.20	956	0.266	4.21
1.2	1131	0.314	4.98	1159	0.322	5.10
1.4	1308	0.363	5.76	1362	0.378	6.00
1.6	1485	0.413	6.54	1565	0.435	6.89
1.8	1662	0.462	7.32	1768	0.491	7.79
2.0	1839	0.511	8.10	1971	0.548	8.68
2.2	2016	0.560	8.88	2174	0.604	9.57
2.4	2193	0.609	9.66	2377	0.660	10.47
2.6	2370	0.658	10.44	2580	0.717	11.36
2.8	2547	0.708	11.22	2783	0.773	12.26
3.0	2724	0.757	12.00	2986	0.829	13.15
3.2	2901	0.806	12.78	3189	0.886	14.04
3.4	3078	0.855	13.55	3392	0.942	14.94
3.6	3255	0.904	14.33	3595	0.999	15.83
3.8	3432	0.953	15.11	3798	1.055	16.73
4.0	3609	1.003	15.89	4001	1.111	17.62

Frese OPTIMA Compact DN10-DN50 - pressure independent balancing & control valve

Setting and Flow

Pre-set	OPTIMA Compact DN40			OPTIMA Compact DN50		
	Flow l/h	Flow l/s	Flow gpm	Flow l/h	Flow l/s	Flow gpm
0.6	1370	0.381	6.03	1400	0.389	6.16
0.8	1681	0.467	7.40	1724	0.479	7.59
1.0	2000	0.556	8.81	2050	0.569	9.03
1.2	2333	0.648	10.27	2393	0.665	10.54
1.4	2686	0.746	11.83	2766	0.768	12.18
1.6	3063	0.851	13.48	3178	0.883	13.99
1.8	3467	0.963	15.26	3638	1.011	16.02
2.0	3900	1.083	17.17	4150	1.153	18.27
2.2	4364	1.212	19.21	4717	1.310	20.77
2.4	4857	1.349	21.39	5339	1.483	23.51
2.6	5380	1.494	23.69	6014	1.671	26.48
2.8	5928	1.647	26.10	6737	1.871	29.66
3.0	6500	1.806	28.62	7500	2.083	33.02
3.2	7090	1.969	31.22	8295	2.304	36.52
3.4	7692	2.137	33.87	9108	2.530	40.10
3.6	8300	2.306	36.54	9925	2.757	43.70
3.8	8906	2.474	39.21	10729	2.980	47.24
4.0	9500	2.639	41.83	11500	3.194	50.63

Frese OPTIMA Compact DN10-DN50 - pressure independent balancing & control valve

Documentation formula

Valve ID (own choice)	Valve type	Dimension	Pre-setting	Verified Δp [kPa]	Min. Δp (see flow rate graph) [kPa]	Flow
Pump type		Regulation mode			Set point	
Installation						
Signature				Date		

Text for technical specifications

- The length of the modulating stroke shall be independent of flow setting.
- The modulation and flow setting shall be one combined unit with a linear modulating motion and a rotational flow setting motion.
- The valve characterization shall not be changed at different flow settings.
- The combined flow setting and modulating control unit shall be pressure independent.
- The Pressure Independent Control Valve shall contain a combined flow setting, differential pressure control and modulating bonnet assembly.
- The valve housing shall be hot stamped DZR brass DN10-32 and ductile iron DN40-50.
- The valve shall have a spring made of stainless steel, a Diaphragm made of HNBR and O-rings made of EPDM.
- The valve housing shall be PN25 rated and suitable for 120°C.
- The valve shall have a thread according to ISO 228.
- The valve shall have a maximum operating differential pressure of 800 kPa (8 Bar).
- The valve shall have an external adjustable analogue step less presetting scale from minimum to maximum flow.
- P/T plugs shall be available as an option.
- The valve shall be capable of closing against a maximum differential pressure of 600 kPa (6 bar) DN10 - DN25 and 800 kPa (8 bar) DN25L - DN50 with a leakage rate at maximum 0,01% of max rated volumetric flow and comply to EN1349 Class IV.

Frese A/S assumes no responsibility for errors, if any, in catalogues, brochures, and other printed matter. Frese A/S reserves the right to modify its products without prior notice, including already ordered products, if this does not alter existing specifications. All registered trademarks in this material are the property of Frese A/S. All rights reserved.

Frese A/S
 Sorøvej 8
 DK- 4200 Slagelse
 Tel: +45 58 56 00 00
 Fax: +45 58 56 00 91
 info@frese.dk



EN Frese OPTIMA Compact DN10-DN50 AUG 16