

PRO-INNA-DOR

Fire-resistant internal
steel doors

MADE IN
BRITAIN



STEEL DOORS
FOR THE
REAL WORLD



FIRE DOORS

Available with
60, 120 and 240 mins
fire protection

TESTED TO
BS 476 Parts 20 & 22
BS EN 1634



PROFAB

WALL ACCESS



Raising Standards
Safety Assured



advancing architectural ironmongery

PRO-INNA-DOR

Fire-resistant internal steel doors

Profab Access have successfully redesigned steel doors away from their original industrial roots to provide a highly cost-effective single solution offering an aesthetic design, durable construction and fire protection for up to 4 hours.

The doors, fitted in internal applications in a wide variety of wall constructions, are designed to protect personnel and property from the spread of flames and smoke. Profab Access doors offer substantial benefits over comparable timber doors in strength, durability & security. The range has been tested to **BS 476 Parts 20 & 22**, and **BS EN 1634**.

> VERSIONS

We offer three versions - each providing increased fire protection (latched or unlatched):

PRO-INNA-DOR60	PRO-INNA-DOR120	PRO-INNA-DOR240
UP TO 1 HOUR (60 minutes)	UP TO 2 HOURS (120 minutes)	UP TO 4 HOURS (240 minutes)

> DOOR LEAF

Production Sizes:

NB: Sizes quoted may exceed manufacturing limitations.

All fire resistant doors are custom made. The maximum size varies according to fire rating as shown below for Mild Steel and 316 or 304 Stainless Steel.

Door Type	Max Width	Max Height	Max Area	PRO-INNA-DOR60	PRO-INNA-DOR120	PRO-INNA-DOR240
Single Doors Latched (Single Swing)	mm	mm	m ²	1370	1370	1370
				2830	2830	2830
				4.0	4.0	3.56
Single Doors Unlatched (Single Swing)	mm	mm	m ²	1300	1300	1300
				2500	2500	2500
				2.96	2.96	2.96
Double Doors (Single Swing - latched or unlatched, equal or unequally split)	mm	mm	m ²	2650	2650	2650
				2830	2830	2830
				4.0	4.0	3.56
Double Doors (Double Swing - latched or unlatched, equal or unequally split)	mm	mm	m ²	TBC	TBC	TBC
				TBC	TBC	TBC
				TBC	TBC	TBC

Thickness:	54mm
Material:	1.2mm Corrosion resistant Magnelis® sheets as standard with a variety of colours and finishes available.
Infill:	Self support resin impregnated honeycomb core with option of mineral wool available for improved acoustic performance.
Construction:	A non welded construction from 2 skins of Magnelis® folded around a rigid core. Stainless steel 240minute fire rated doors must be fitted with a 'Z' and astragal section to form a rebated meeting stile.

> DOOR FRAME

Construction:	Folded from 1.5mm Magnelis®. Screw and tab construction with 4 no adjustable fixing feet per jamb. Variable sub frame supplied as standard to accommodate site tolerance of -0/+30mm. Frame is fitted with 3 no class 13 hinges with 2 no dog bolts
----------------------	--

Profile:

Types A & B available in both Inward & Outward Opening Versions.

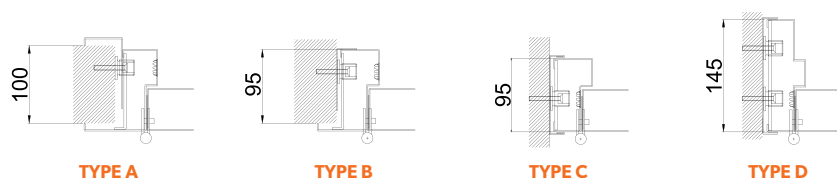

> WALL CONSTRUCTION

Construction

All Profab Access Fire Doors (PRO-INNA-DOR 60, 120 & 240) can be used in all forms of Masonry, Concrete and Flexible Stud Wall (cold wall style). When using Timber or Steel Stud Walls the client must ensure they have adequate evidence that the wall can support steel fire doors under fire conditions. 120 & 240 rated Stud Wall constructions should have the walls' reveal face protected by a fire resting board to protect the wall construction.

Types:

> THRESHOLD

Standard

15mm aluminium (DDA compliant)

Standard

5mm aluminium driveable (DDA compliant)

No threshold

Optional

15mm steel pressed rebated threshold

> VISION PANELS

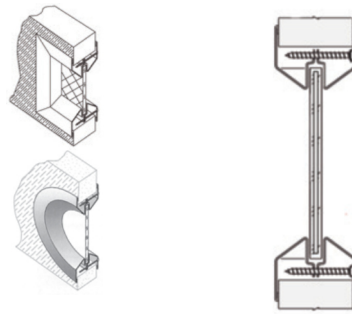
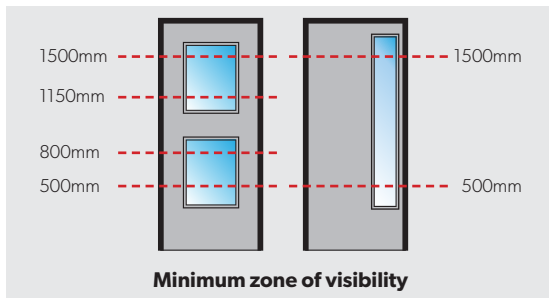

Standard Vision Panels - max size 508x1524mm per leaf. Please contact Sales for other options.

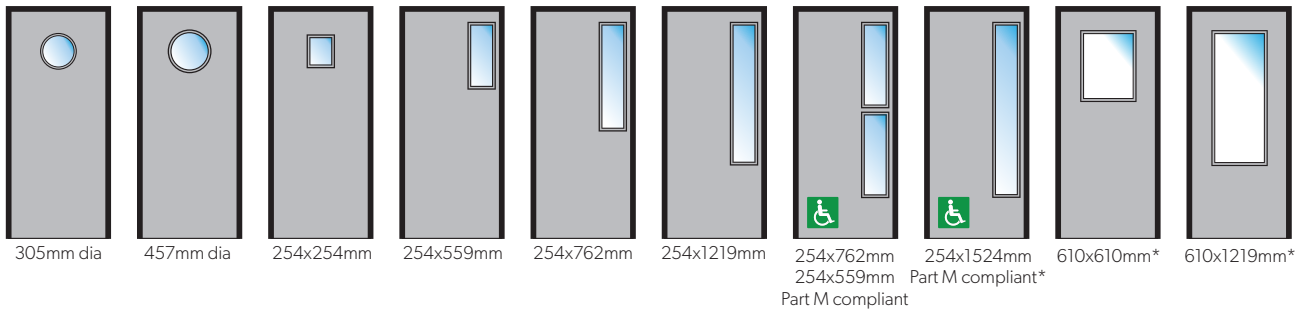

PRO-INNA-DOR 60

PRO-INNA-DOR 120

PRO-INNA-DOR 240

*Exceed maximum area for PRO-INNA-DOR 240 and cannot be used at that rating.

Permitted panel sizes: SSS = Standard Stainless Steel	Material	PRO-INNA-DOR 60		PRO-INNA-DOR 120		PRO-INNA-DOR 240	
		SSS	Magnelis®	SSS	Magnelis®	SSS	Magnelis®
Max Width mm		396	610	396	610	214	214
Max Height mm		1631	1854	1631	1854	1483	1483
Max Area m ²		0.35	0.8	0.35	0.8	0.32	0.32
Standard glazings available: Other configurations and sizes available – please contact the Sales Office.		8mm Firelite Safety*		8mm Firelite Safety*		8mm Firelite Safety*	

> FINISHES

Standard

Polyester Powder Coated from Standard Colour Range

Optional

Polyester Powder Coated from Non-Standard Colour Range

PVC Laminate from Standard Range





Woodgrain PVC Laminate

Stainless Steel Brushed, Polished or Patterned

Unfinished for site finishing

> LOUVRE PANELS

Construction:	Consists of an intumescent block grille only 14mm thick within the door leaf and an FDLS two-part steel louvre set which fixes to both sides of the door and sandwiches the FB intumescent block. 18g Galvanised steel frame louvre blades. (Stainless steel Grade 304 and Grade 316 available to order.)
Applications:	Designed to be used on fire rated doors fitted to rooms that require ventilation. A standard louvre will allow ventilation but will also allow the passage of flames and smoke, but a Fire Block Louvre System will maintain the integrity of fire doors and prevent the spread of flames. Examples are doors to plant rooms, stores, computer rooms, changing facilities and manufacturing areas. In fact, any area that requires ventilation but is protected by a fire rated door.

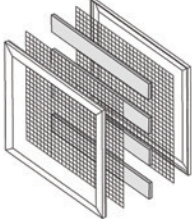
		PRO-INNA-DOR 60	PRO-INNA-DOR 120	PRO-INNA-DOR 240
Permitted panel sizes:	Max Width mm	610	610	610
	Max Height mm	610	610	610
	Max Area m ²	0.4	0.4	0.35
Allowed panels by relevant British Standard:	 457 x 457 mm lower	BS 476 BS EN 1634	BS 476 BS EN 1634	BS 476 BS EN 1634
	 457 x 457 mm upper	BS 476	BS 476	BS 476
	 457 x 457 mm upper and lower	BS 476	BS 476	
	 610 x 610 mm lower	BS 476 BS EN 1634	BS 476 BS EN 1634	BS EN 1634
	 610 x 610 mm upper	BS 476	BS 476	
				

> SIDE AND OVER PANEL ARRANGEMENTS

Construction:	Panels can be solid or glazed.
Applications:	Hinged panels, flush or glazed. Other glazing arrangements can be fitted subject to satisfactory evidence of testing in a steel door. Please consult the Sales office with specific requirements

Solid permitted overpanel sizes (fixed and hinged):	Max Height mm	2000	2000	2000
	Removable Transom	Yes	Yes	Yes
Permitted sidepanel sizes:	Max Width mm	1300	1300	1300
	Max Height mm	2830	2830	2830
Permitted glazed overpanel and sidepanel sizes:				
6mm Vetroflam/6mm Spacer/6mm Vetroflam:	Max Height mm	2000	2000	
	Max Area m ²	4.08	3.53	
8mm Firelite Safety:	Max Height mm	2060	2060	2060
	Max Area m ²	2.88	2.88	2.88

> REGULATORY REQUIREMENTS FOR FIRE TESTING

The Building Regulations for England and Wales Approved document B (Fire Safety, Appendix B) requires that all fire doors should have the appropriate performance:

A. By their performance under test to:

BS 476: Fire test on building materials and structures, Part 22 (Methods for determination of the fire resistance of non-loadbearing elements for a period of minutes). OR

B. Part 2 Classification using data from fire resistance tests. They are tested to the relevant European method from the following:

BS EN 1634-1:200, Fire resistance tests for door and shutter assemblies, Part 1 (Fire doors and shutters).

The building regulations further states that: "Any test evidence used to substantiate the fire resistance rating of a door or shutter should be carefully checked to ensure that it adequately demonstrates compliance and is applicable to the complete installed assembly. Small differences in detail (such as glazing apertures,.....) may significantly affect the rating".

> VERIFICATION AND CERTIFICATION

All fire-resistant PRO-INNA-DOR's have been tested to both BS 476 and BS EN 1634.

All steel doors are manufactured strictly in accordance with ISO 9000.

We undertake a regular programme of testing which may modify the information contained depending on latest test evidence. For project specific requirements please contact the sales office on 01827 718222.

PROFAB ACCESS LTD, Riversdale House, Units C-D Riversdale Road, Carlyon Road Industrial Estate, Atherstone, Warwickshire, CV9 1FA

01827 718222

sales@profabaccess.com

www.profabaccess.com