

Hoardfast Standard PVC is a quick to install, modular, internal screening system that can be used free-standing with a range of support and stability options or fixed floor-to-ceiling. Hoardfast PVC comes in a range of heights up to 5m and can be purchased or hired.

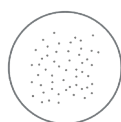

Reduce dust

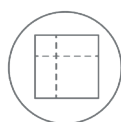

Create site office and welfare spaces



Reusable and sustainable



Quick installation



Cost effective



Next day delivery

FEATURES & BENEFITS

FEATURES	BENEFITS
Modular ready to install system	<ul style="list-style-type: none"> Quick, clean, easy installation saves time and money on site setup Easy to configure as required
Sustainable product that can be hired, reused and recycled	<ul style="list-style-type: none"> Pay for and use the product only for the time you need Save money by reusing the same panels and components on phased or multiple projects Reduced overall environmental impact for your project
Graded panel options	<ul style="list-style-type: none"> Choose a standard and price of panel to suit your project
Light weight panel	<ul style="list-style-type: none"> Easy to move around site
1.12m, 2.25m, 2.7m, 3m, 4m, 5m standard panels heights	<ul style="list-style-type: none"> Create quick floor to ceiling or free-standing partitions Easy to cut and configure as required
Next day delivery from large UK stock*	<ul style="list-style-type: none"> Get items to site when you need them to prevent delays
Easy fit single and double doors (with Digi lock)	<ul style="list-style-type: none"> Create restricted access to construction sites or site offices and welfare spaces

*Deliveries to mainland UK



All standard stock is dispatched using a next day delivery service and both hire and purchase options are available. Optional extras include; doors, vision panels and graphics.



TECHNICAL SPECIFICATIONS

Material composite	85% recycled PVC, 15% Virgin PVC, grey hollow fluted internal and solid white ridged external face
Connection method	Tongue and groove click together
Panel Fire rating	BS476 Class 1 Part 7 (Spread of Flame)
Standard panel heights	1.12m, 2.25m, 2.7m, 3m, 4m, 5m
Panel width	0.5m
Panel thickness	35mm (up to 2.7m), 50mm (3m-5m)
Support options	Floor-to-ceiling; supplied with u-channel fixings or Free-standing; equal, offset, universal, bolt down

TECHNICAL SPECIFICATIONS

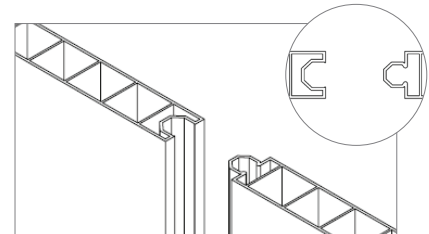

Panels are connected by knocking together the tongue and groove. Corner posts and T-sections are also available

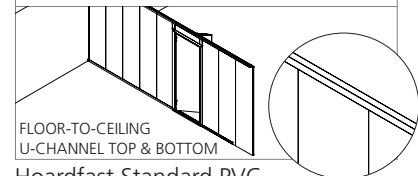
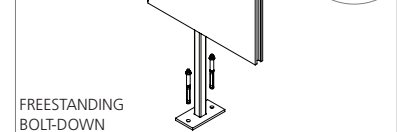
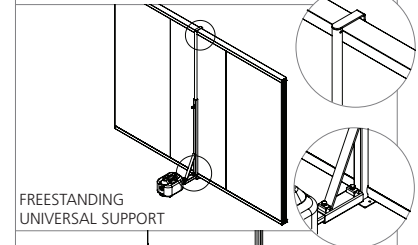
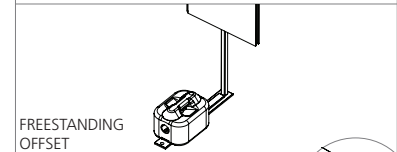
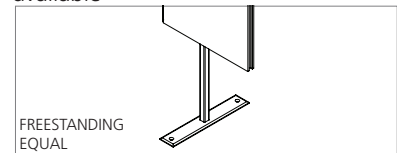

Hoardfast Standard PVC works with a range of Free-standing Stability options or install floor to ceiling supplied u-channels.

HOARDFAST SOLUTIONS ARE USED BY MANY INCLUDING...

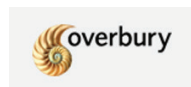

This fact sheet is for illustrative purposes only and based on the latest information at the time of print. Installation methods may vary depending on specific project requirements. Westgate reserve the right to make changes at any time without notice.

westgateuk.co.uk +44 (0)1785 242181 salesteam@westgateuk.co.uk

SINGLE AND DOUBLE DOORS

FEATURES	BENEFITS
Lift-off hinge	<ul style="list-style-type: none"> Quick to install and easily demountable
Available with Digilock	<ul style="list-style-type: none"> Increase access security
Chamfered threshold	<ul style="list-style-type: none"> Ensures ease of access i.e. trolleys etc
Double door is supplied with guide wheel	<ul style="list-style-type: none"> Maximum stability Robust, durable design
Aluminium frame	<ul style="list-style-type: none"> Contrast clearly distinguishes access
Clips into adjacent panels	<ul style="list-style-type: none"> Simple and easy to install No screws required



TECHNICAL SPECIFICATIONS

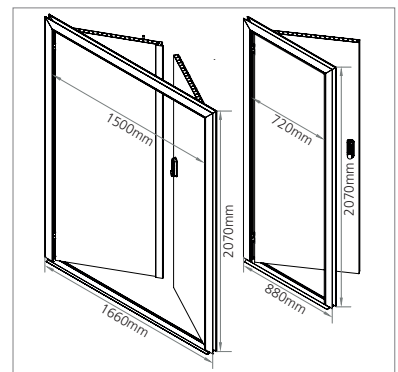

Double or single PVC doors

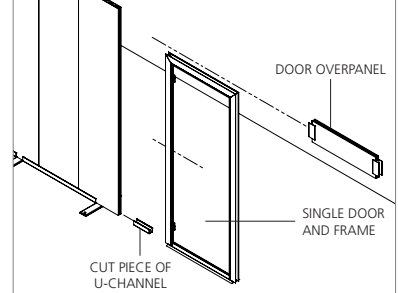

Insert the door as shown above

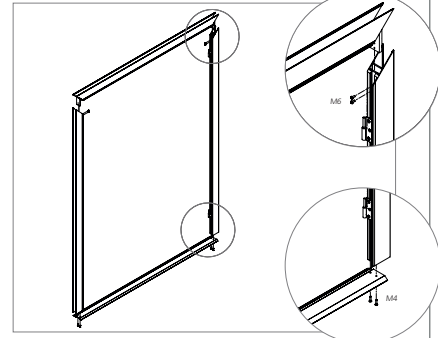

Aluminium frames are bolted together at all four corners. Single doors supplied preassembled. Double doors supplied with self-tapping screws for easy self-assembly on site.

TECHNICAL SPECIFICATIONS

Panel material composite	85% recycled PVC, 15% Virgin PVC, grey hollow fluted internal and solid white ridged external face
Frame material	Aluminium
Standard height	2070mm
External width	880mm (single door) 1660mm (double door)
Internal width	720mm (single door) 1500mm (double door)
Panel thickness	35mm

HOARDFAST SOLUTIONS ARE USED BY MANY INCLUDING...

This fact sheet is for illustrative purposes only and based on the latest information at the time of print. Installation methods may vary depending on specific project requirements. Westgate reserve the right to make changes at any time without notice.

SUPPORT OPTIONS

The Hoardfast Standard PVC system has a range of supports depending on your project requirement; from free-standing up to 3m with multiple stability options to a floor-to-ceiling fix up to 5m.

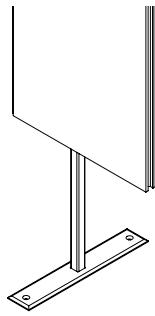
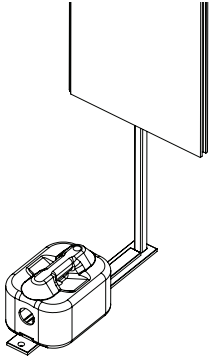
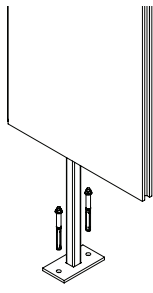
SUPPORT TYPE	SUPPORT SPECIFICATION	USED WITH: PANEL	USED WITH: PANEL HEIGHT
Equal (free-standing)	 <ul style="list-style-type: none"> • Self supporting up to 2.7m high • Support inserts into hollow flute of the panel • Support protrudes each side of panel by 210mm* 	Standard PVC	1.12m / 2.25m / 2.7m
Offset Weighted (free-standing)	 <ul style="list-style-type: none"> • For additional stability up to 2.7m high • Allows up to 3 x 16kg weights to be installed per support • Support inserts into hollow flute of the panel • Weights are secured with a bolt, washer and wingnut • Support protrudes one side of panel by 600mm (construction side)* 	Standard PVC	1.12m / 2.25m / 2.7m
Bolt Down (free-standing)	 <ul style="list-style-type: none"> • For a more stable and permanent solution up to 2.7m high • Can be secured to the floor • The support inserts into the hollow flute of the panel 	Standard PVC	1.12m / 2.25m / 2.7m

*based on use with 35mm thick panel

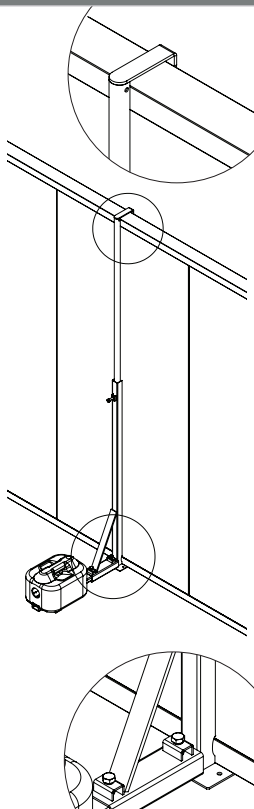
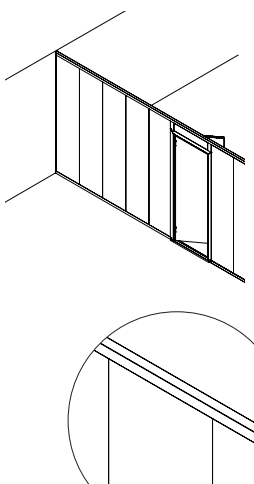
TYPE	SPECIFICATION	PANEL	PANEL HEIGHT
Universal (free-standing)	 <ul style="list-style-type: none"> • For maximum stability • Free-standing up to 3m high • Standard: allows up to 3 x 16kg weights per support (Protrudes 645mm construction side) • Long: will accommodate up to 6 x 16kg weights per support (Protrudes 900mm construction side) • System secured at base using a hooked in u-channel and at the top using a hooked over pole 	Standard PVC	2.25m / 2.7m / 3m
		Soundscreen	2.25m / 2.7m / 3.1m
		Firescreen	2.25m / 2.7m / 3.1m
		Flamescreen	2.25m / 2.7m
Floor-to-ceiling	 <ul style="list-style-type: none"> • Floor-to-ceiling fixed solution up to 5m high • Installed using supplied u-channels 	Budget PVC	2.7m / 3.5m / 4.8m
		Standard PVC	2.25m / 2.7m / 3m / 4m / 5m
		Soundscreen	2.25m / 2.7m / 3.1m
		Firescreen	2.25m / 2.7m / 3.1m / 3.5m / 4m / 4.5m
		Flamescreen	2.25m / 2.7m / 3.5m

This fact sheet is for illustrative purposes only and based on the latest information at the time of print. Installation methods may vary depending on specific project requirements. Westgate reserve the right to make changes at any time without notice.