



# The **Edging** Book



**Kinley**   
INSPIRED PLACES MADE POSSIBLE



**Kinley**  
Northpoint, Compass Park  
Staplecross, East Sussex  
TN32 5BS United Kingdom

t: +44 (0)1580 830688  
e: sales@kinley.co.uk

[kinley.co.uk](http://kinley.co.uk)

## Contents

<b>Designed to be better</b> .....	4
ExcelEdge – The Leading Edge	
<b>Support: The Kinley commitment</b> .....	5
Project support	
Specifier support	
Contractor support	
At your service	
<b>Choosing the right material</b> .....	6
<b>Aluminium edging</b> .....	8
AluExcel	
Aluminium angle edging .....	10
AllEdge	
Premium aluminium lawn edging .....	20
RoofEdge	
Perforated edging for green roof applications .....	24
RoofEdge Premium	
Premium edging for green roof applications .....	30
<b>Steel edging</b> .....	32
Borderline	
Steel lawn edging .....	34
HiGrade	
Heavy duty steel landscape edging .....	38
HiGrade Bespoke	
Bespoke 6 mm pre-formed steel panel system .....	42
Contour	
Heavy duty steel angle edging .....	46
<b>Gravel stabilisation panels</b> .....	50
Gravelrings	
Gravel stabilisation panels .....	51
<b>Case studies</b> .....	54
<b>How we can help you achieve</b> .....	64
<b>Our products</b> .....	66

## Designed to be Better

### ExcelEdge – The Leading Edge

Combining research and development with experience in the field Kinley Systems have expanded their range of landscape edgings from the recycled plastic products introduced in 2004 to become the most comprehensive selection available in the industry.

Aluminium and steel in numerous formats and finishes provide solutions for every situation where differing landscape surfaces meet and need to be defined.

To strength and durability, all ranges add simplicity of both design and installation. Discreet and smart, their effectiveness and low maintenance requirements ensure life-span cost benefits.

Everyone in the Kinley team is committed to the provision of service and support for specifiers, customers and contractors from initial enquiry, through speedy delivery, to final completion of the project.

Throughout Europe, and further afield, our logistics connections make fast deliveries, usually from stock, to avoid on-site delays.

The flowing curves to the paths in this project were easily created using flexible AluExcel aluminium edging profiles



## Support: The Kinley commitment

### Project Support

The Kinley Technical Sales Team welcomes the opportunity to support particular projects at any stage, from concept to handover, from choice of material to implementation on the ground.

The successful completion of your scheme, on time and on budget, is vitally important to us.

Satisfactorily resolving issues feeds into our programme of continuous improvement and development. Because an item isn't in the catalogue doesn't necessarily mean you can't have it!

### Specifier Support

The adoption of aluminium edgings and restraints has greatly widened the scope for the implementation of innovative and imaginative landscape design. Our technical sales team provides support, including CPD Seminars, CAD drawings and data sheets, as well as advice on specific product applications.

### Contractor Support

Our stock holding policy is focused on getting the landscape edgings you need onto your site on time. We'll need a little time to do that when specialised shapes and curves have to be pre-formed. We'll happily visit you on site or at your base for training or advice. We'll also welcome your suggestions for improving our service or our products.

### At Your Service

- Design Stage. Advice on choice of material and construction detail.
- Pre-forming requirements. The accuracy needed to achieve client satisfaction.
- Bespoke Fabrication of non-standard profiles
- Hostile Environment advice (Marine or industrial)
- Armacote™ durable powder coating – any (RAL) colour you like.

To book your free CPD presentation go to our website [kinley.co.uk](http://kinley.co.uk) or call us on **+44 (0)1580 830 688**

# Choosing the right material



## Aluminium

Aluminium has become established as the first choice in landscape edging. Its strength, flexibility, durability and lightness contribute to simple, easy installation and minimal maintenance. With easy manual formation of curves and gradients the time consuming base preparation associated with traditional kerbing is eliminated. Wet trades work (and drying time), and the mechanical handling of concrete kerbs and associated breakage risks no longer restrain the realisation of complex plans.

All ExcelEdge aluminium products are made from a minimum of 80% recycled aluminium which is 100% recyclable.

- AluExcel is the principal profile for commercial hard landscaping applications.
- AllEdge provides a smart, durable, low maintenance lawn edging.
- RoofEdge allows for lateral drainage and elegant surface boundaries on green roofs.

## Steel

For prestigious projects and those subject to heavy traffic ExcelEdge steel edgings with their great range of grades, formats and finishes have deservedly earned loyalty among specifiers and contractors.

- Borderline edgings for both hard and soft landscaping applications.
- HiGrade is the heavy duty choice for special finishes and raised boundaries.
- Contour is a superbly robust, rolled top, edge restraint for public realm and other high traffic areas.

Preformed, bespoke HiGrade steel edging in CorTen A creates a stunning visual result in this school courtyard.



	Soft landscape lawns and borders	Soft/hard landscape e.g. paving and lawns	Hard landscape Asphalt and paving	Material	Strength rating 1= weakest 10= strongest	Flexibility rating 1= inflexible 10= very flexible	Section lengths	Cost relativity 1= low cost 10= high cost
<b>Aluminium edging products</b>								
AluExcel Aluminium angle edging	X	✓	✓	Aluminium	5-10*	6-8*	2.5 m	5-7
AllEdge Premium aluminium lawn edging	✓	✓	X	Aluminium	5	8	2.5 m	6
RoofEdge Perforated edging for green roof applications	✓	✓	X	Aluminium	4-5	8	2.4 m	7
RoofEdge Premium Premium edging for green roof applications	✓	✓	X	Aluminium	7	0	2.4 m	7
<b>Steel edging products</b>								
Borderline Steel lawn edging	✓	✓	✓	Steel	6-8*	6-8*	2.0 m	5-7
HiGrade Heavy duty steel landscape edging	✓	✓	✓	Steel	8-10*	3-7*	3.0 m	6-10
Contour Heavy duty steel angle edging	X	✓	✓	Steel	8-10	3-7	2.5 m	6-10

### Important notes on the use of this table:

The table is intended only to be used as a general guide. Due to the many different landscape applications available, installation methods may vary according to specific requirements. Please ensure you check with our technical team if you have any questions. Further installation details may also be downloaded from our Resource Centre.

Any strength ratings given are relative and are subject to correct installation methods and normal intended usage\* depending on specific profile height and thickness selected.

# Aluminium edging

## ExcelEdge AllEdge

Premium aluminium  
lawn edging

20

30

## ExcelEdge RoofEdge Premium

Premium edging for  
green roof applications

## ExcelEdge AluExcel

Aluminium angle  
edging

10

24

## ExcelEdge RoofEdge

Perforated edging for  
green roof applications

# ExcelEdge AluExcel

Aluminium angle edging



The ultimate commercial landscape edging for hard surfaces. AluExcel design features benefit from state of the art technology ensuring maximum flexibility consistent with optimum strength and durability.

### Use it with:

- Asphalt
- Blocks and pavers
- Imprinted & plain concrete
- Resin bound & loose gravels
- Wetpour rubber & other safety surfacing



Standard installation method between two hard interfaces on a compacted sub-base.

For further technical installation detail see page 18 or go to the video on our website [kinley.co.uk](http://kinley.co.uk)

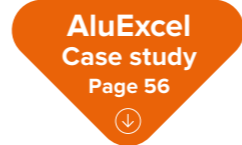

### Advantages:

- Create clean curved or straight lines
- Fast, simple installation saves time and money
- Strong durable alloy won't rust
- Recycled aluminium is lightweight and easy to handle
- Works between all hard/soft surface types





## ExcelEdge AluExcel

Profile heights:  
18 mm - 150 mm



Made in the UK  
Part recycled  
100% recyclable



### 18 mm profile height

#### AE18FM

Aluminium angle **flexible** edge restraint. Supplied with 1 connector strip.

Profile height	<b>18 mm</b>	Top edge bead thickness	<b>5 mm</b>
Length	<b>2.5 m</b>	Weight per length	<b>0.58 kgs</b>
Horizontal width	<b>30 mm</b>	Finish	<b>Mill</b>
Thickness	<b>3 mm</b>	(Fixings not supplied)	



#### AE18RM

Aluminium angle **rigid** edge restraint. Supplied with 1 connector strip.

Profile height	<b>18 mm</b>	Top edge bead thickness	<b>5 mm</b>
Length	<b>2.5 m</b>	Weight per length	<b>0.58 kgs</b>
Horizontal width	<b>30 mm</b>	Finish	<b>Mill</b>
Thickness	<b>3 mm</b>	(Fixings not supplied)	



### 25 mm profile height

#### AE25FM

Aluminium angle **flexible** edge restraint. Supplied with 1 connector strip.

Profile height	<b>25 mm</b>	Top edge bead thickness	<b>5 mm</b>
Length	<b>2.5 m</b>	Weight per length	<b>0.75 kgs</b>
Horizontal width	<b>32 mm</b>	Stakes per length	<b>5</b>
Thickness	<b>3 mm</b>	Finish	<b>Mill</b>

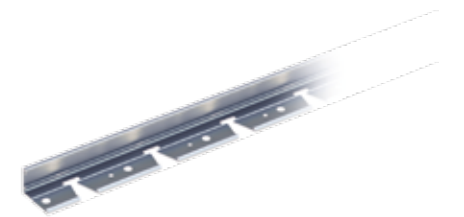

#### AE25RM

Aluminium angle **rigid** edge restraint. Supplied with 1 connector strip.

Profile height	<b>25 mm</b>	Top edge bead thickness	<b>5 mm</b>
Length	<b>2.5 m</b>	Weight per length	<b>0.75 kgs</b>
Horizontal width	<b>32 mm</b>	Stakes per length	<b>5</b>
Thickness	<b>3 mm</b>	Finish:	<b>Mill</b>

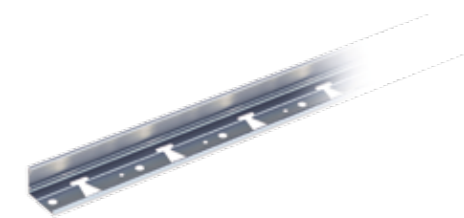

#### AE25CI

**90° Internal** corner.  
Supplied with 1 connector strip.

Length **150 mm x 150 mm**



#### AE25CE

**90° External** corner.  
Supplied with 1 connector strip.

Length **150 mm x 150 mm**



### 40 mm profile height

#### AE40FM

Aluminium angle **flexible** edge restraint. Supplied with 1 connector strip.

Profile height	<b>40 mm</b>	Top edge bead thickness	<b>6 mm</b>
Length	<b>2.5 m</b>	Weight per length	<b>1.3 kgs</b>
Horizontal width	<b>45 mm</b>	Stakes per length	<b>5</b>
Thickness	<b>3 mm</b>	Finish	<b>Mill</b>

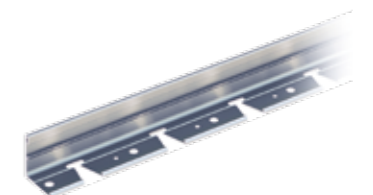

#### AE40RM

Aluminium angle **rigid** edge restraint. Supplied with 1 connector strip.

Profile height	<b>40 mm</b>	Top edge bead thickness	<b>6 mm</b>
Length	<b>2.5 m</b>	Weight per length	<b>1.3 kgs</b>
Horizontal width	<b>45 mm</b>	Stakes per length	<b>5</b>
Thickness	<b>3 mm</b>	Finish	<b>Mill</b>

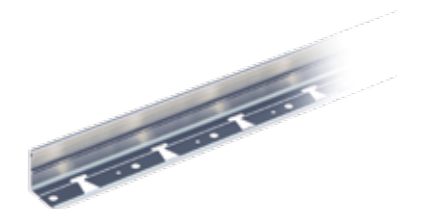

#### AE40CI

**90° Internal** corner.  
Supplied with 1 connector strip

Length **150 mm x 150 mm**



#### AE40CE

**90° External** corner.  
Supplied with 1 connector strip

Length **150 mm x 150 mm**





50 mm profile height

**AE50FM**

Aluminium angle **flexible** edge restraint. Supplied with 1 connector strip.

Profile height	<b>50 mm</b>	Top edge bead thickness	<b>6 mm</b>
Length	<b>2.5 m</b>	Weight per length	<b>1.45 kgs</b>
Horizontal width	<b>45 mm</b>	Stakes per length	<b>5</b>
Thickness	<b>4 mm</b>	Finish	<b>Mill</b>

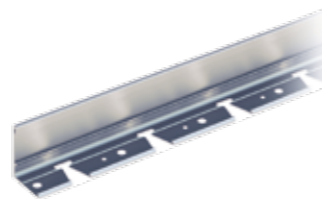

**AE50RM**

Aluminium angle **rigid** edge restraint. Supplied with 1 connector strip.

Profile height	<b>50 mm</b>	Top edge bead thickness	<b>6 mm</b>
Length	<b>2.5 m</b>	Weight per length	<b>1.45 kgs</b>
Horizontal width	<b>45 mm</b>	Stakes per length	<b>5</b>
Thickness	<b>4 mm</b>	Finish	<b>Mill</b>

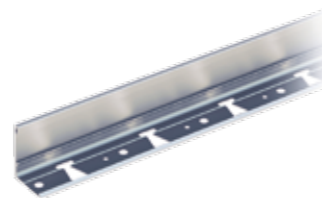

**AE50CI**

**90° Internal** corner. Supplied with 1 connector strip

Length **150 mm x 150 mm**



**AE50CE**

**90° External** corner. Supplied with 1 connector strip

Length **150 mm x 150 mm**



65 mm profile height

**AE65FM**

Aluminium angle **flexible** edge restraint. Supplied with 1 connector strip.

Profile height	<b>65 mm</b>	Top edge bead thickness	<b>6 mm</b>
Length	<b>2.5 m</b>	Weight per length	<b>1.45 kgs</b>
Horizontal width	<b>45 mm</b>	Stakes per length	<b>5</b>
Thickness	<b>4 mm</b>	Finish	<b>Mill</b>

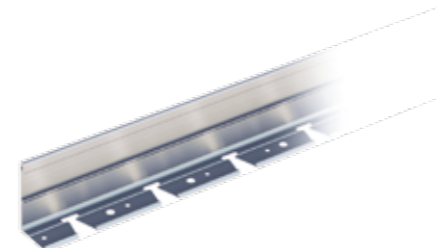

**AE65RM**

Aluminium angle **rigid** edge restraint. Supplied with 1 connector strip.

Profile height	<b>65 mm</b>	Top edge bead thickness	<b>6 mm</b>
Length	<b>2.5 m</b>	Weight per length	<b>1.45 kgs</b>
Horizontal width	<b>45 mm</b>	Stakes per length	<b>5</b>
Thickness	<b>4 mm</b>	Finish	<b>Mill</b>

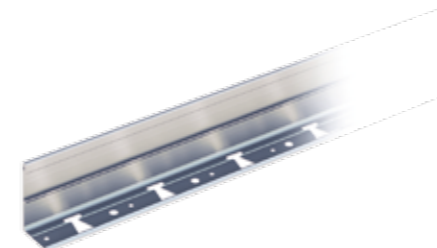

**AE65CI**

**90° Internal** corner. Supplied with 1 connector strip

Length **150 mm x 150 mm**



**AE65CE**

**90° External** corner. Supplied with 1 connector strip

Length **150 mm x 150 mm**



75 mm profile height

**AE75FM**

Aluminium angle **flexible** edge restraint. Supplied with 1 connector strip.

Profile height	<b>75 mm</b>	Top edge bead thickness	<b>6.5 mm</b>
Length	<b>2.5 m</b>	Weight per length	<b>2.35 kgs</b>
Horizontal width	<b>70 mm</b>	Stakes per length	<b>5</b>
Thickness	<b>4 mm</b>	Finish	<b>Mill</b>

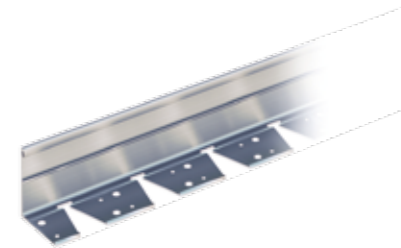

**AE75RM**

Aluminium angle **rigid** edge restraint. Supplied with 1 connector strip.

Profile height	<b>75 mm</b>	Top edge bead thickness	<b>6.5 mm</b>
Length	<b>2.5 m</b>	Weight per length	<b>2.45 kgs</b>
Horizontal width	<b>70 mm</b>	Stakes per length	<b>5</b>
Thickness	<b>4 mm</b>	Finish	<b>Mill</b>

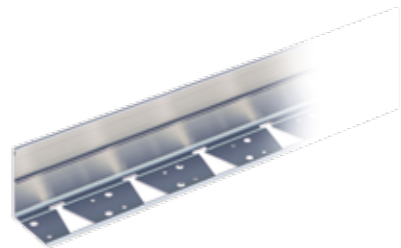

**AE75CI**

**90° Internal** corner. Supplied with 1 connector strip.

Length **150 mm x 150 mm**



**AE75CE**

**90° External** corner. Supplied with 1 connector strip.

Length **150 mm x 150 mm**



100 mm profile height

**AE100FM**

Aluminium angle **flexible** edge restraint. Supplied with 1 connector strip.

Profile height	<b>100 mm</b>	Top edge bead thickness	<b>6.5 mm</b>
Length	<b>2.5 m</b>	Weight per length	<b>3.1 kgs</b>
Horizontal width	<b>70 mm</b>	Stakes per length	<b>5</b>
Thickness	<b>4 mm</b>	Finish	<b>Mill</b>



**AE100RM**

Aluminium angle **rigid** edge restraint. Supplied with 1 connector strip.

Profile height	<b>100 mm</b>	Top edge bead thickness	<b>6.5 mm</b>
Length	<b>2.5 m</b>	Weight per length	<b>3.2 kgs</b>
Horizontal width	<b>70 mm</b>	Stakes per length	<b>5</b>
Thickness	<b>4 mm</b>	Finish	<b>Mill</b>



**AE100CI**

**90° Internal** corner. Supplied with 1 connector strip.

Length **150 mm x 150 mm**



**AE100CE**

**90° External** corner. Supplied with 1 connector strip.

Length **150 mm x 150 mm**







## 120 mm profile height

### AE120FM

Aluminium angle **flexible** edge restraint. Supplied with 1 connector strip.

Profile height	<b>120 mm</b>	Top edge bead thickness	<b>7 mm</b>
Length	<b>2.5 m</b>	Weight per length	<b>4.36 kgs</b>
Horizontal width	<b>70 mm</b>	Stakes per length	<b>5</b>
Thickness	<b>4 mm</b>	Finish	<b>Mill</b>



### AE120RM

Aluminium angle **rigid** edge restraint. Supplied with 1 connector strip.

Profile height	<b>120 mm</b>	Top edge bead thickness	<b>7 mm</b>
Length	<b>2.5 m</b>	Weight per length	<b>4.38 kgs</b>
Horizontal width	<b>70 mm</b>	Stakes per length	<b>5</b>
Thickness	<b>4 mm</b>	Finish	<b>Mill</b>

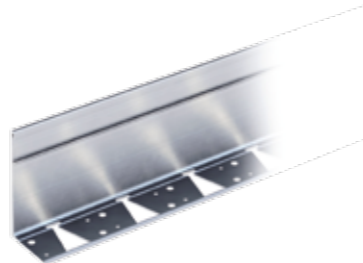

### AE120CI

**90° Internal** corner. Supplied with 1 connector strip.

Length **150 mm x 150 mm**



### AE120CE

**90° External** corner. Supplied with 1 connector strip.

Length **150 mm x 150 mm**



## 150 mm profile height

### AE150FM

Aluminium angle **flexible** edge restraint. Supplied with 1 connector strip.

Profile height	<b>150 mm</b>	Top edge bead thickness	<b>8 mm</b>
Length	<b>2.5 m</b>	Weight per length	<b>5.55 kgs</b>
Horizontal width	<b>70 mm</b>	Stakes per length	<b>5</b>
Thickness	<b>4.5 mm</b>	Finish	<b>Mill</b>



### AE150RM

Aluminium angle **rigid** edge restraint. Supplied with 1 connector strip.

Profile height	<b>150 mm</b>	Top edge bead thickness	<b>8 mm</b>
Length	<b>2.5 m</b>	Weight per length	<b>5.55 kgs</b>
Horizontal width	<b>70 mm</b>	Stakes per length	<b>5</b>
Thickness	<b>4.5 mm</b>	Finish	<b>Mill</b>

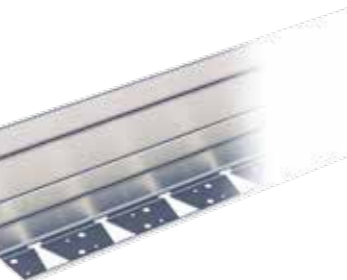

### AE150CI

**90° Internal** corner. Supplied with 1 connector strip.

Length **150 mm x 150 mm**



### AE150CE

**90° External** corner. Supplied with 1 connector strip.

Length **150 mm x 150 mm**



## 150 mm reverse profile height

### AE150FMR

Aluminium angle **flexible reverse** profile edge restraint. Supplied with 1 connector strip.

Profile height	<b>150 mm</b>	Top edge bead thickness	<b>8 mm</b>
Length	<b>2.5 m</b>	Weight per length	<b>5.55 kgs</b>
Horizontal width	<b>70 mm</b>	Stakes per length	<b>5</b>
Thickness	<b>4.5 mm</b>	Finish	<b>Mill</b>

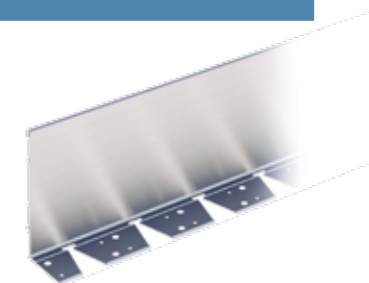

### AE150RMR

Aluminium angle **rigid reverse** profile edge restraint. Supplied with 1 connector strip.

Profile height	<b>150 mm</b>	Top edge bead thickness	<b>8 mm</b>
Length	<b>2.5 m</b>	Weight per length	<b>5.55 kgs</b>
Horizontal width	<b>70 mm</b>	Stakes per length	<b>5</b>
Thickness	<b>4.5 mm</b>	Finish	<b>Mill</b>

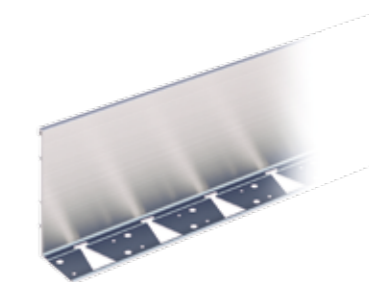

## Accessories

### AECSS

Small connector strip.

Sold as an accessory to **18 mm – 40 mm** high edging



### AECSL

Large connector strip.

Sold as an accessory to **50 mm – 150 mm** high edging



### SS250B

Spiral fixings stakes.

Come as a set of 5.



### AESG30

AluExcel Synthetic Grass Edge. **NEW**

Only suitable for the **50 mm – 150 mm** high AluExcel profiles.



## Additional Services

### Bespoke Fabrication

Where circles or symmetrical curved shapes are required we recommend utilising our pre-forming service to ensure an accurate result.



### Powder Coating

For that extra special result we can also apply our Armacote™ powder coating to any RAL colour to provide the ultimate outstanding result.



For more information about our project support services please contact our technical team on **+44 (0)1580 830 688** or visit [kinley.co.uk](http://kinley.co.uk)

# AluExcel standard installation

This diagram shows a standard installation method on a compacted MOT Type 1 sub-base between a hard and soft landscape surfaces. No concrete is necessary which means that installation is fast and easy and adjacent planting or lawn can grow right up to the edge.

For further technical installation detail go to our website [kinley.co.uk](http://kinley.co.uk)

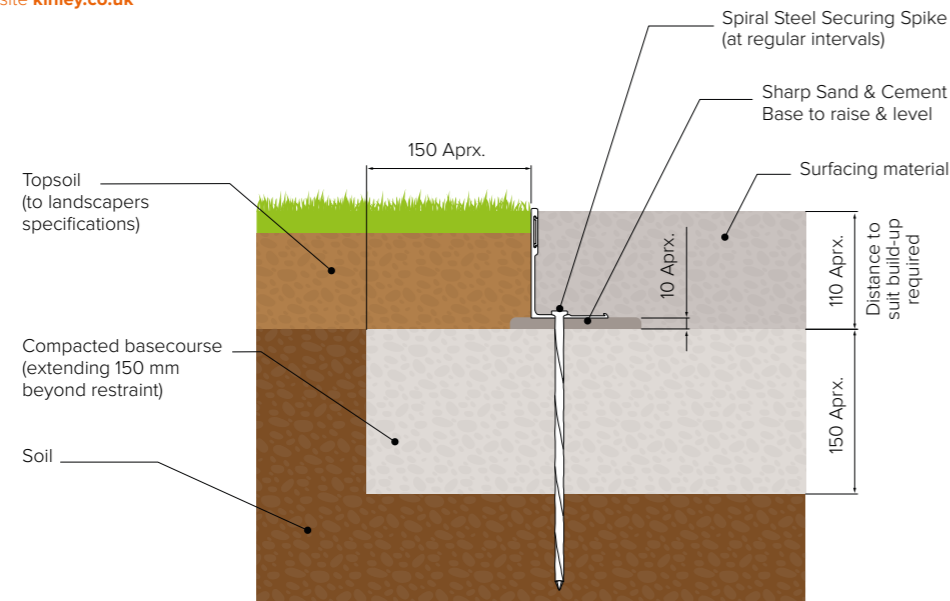

The AluExcel edging butts up at the ends and is joined using a connection piece. This image shows how the edging is installed using the spiral fixing stakes hit down through the foot into the compacted sub-base.



# AluExcel installation with AESG30

**NEW**

This diagram shows a typical installation of our AluExcel edging system, complete with our synthetic grass attachment, between soft landscapes. The attachment provides the perfect 'ledge' to glue the synthetic grass to. The attachment simply slides into the AluExcel profile. This attachment is suitable for the 50mm high edging and above.

For further technical installation detail go to our website [kinley.co.uk](http://kinley.co.uk)

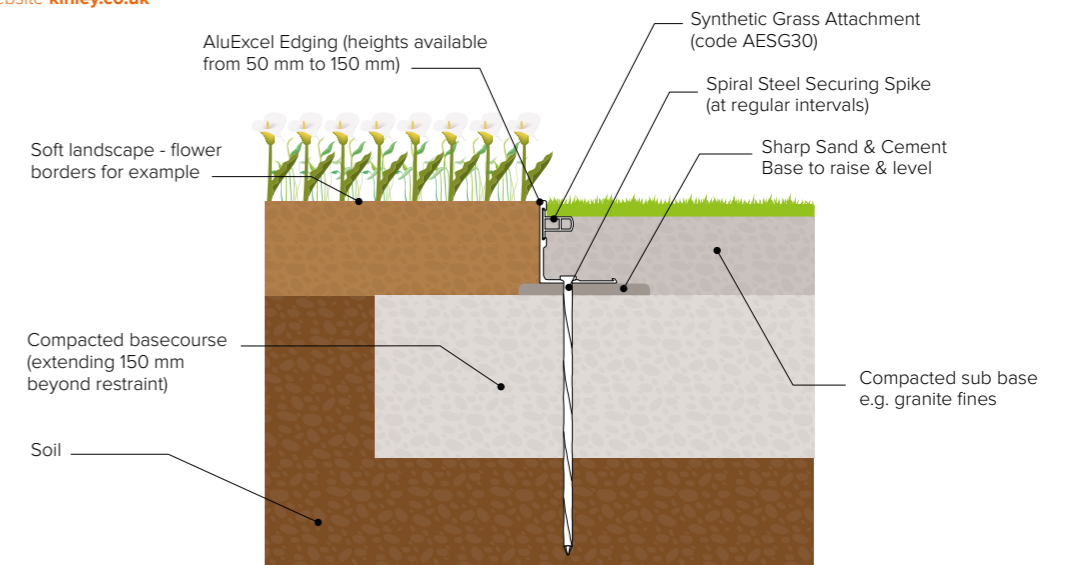

This image demonstrates the excellent end result achieved using the AluExcel edging system in conjunction with synthetic grass.



# ExcelEdge AllEdge

Premium aluminium lawn edging

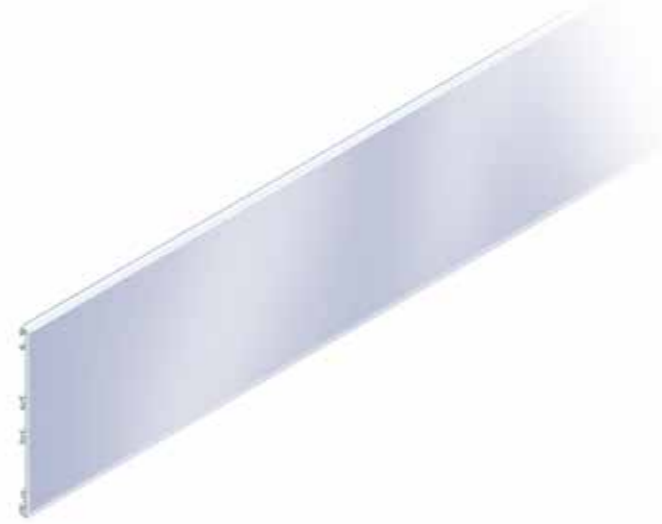

AllEdge imparts the ultimate in contemporary style and finish to lawns and borders. The invertible profile offers the choice of a round or square top edge and completely concealed fixings. AllEdge Premium has flush fitting joints and a choice of length of fixing stakes to suit sub-strate conditions.



### Use it with:

- Fine lawns
- Gravel paths
- Other soft landscape edging

Standard installation method between two soft interfaces such as planting and lawn.

For further technical installation detail go to our website [kinley.co.uk](http://kinley.co.uk)



### Advantages:

- Flexible
- Strong
- Recycled material
- Choice of finishes
- Simple installation
- Reversible design – choose from rounded or square top edge
- Smooth outer face
- Flush fitting joint

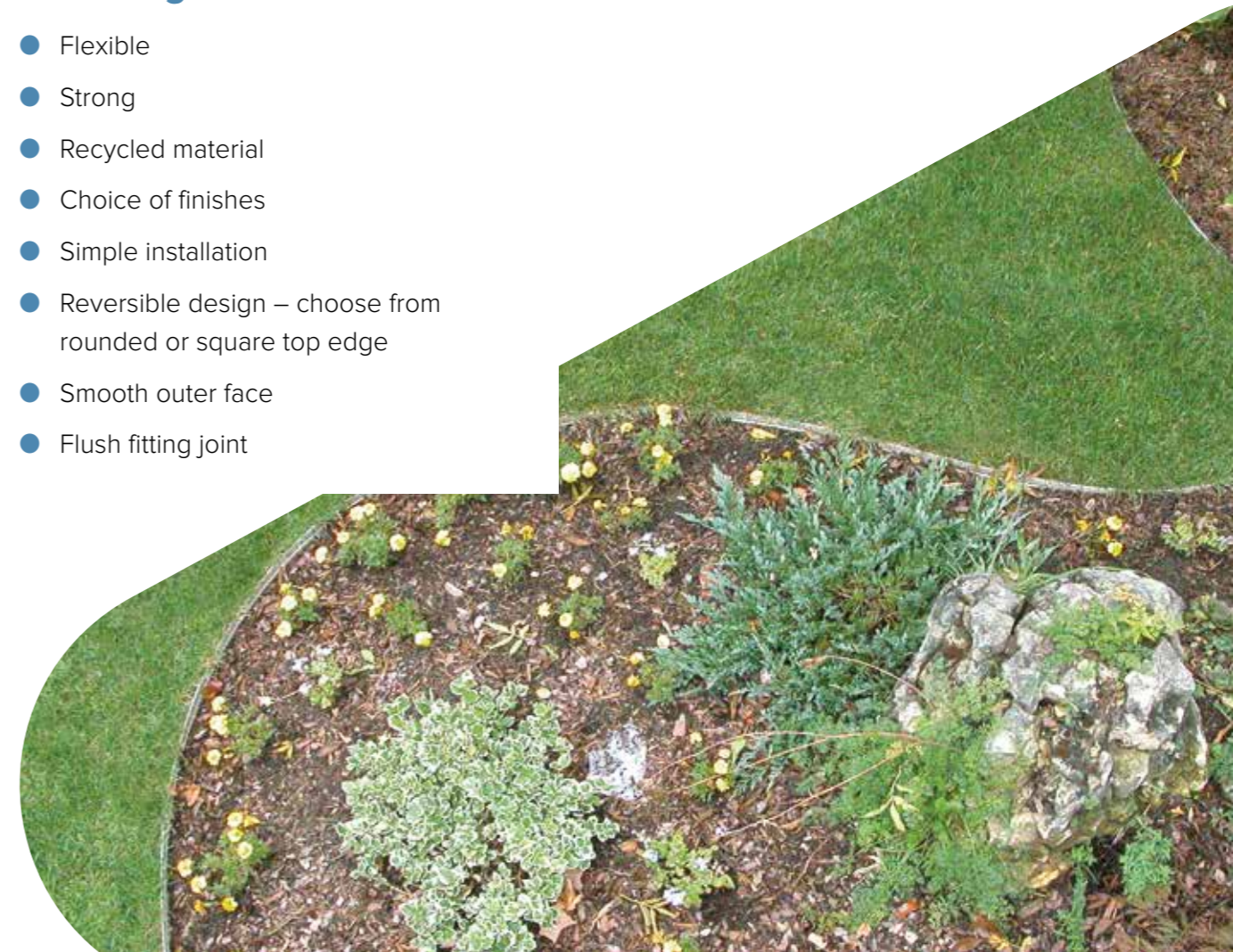



# ExcelEdge AllEdge

Profile height:  
**100 mm**



Made in the UK  
Part recycled  
100% recyclable



## 100 mm profile height

### ALP100M

Premium aluminium lawn edging. Supplied with 3 stakes.

Profile height	<b>100 mm</b>	Weight per length	<b>1.06 kgs</b>
Length	<b>2.5 m</b>	Finish	<b>Mill</b>
Thickness	<b>5 mm</b>		



## Additional Services

### Powder Coating

For that extra special result we can also apply our Armacote™ powder coating to any RAL colour to provide the ultimate outstanding result.



For more information about our project support services please contact our technical team on **+44 (0)1580 830 688** or visit [kinley.co.uk](http://kinley.co.uk)



## Accessories

### ALSTK300

Aluminium fixing stake

Length	<b>300 mm</b>	Colour	<b>Mill</b>
--------	---------------	--------	-------------



### ALSTK450

Aluminium fixing stake

Length	<b>450 mm</b>	Colour	<b>Mill</b>
--------	---------------	--------	-------------



### ALSTK600

Aluminium fixing stake

Length	<b>600 mm</b>	Colour	<b>Mill</b>
--------	---------------	--------	-------------



### ALCS100

Aluminium connector strip

Colour	<b>Mill</b>
--------	-------------



The clearly defined borders are easy to create and make it easier to maintain that perfect finish.

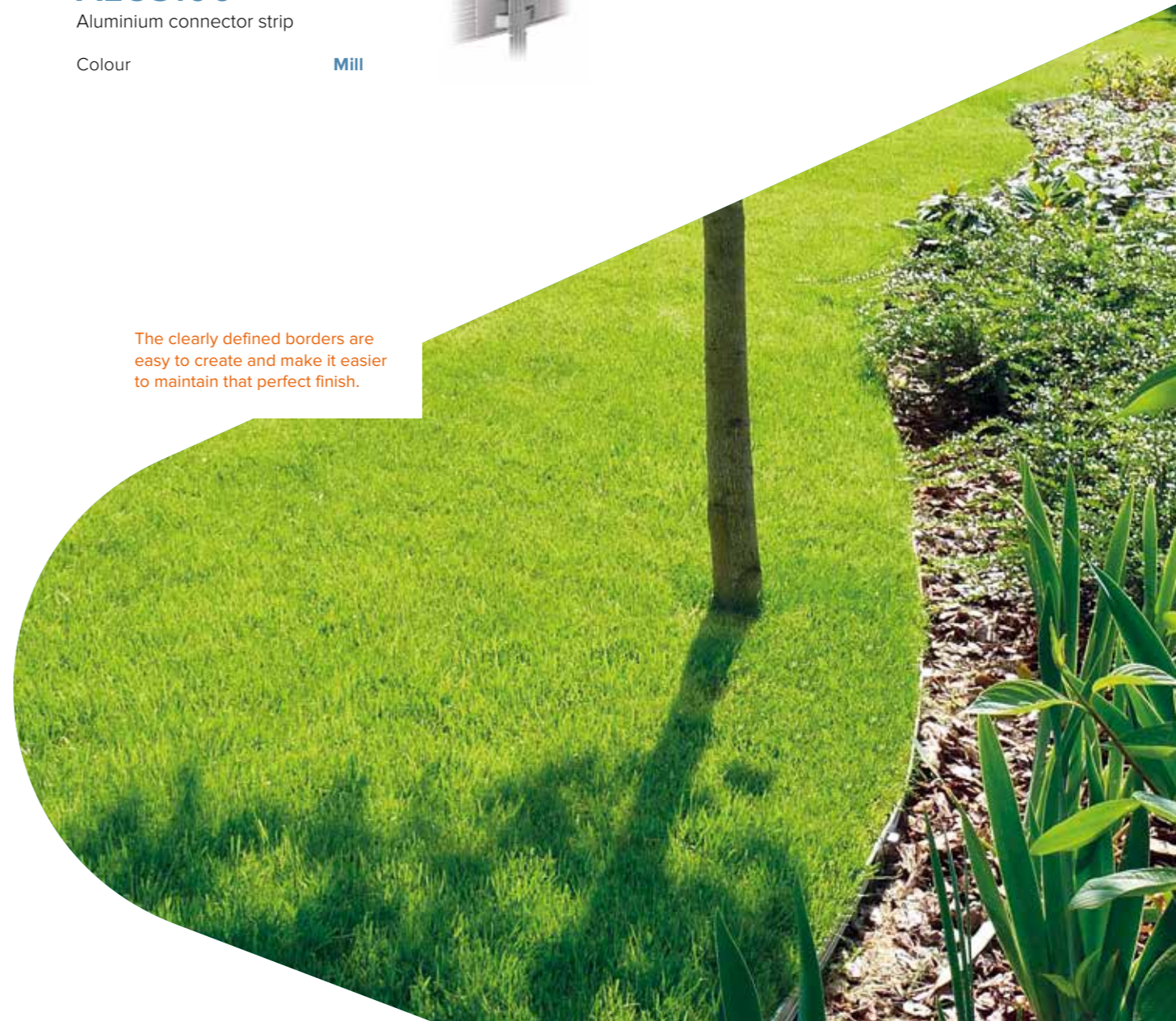

# ExcelEdge RoofEdge

Perforated edging for green roof applications



No longer a novelty, green roof design and construction is presenting landscape professionals with challenging opportunities. Aluminium RoofEdge has vertical perforations ensuring lateral drainage across roof surfaces preventing excessive water accumulation.

### Use it with:

- Intensive Green Roof projects



Standard installation method around the perimeter of an intensive green roof build-up allowing restraint with drainage. No fixing down required, making it quick and easy to use.

For further technical installation detail go to our website [kinley.co.uk](http://kinley.co.uk)



### Advantages:

- Lightweight and robust
- Flexible and versatile
- High quality aluminium alloy
- Vertical slots allow lateral drainage
- Simple and quick to install





## ExcelEdge RoofEdge

Profile heights:  
50 mm - 300 mm



Made in the UK  
100% recycled  
100% recyclable



### 50 mm profile height

#### AR50MR

Aluminium angle **rigid** edge restraint. Supplied with 1 connector strip.

Profile height	<b>50 mm</b>	Thickness	<b>1.5 mm</b>
Length	<b>2.4 m</b>	Top edge bead thickness	<b>5 mm</b>
Horizontal width	<b>100 mm</b>	Finish	<b>Mill</b>



#### AR50MF

Aluminium angle **flexible** edge restraint. Supplied with 1 connector strip.

Profile height	<b>50 mm</b>	Thickness	<b>1.5 mm</b>
Length	<b>2.4 m</b>	Top edge bead thickness	<b>5 mm</b>
Horizontal width	<b>100 mm</b>	Finish	<b>Mill</b>



#### ARC50M

Aluminium angle connector



### 75 mm profile height

#### AR75MR

Aluminium angle **rigid** edge restraint. Supplied with 1 connector strip.

Profile height	<b>75 mm</b>	Thickness	<b>1.5 mm</b>
Length	<b>2.4 m</b>	Top edge bead thickness	<b>5 mm</b>
Horizontal width	<b>100 mm</b>	Finish	<b>Mill</b>



#### AR75MF

Aluminium angle **flexible** edge restraint. Supplied with 1 connector strip.

Profile height	<b>75 mm</b>	Thickness	<b>1.5 mm</b>
Length	<b>2.4 m</b>	Top edge bead thickness	<b>5 mm</b>
Horizontal width	<b>100 mm</b>	Finish	<b>Mill</b>



#### ARC75M

Aluminium angle connector

Length **250 mm**



### 100 mm profile height

#### AR100MR

Aluminium angle **rigid** edge restraint. Supplied with 1 connector strip.

Profile height	<b>100 mm</b>	Thickness	<b>1.5 mm</b>
Length	<b>2.4 m</b>	Top edge bead thickness	<b>5 mm</b>
Horizontal width	<b>100 mm</b>	Finish	<b>Mill</b>



#### AR100MF

Aluminium angle **flexible** edge restraint. Supplied with 1 connector strip.

Profile height	<b>100 mm</b>	Thickness	<b>1.5 mm</b>
Length	<b>2.4 m</b>	Top edge bead thickness	<b>5 mm</b>
Horizontal width	<b>100 mm</b>	Finish	<b>Mill</b>



#### ARC100M

Aluminium angle connector

Length **250 mm**

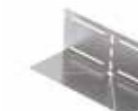



### 150 mm profile height

#### AR150MR

Aluminium angle **rigid** edge restraint. Supplied with 1 connector strip.

Profile height	<b>150 mm</b>	Thickness	<b>1.5 mm</b>
Length	<b>2.4 m</b>	Top edge bead thickness	<b>5 mm</b>
Horizontal width	<b>150 mm</b>	Finish	<b>Mill</b>



#### AR150MF

Aluminium angle **flexible** edge restraint. Supplied with 1 connector strip.

Profile height	<b>150 mm</b>	Thickness	<b>1.5 mm</b>
Length	<b>2.4 m</b>	Top edge bead thickness	<b>5 mm</b>
Horizontal width	<b>150 mm</b>	Finish	<b>Mill</b>



#### ARC150M

Aluminium angle connector

Length	<b>250 mm</b>
--------	---------------



### 200 mm profile height

#### AR200MR

Aluminium angle **rigid** edge restraint. Supplied with 1 connector strip.

Profile height	<b>200 mm</b>	Thickness	<b>1.5 mm</b>
Length	<b>2.4 m</b>	Top edge bead thickness	<b>5 mm</b>
Horizontal width	<b>150 mm</b>	Finish	<b>Mill</b>



#### AR200MF

Aluminium angle **flexible** edge restraint. Supplied with 1 connector strip.

Profile height	<b>200 mm</b>	Thickness	<b>1.5 mm</b>
Length	<b>2.4 m</b>	Top edge bead thickness	<b>5 mm</b>
Horizontal width	<b>150 mm</b>	Finish	<b>Mill</b>



#### ARC200M

Aluminium angle connector

Length	<b>250 mm</b>
--------	---------------



### 300 mm profile height

#### AR300MR

Aluminium angle **rigid** edge restraint. Supplied with 1 connector strip.

Profile height	<b>300 mm</b>	Thickness	<b>1.5 mm</b>
Length	<b>2.4 m</b>	Top edge bead thickness	<b>5 mm</b>
Horizontal width	<b>200 mm</b>	Finish	<b>Mill</b>



#### AR300MF

Aluminium angle **flexible** edge restraint. Supplied with 1 connector strip.

Profile height	<b>150 mm</b>	Thickness	<b>1.5 mm</b>
Length	<b>2.4 m</b>	Top edge bead thickness	<b>5 mm</b>
Horizontal width	<b>150 mm</b>	Finish	<b>Mill</b>



#### ARC300M

Aluminium angle connector

Length	<b>250 mm</b>
--------	---------------



The vertical perforations allow for water drainage whilst restraining the green roof material

# ExcelEdge RoofEdge Premium

Premium edging for green roof applications

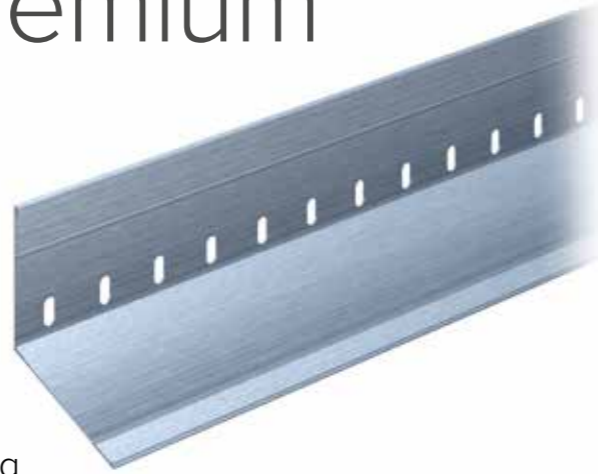

No longer a novelty, green roof design and construction is presenting landscape professionals with challenging opportunities. Aluminium RoofEdge Premium has vertical perforations ensuring lateral drainage across roof surfaces preventing excessive water accumulation.

### Use it with:

- Green Roof projects
- External terraces



# ExcelEdge RoofEdge Premium

Premium edging for green roof applications



Made in the UK  
Part recycled  
100% recyclable



100 mm profile height

## ARP100RM

Aluminium angle **rigid** edge restraint. Supplied with 1 connector strip.

Profile height:	<b>100mm</b>	Thickness:	<b>1.6 mm</b>
Length:	<b>2.4m</b>	Top edge bead thickness:	<b>6 mm</b>
Horizontal width:	<b>150 mm</b>	Finish:	<b>Mill</b>



### Advantages:

- Lightweight and robust
- Strong aluminum extrusion profile
- Square top edge design
- High quality aluminium alloy
- Vertical slots allow lateral drainage
- Simple and quick to install





# Steel edging

**ExcelEdge**  
**Borderline**  
 Steel lawn edging

34

42

**Perimeta**  
**HiGrade**  
**Bespoke**  
 Bespoke 6 mm pre-formed  
 steel panel system

**ExcelEdge**  
**HiGrade**  
 Heavy duty steel  
 landscape edging

38

46

**ExcelEdge**  
**Contour**  
 Heavy duty steel  
 angle edging

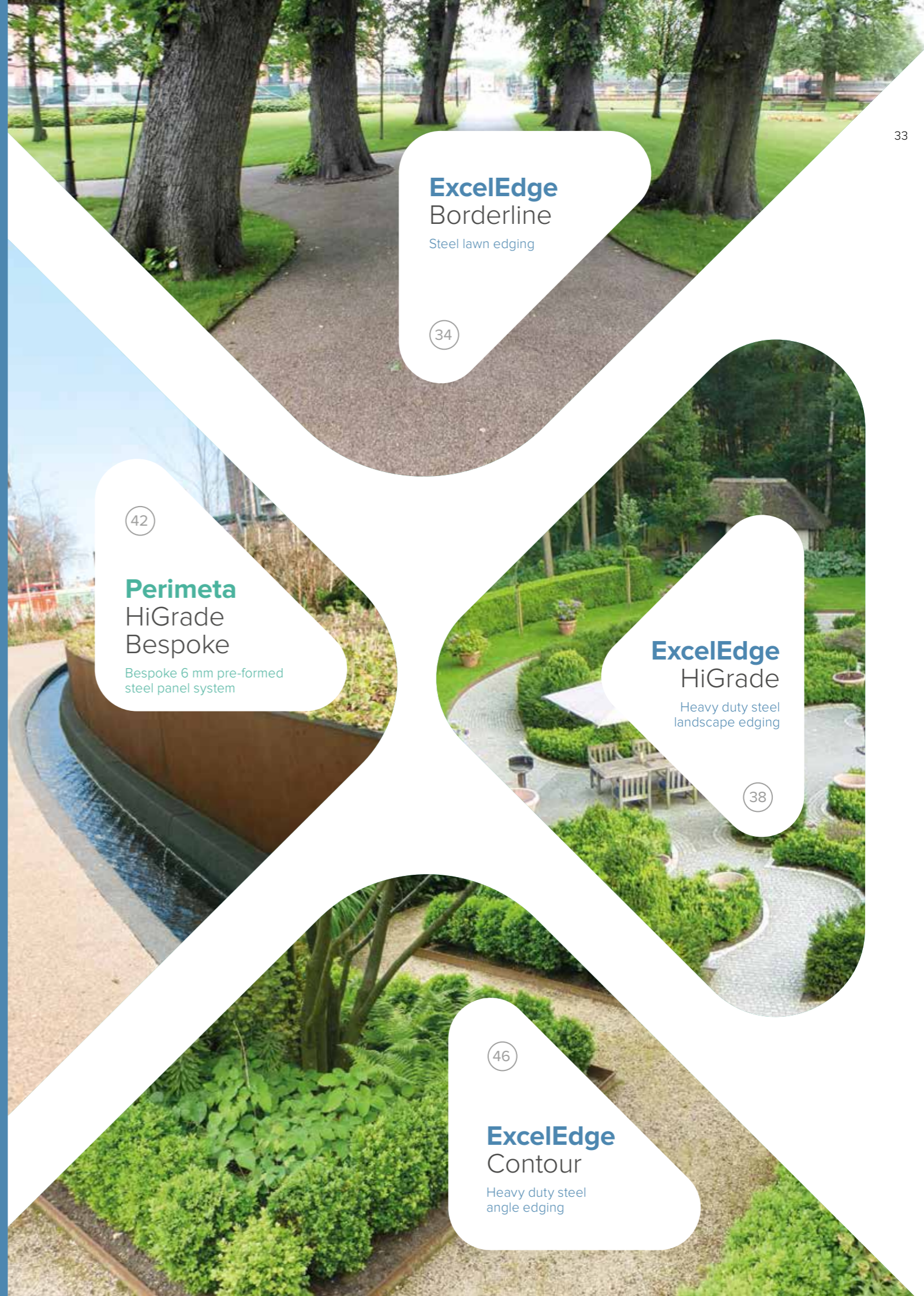

# ExcelEdge Borderline

Steel lawn edging



The steel edging for Public Realm and other heavy-traffic landscaping projects. The benefits and simplicity of the unique Borderline overlapping joining and fixing system have drawn plaudits from many landscape professionals. It provides very strong and almost invisible connections between sections. It is also much quicker and easier than rival products to install, in rigid or curved boundary lines.

### Use it for:

- Traditional lawns
- Kitchen gardens
- Gravel paths & drives
- Contemporary gardens



Standard installation method between two soft interfaces such as lawn and planting beds the Borderline creates a stable edge to keep a neat defined border.

For further technical installation detail go to our website [kinley.co.uk](http://kinley.co.uk)



### Advantages:

- Save hours of backbreaking edge maintenance work
- Flexible and hard-wearing
- Powder coated finish designed to withstand the elements
- Thickness of 2 mm or 3 mm
- Heavy duty 5 mm version available
- Standard depths of 100 mm and 150 mm
- Available in brown, galvanised or untreated mild steel finish





# ExcelEdge Borderline

Profile heights:  
100 mm - 150 mm

Thickness:  
2 mm - 5 mm



Made in the UK  
100% recycled  
100% recyclable



## 100 mm profile height

### 2 mm thickness

Steel lawn edging

Profile height	<b>100 mm</b>	Weight per length	<b>3.04 kgs</b>
Length	<b>2.0 m</b>	Fixings	<b>3no. Flat stake x 305 mm</b>
Thickness	<b>2 mm</b>		

#### BL20BR

Finish **Powder coated brown**



### 3 mm thickness

Steel lawn edging

Profile height	<b>100 mm</b>	Weight per length	<b>4.10 kgs</b>
Length	<b>2.0 m</b>	Fixings	<b>3no. Flat stake x 305 mm</b>
Thickness	<b>3 mm</b>		

#### BL30BR

Finish **Powder coated brown**



#### BL30G

Finish **Galvanised**



#### BL30U

Finish **Untreated steel**



## 150 mm profile height

### 3 mm thickness

Steel lawn edging

Profile height	<b>150 mm</b>	Weight per length	<b>6.76 kgs</b>
Length	<b>2.0 m</b>	Fixings	<b>3no. Flat stake x 410 mm</b>
Thickness	<b>3 mm</b>		

#### BL150BR

Finish **Powder coated brown**



#### BL150G

Finish **Galvanised**



#### BL150U

Finish **Untreated steel**



### 5 mm thickness

Jumbo steel lawn edging

Profile height	<b>150 mm</b>	Weight per length	<b>11.38 kgs</b>
Length	<b>2.0 m</b>	Fixings	<b>3no. Flat stake x 410 mm</b>
Thickness	<b>5 mm</b>		

#### BL150J5U

Finish **Untreated steel**



# ExcelEdge HiGrade

Heavy duty steel landscape edging

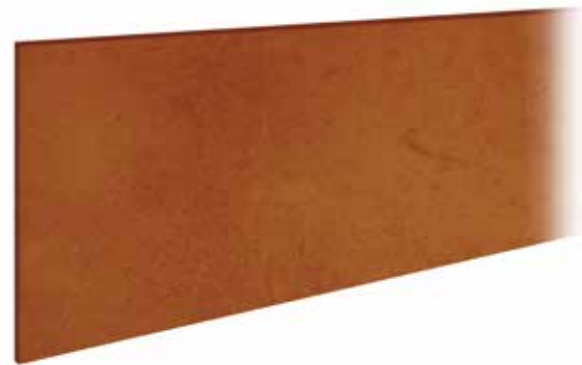

Steel edgings for prestigious projects requiring maximum strength and durability. This is the ultimate edging in strength and durability with thicknesses up to 8 mm.



### Use it for:

- Lawn edging
- Paths/Drive edging
- Total landscape set out

HiGrade comes with five 450 mm fixing pins and provides a very secure installation. When in high traffic public realm areas or when it is used in vehicular zones then a concrete haunch may be needed.

For further technical installation detail go to our website [kinley.co.uk](http://kinley.co.uk)



### Advantages:

- Strong and robust
- Wide range of sizes and finishes – including CorTen steel.
- Flexible
- Bespoke design & support



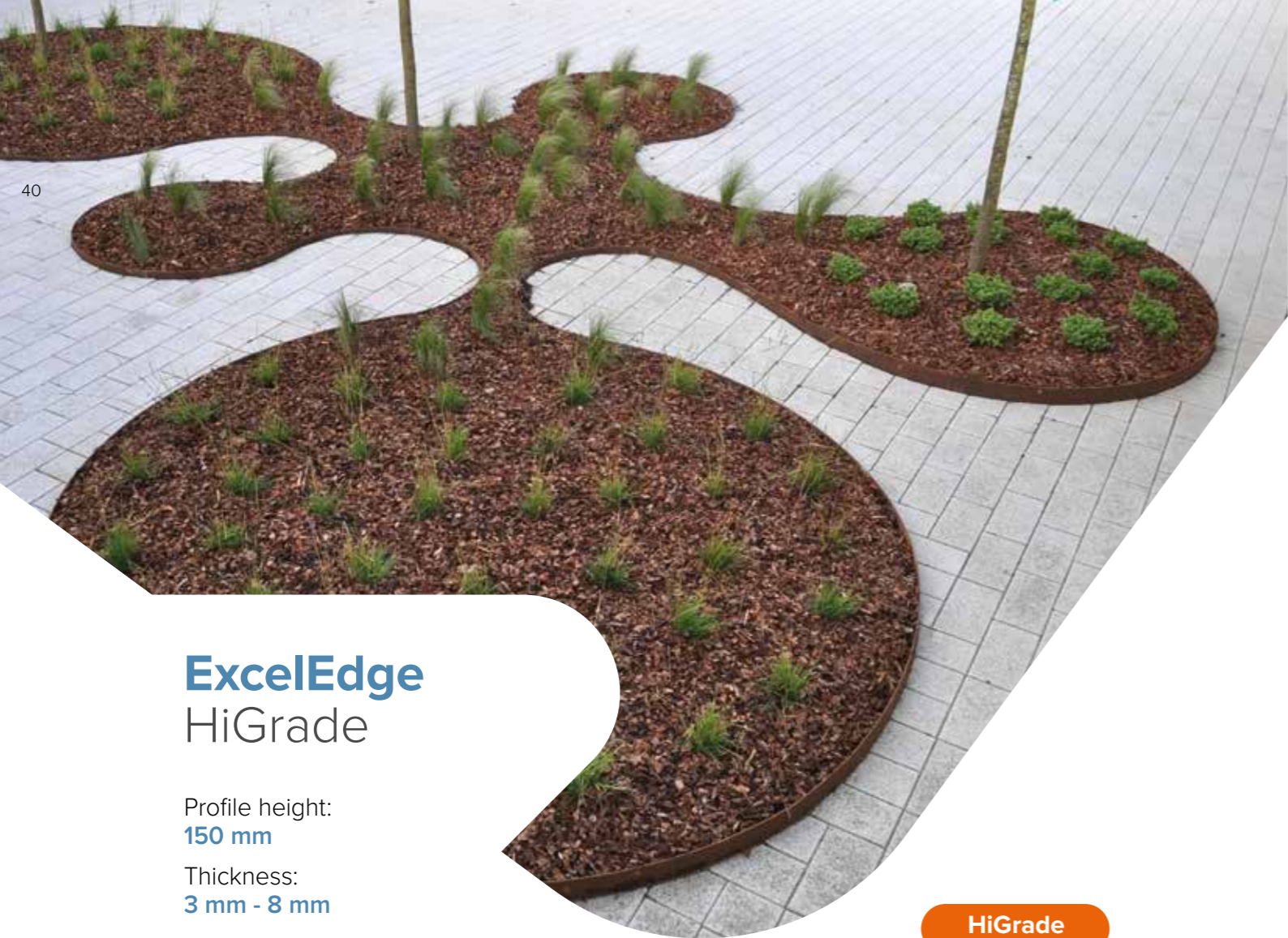

## ExcelEdge HiGrade

Profile height:  
**150 mm**

Thickness:  
**3 mm - 8 mm**



**HiGrade**  
Case study  
Page 54



**150 mm profile height**

### 3 mm thickness

HiGrade steel edge restraint. Supplied with 5 fixing stakes and 2 strip connectors.

Profile height	<b>150 mm</b>	Weight per length	<b>3.3 kgs</b>
Length	<b>3.0 m</b>	Stakes per length	<b>5</b>
Thickness	<b>3 mm</b>		



**HG3C** Finish **CorTen** **HG3G** Finish **Galvanised** **HG3S** Finish **Stainless Steel** **HG3U** Finish **Untreated steel**

### 6 mm thickness

HiGrade steel edge restraint. Supplied with 5 fixing stakes and 2 strip connectors.

Profile height	<b>150 mm</b>	Weight per length	<b>7.3 kgs</b>
Length	<b>3.0 m</b>	Stakes per length	<b>5</b>
Thickness	<b>6 mm</b>		



**HG6C** Finish **CorTen** **HG6G** Finish **Galvanised** **HG6S** Finish **Stainless Steel** **HG6U** Finish **Untreated steel**

### 8 mm Thickness

HiGrade steel edge restraint. Supplied with 5 fixing stakes and 2 strip connectors.

Profile height	<b>150 mm</b>	Weight per length	<b>10.3 kgs</b>
Length	<b>3.0 m</b>	Stakes per length	<b>5</b>
Thickness	<b>8 mm</b>		



**HG8C** Finish **CorTen** **HG8G** Finish **Galvanised** **HG8S** Finish **Stainless Steel** **HG8U** Finish **Untreated steel**

In addition to the wide range of stock sizes available is the capability for custom made steel edgings. Call our team to discuss your project and discover how HiGrade can deliver the ultimate steel edging solution.

## Additional Services

### Bespoke Fabrication

Where circles or symmetrical curved shapes are required we recommend utilising our pre-forming service to ensure an accurate result.

### Powder Coating

For that extra special result we can also apply our Armacote™ powder coating to any RAL colour to provide the ultimate outstanding result.

For more information about our project support services please contact our technical team on **+44 (0)1580 830 688** or visit **kinley.co.uk**



# Perimeta HiGrade Bespoke

Bespoke 6 mm pre-formed steel panel system

Bespoke steel edgings for prestigious projects requiring maximum strength and durability. The HiGrade Bespoke 6 mm system is the ultimate option for creating a retaining wall structure to almost any design. This system can be formed to curved or straight designs and reduce or increase in height throughout the length.



Example layout only

### Use it for:

- Bespoke shaped planters
- Landscape retaining walls
- Podium or terrace planting areas

### Advantages:

- High quality panel system available in bespoke sizes
- Can be pre-formed to curved or straight designs
- Available in CorTen or powder coated finishes
- Simple to assemble on site
- Supplied with triangular support brackets and hidden connections





## Perimeta HiGrade Bespoke

Bespoke 6 mm  
pre-formed steel  
panel system



### How it works:

- Step 1.** Design your inspired place
- Step 2.** Send your concept plan to Kinley or request a consultation
- Step 3.** Kinley advise on how to make it possible
- Step 4.** Kinley provide detail costing
- Step 5.** Your design is supplied in preformed sections to site.  
Site support is available if required.
- Step 6.** Enjoy your inspired place made possible by Kinley!

Book a consultation to discuss your requirements today. Call **+44 (0)1580 830 688** or go to the consultation page on our website [kinley.co.uk](http://kinley.co.uk)

### Design parameters:

- Individual sections up to 3 m long
- Height range is from 300 mm - 1500 mm
- Height can be consistent or varied but the bottom edge must always sit level (this will mean a stepped Foundation if going up a slope)
- A range of finishes
- Endless opportunities for shapes!

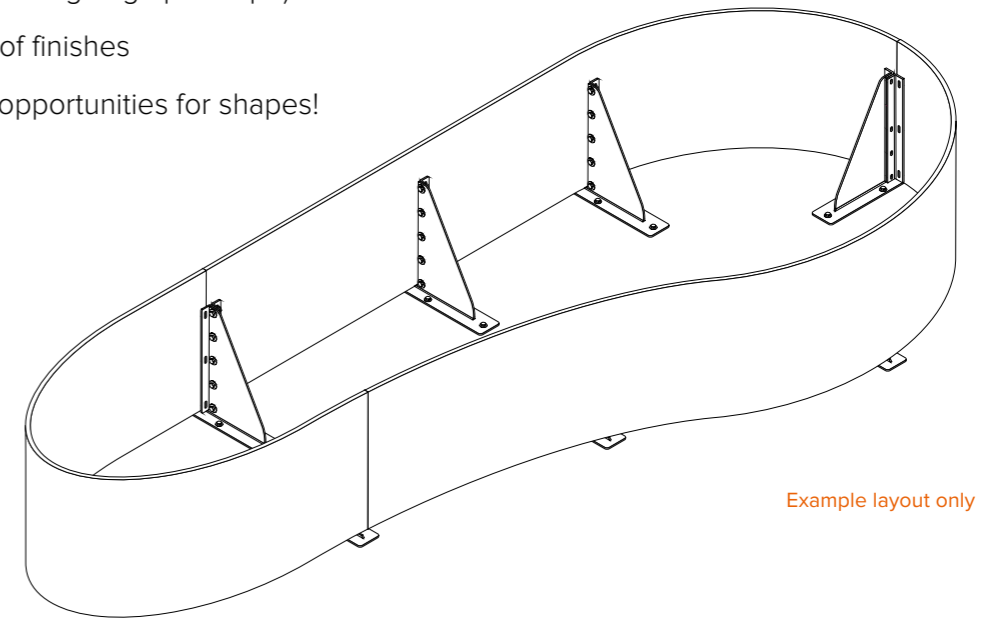

Example layout only

CAD drawings and  
technical support  
available



### Finishes:

- Galvanised
- CorTen (supplied to site unweathered)
- Ready-to-paint
- Armacote™ powder coating to any RAL colour
- For special requests contact our technical team to see if it is available

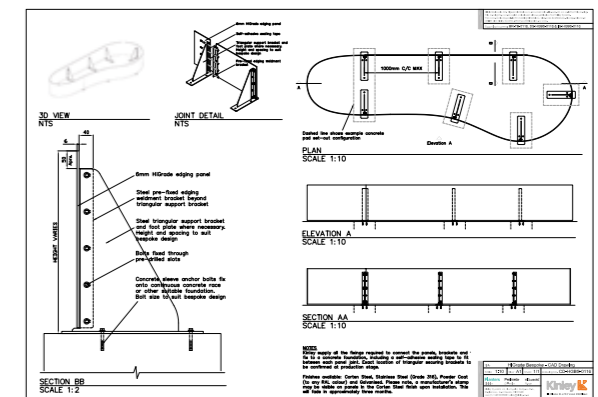

# ExcelEdge Contour

Heavy duty steel angle edging

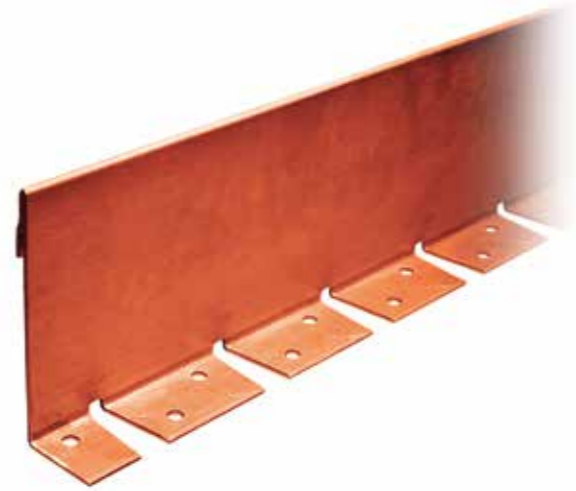

The heavy duty roll topped steel edging for Parks, Public Realm and Building Perimeters. Available in flexible or rigid format, 150 mm profile height, in galvanised or CorTen steel, Contour is the edging of choice for demanding, heavy traffic locations. Its stability relies on securing it to a compacted substrate (e.g. MOT Type 1) with 250 mm steel spiral fixing stakes.



### Use it with:

- Lawn edging
- Paths/Drive edging

In parks, public realm and around building perimeters it copes with the edging demands or demarcation of asphalt, rubber coating or other hard landscape surfaces.

For further technical installation detail go to our website [kinley.co.uk](http://kinley.co.uk)



### Advantages:

- Strong and robust
- Rolled top – no sharp edge
- Flexible
- Bespoke design & support
- Fast simple installation
- Available in CorTen or galvanised steel







## ExcelEdge Contour

Profile height:  
**150 mm**  
Thickness:  
**3 mm and 6 mm**



150 mm profile height

### 3 mm thickness

**Rigid** Heavy duty steel edge restraint

Profile height	<b>150 mm</b>	Weight per length	<b>7.5 kgs</b>
Length	<b>2.5 m</b>	Fixings	<b>7no. Spiral spikes x 250 mm</b>
Steel thickness	<b>1.5 mm</b>		
Top edge thickness	<b>3 mm</b>		

**CO3RC**



Finish

**CorTen**

**CO3RG**



Finish

**Galvanised**

### 3 mm thickness

**Flexible** Heavy duty steel edge restraint

**CO3FC**



Finish

**CorTen**

**CO3FG**

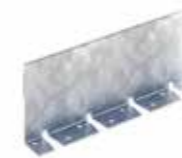

Finish

**Galvanised**



150 mm profile height

### 6 mm thickness

**Rigid** edge restraint in heavy duty steel

Profile height	<b>150 mm</b>	Weight per length	<b>13 kgs</b>
Length	<b>2.5 m</b>	Fixings	<b>7no. Spiral spikes x 250 mm</b>
Steel thickness	<b>3 mm</b>		
Top edge thickness	<b>6 mm</b>		

**CO6RC**



Finish

**CorTen**

**CO6RG**



Finish

**Galvanised**

### 6 mm thickness

**Flexible** edge restraint in heavy duty steel

**CO6FC**



Finish

**CorTen**

**CO6FG**

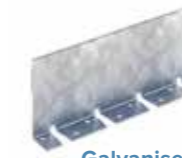

Finish

**Galvanised**

Book your free lunch-time CPD presentation or download the technical drawings by going to the resource centre on our website [kinley.co.uk](http://kinley.co.uk)

# Gravel stabilisation panels

## Gravelrings

Gravel stabilisation panels



The intelligent design utilises a containment cell system together with an open mesh base which not only allows the free draining of water but also prevents the build up of silt and fine debris within the gravel containment cell.

Loose aggregate surfacing is a highly popular and cost effective method of creating an attractive hard landscape finish to paths, driveways and parking areas.

The porous nature of loose aggregate or "gravel" makes a valuable contribution to a SUDS scheme as well as being lower cost than bound gravels or other

porous hard landscape surfaces. The issues with loose gravels are well known: gravel migration and rutting, difficulty in walking, cycling, or pushing small wheeled vehicles have all been key challenges for using gravel in many locations.

Using loose aggregate within a stabilisation panel makes a highly cost effective hard landscape surface

### Use it with:

- Paths
- Driveways
- Car parks
- Cycle paths



# Gravelrings

## Gravel stabilisation panels

that is aesthetically pleasing, very fast to install and easy to maintain. The stabilised gravel creates a surface over which it is easy to walk, cycle, or push small-wheeled equipment such as wheel-chairs or lawn mowers.

Even with a traditional compacted sub base (typically MOT Type 1), Stabilised Gravel Surfacing creates a free-draining permeable paving layer which, other

than in the most extreme rainfall conditions, eliminates water run-off from the paved surface. This is a major contributor to reducing demand on surface water drainage capacity. The system can also be used as part of a fully permeable hard landscape construction, establishing a stable top surface, over a purpose-designed permeable drainage layer, or water harvesting installation.

## AluExcel installation with Gravelrings

One common application for the AluExcel is as an edging restraint for an area with cellular gravel containment systems such as our Gravelrings stabilisation panels. Gravel is spread over the panels allowing 10-15 mm coverage over the top edge to completely conceal the rings, flush with the top edge of the AluExcel 40 mm edging.

For further technical installation detail go to our website [kinley.co.uk](http://kinley.co.uk)

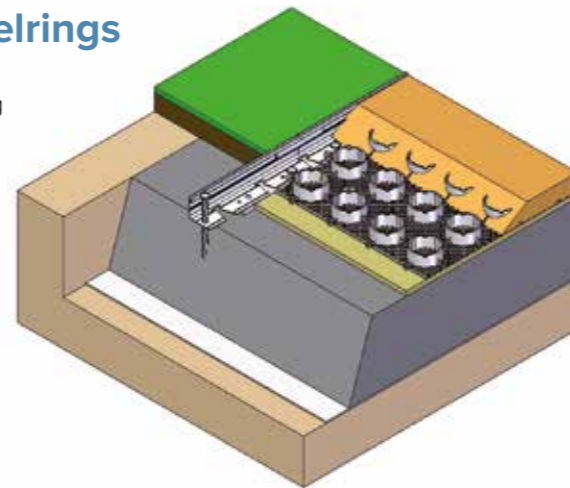

### Advantages:

- Fully permeable hard landscape layer
- Effectively contained and stabilised gravel surface
- No sinking, rutting or gravel migration
- Excellent load bearing capacity suitable for pedestrian and vehicular traffic



## Technical Data

### Translucent white: GR25T Black: GR25B



Application:	<b>Pedestrian and vehicular traffic</b>
Panel Size:	<b>500 x 500 mm – assembled and delivered in 1 m<sup>2</sup> panels</b>
Panel depth:	<b>25 mm</b>
Gravel demand:	<b>45 - 50 kgs per square metre</b>
Weight bearing capacity:	<b>&gt;350 tonnes per square metre</b>
Containment cell diameter:	<b>25 mm</b>
Material thickness/ weight:	<b>2 mm / 2.24 kg/sqm</b>
Recommended gravel size:	<b>6 mm - 20 mm</b>
Drainage Capacity SUDS compliance:	<b>Fully permeable</b>
Raw material:	<b>100% UK made recycled HDPE – fully UV stabilised</b>
Colour:	<b>Semi-translucent white or solid black</b>
Chemical resistance:	<b>Resistant to most chemicals and environmental aggression</b>
Design Protection:	<b>OHIM Registered Design EU (Certificate No. 001928888-0001)</b>

- Fast and easy to install
- Weed resistant low maintenance surface
- Invisible once installation is complete
- Lightweight
- Recycled and recyclable material
- Easily cut to shape
- Versatile panel size and configuration



# Case Studies

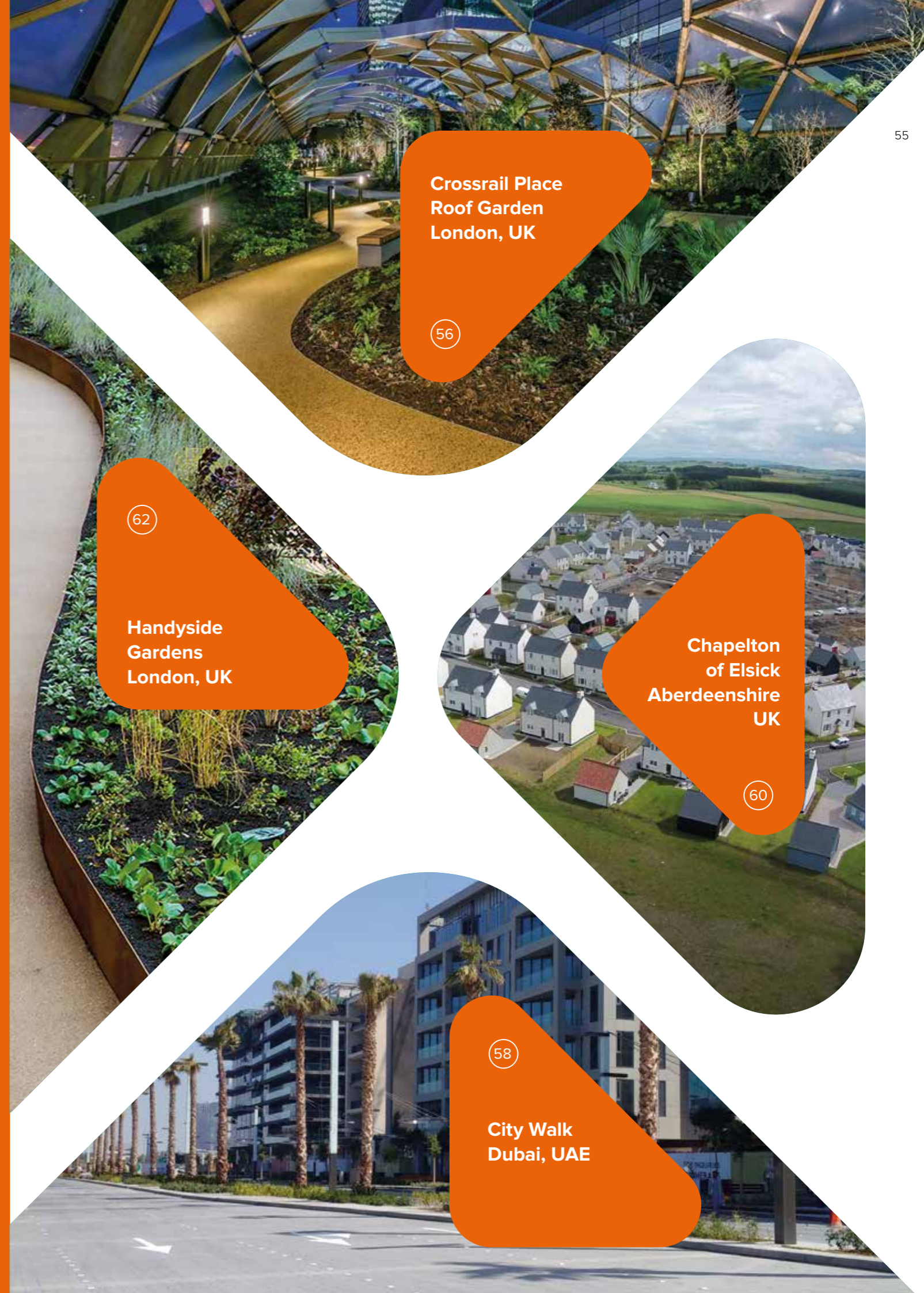

**Crossrail Place  
Roof Garden  
London, UK**

56

**Handyside  
Gardens  
London, UK**

62

**Chapelton  
of Elsick  
Aberdeenshire  
UK**

60

**City Walk  
Dubai, UAE**

58



## Crossrail Place Roof Garden London, UK



Flexible edging creates winding paths at tropical roof garden in £500 million Canary Wharf project.

Canary Wharf is home to London's largest Crossrail station. At 115,000 sq ft, the six storey complex partially extends below water level at the West India Quay and houses one of the largest rooftop gardens in the capital.

Foster + Partners designed the roof structure and cladding that houses the station's leisure complex. Beneath the 310-metre hood style roof is a garden, featuring a number of exotic plants. Gillespies, which previously designed the sloping garden at 20 Fenchurch Street, was chosen to lead the project.

- Architect:** Foster + Partners
- Landscape Architect:** Gillespies
- Contractor:** Blakedown Landscapes
- Application:** AluExcel edging between resin bound hard surface areas and plant beds

Featured in the plans were several curved paths designed to lead visitors around the garden. This meant that edging was required that would be strong enough to withstand increasing amounts of pedestrian traffic but also flexible enough to fit the curved design.

As a lightweight aluminium, AluExcel is significantly stronger than other edging materials. Traditional edging typically uses bulky concrete pin kerbs which waste valuable space due to their size and the fact that they have to be bedded and supported with concrete. The pin kerbs are also much heavier; one person can lift only one metre. In comparison, 25 metres of AluExcel can be lifted at once, making it an ideal solution for architects and contractors.

To find out more, see the full case study in the **Resource Centre** on our website [kinley.co.uk](http://kinley.co.uk)

**Products used to make this project possible:**

**ExcelEdge** AluExcel  
Aluminium angle edging



For AluExcel product details see page 10





## City Walk Dubai, UAE



Rigid aluminium edging used to preserve and emphasise the crisp, straight paths featured in this extensive project.

City Walk is an urban living concept developed by Meeras Holding, situated in Dubai. It is a stunning outdoor destination that offers visitors a unique mix of retail and gourmet outlets. The first phase, with 52 outlets, 350 metres of uninterrupted retail frontage and 600 parking spaces was opened in 2013. Phases 2 and 3, themselves subdivided and under construction will more than double the total amenity.

Flanked by a grand tree-lined walk evocative of European streets plus a unique lake and water feature, the venue hosts intimate concerts, weekly

- Architect:** Place Dynamix
- Contractor:** Dutco Balfour Beatty
- Application:** AluExcel defines pathways at stunning outdoor destination

markets and exhibitions which enhance the overall appeal of the outdoor lifestyle concept. With splendid views of the Burj Khalifa in the background, City Walk offers a sensational shopping and dining environment.

To preserve and emphasise the crisp straight lines which are a feature of the extensive and attractive landscaping, rigid AluExcel aluminium edging was specified due to its superior appearance and whole-life costing in comparison to more traditional products.

City Walk's unique concept and dynamic mix of retail outlets is certain to appeal to residents and tourists alike. The project aims to be a major attraction for visitors from other parts of the UAE and the wider region.

To find out more, see the full case study in the **Resource Centre** on our website [kinley.co.uk](http://kinley.co.uk)



### Products used to make this project possible:

**ExcelEdge** AluExcel  
Aluminium angle edging



For AluExcel product details see page 10





## Chapelton of Elsick Aberdeenshire UK



AluExcel supports footpaths forming part of new pedestrian-scaled neighbourhoods just south of Aberdeen.

Chapelton of Elsick is a visionary development near Aberdeen. Led by Elsick Development Company and designed by renowned architects, Duany Plater-Zyberk, the £2billion scheme includes plans for over 8,000 homes, space for leisure and business facilities, schools and parks.

Benton Scott-Simmons wanted to avoid using straight lengths of concrete kerbing on the numerous Chapelton footpaths as it results in a faceted edge. Instead, AluExcel was selected because it allowed the architects to incorporate more diverse

- Architect:** Duany Plater-Zyberk (DPZ)
- Landscape Architect:** Benton Scott-Simmons
- Contractor:** W M Donald
- Application:** Edging between asphalt paths and grass verges to create footpaths

geometries as the material could be supplied pre-formed to specific radii or manipulated on site where necessary.

During the installation of AluExcel, Kinley worked closely with W M Donald to ensure it was a success. Once a method of working was devised that took account of the construction sequence on site, the organic shapes on the grass verges, a characteristic of the Chapelton masterplan, were achieved.

Due to the scope and scale of the development, it was vital that Kinley remained involved throughout the entire project. From assisting with obtaining approvals from Aberdeenshire Council, to providing on-site support, Kinley played a central role in ensuring the use of AluExcel edging was a success. It is hoped that this project will set a precedent and highlight the benefits of large-scale use of flexible aluminium edging.

To find out more, see the full case study in the **Resource Centre** on our website [kinley.co.uk](http://kinley.co.uk)

### Products used to make this project possible:

#### ExcelEdge AluExcel Aluminium angle edging



For AluExcel product details see page 10





## Handyside Gardens London, UK



Raised planters feature in design of new public park influenced by the area's railway heritage.

King's Cross is one of the biggest and most exciting areas to be redeveloped in London. 67 acres of unused wasteland is being transformed into a brand new community, complete with its own postcode. The project includes 50 new buildings, 1,900 homes and numerous leisure, business and education facilities.

Handyside Gardens is a beautiful pocket of land with stunning landscapes, minutes from Granary Square and Regent's Canal. Influenced by its railway surroundings, large planters have been incorporated into the design containing greenery that is typically

**Landscape Architect:** Townshend Landscape Architects  
**Contractor:** Maylim Ltd  
**Application:** HiGrade Bespoke Planter System features in innovative urban development

found growing on railway embankments. HiGrade Bespoke Planters made from COR-TEN steel, a material used in the construction of railways in the industrial age, were installed in the park to create eye catching raised beds.

Due to the large numbers of people expected to visit the park daily, safety was paramount. King's Cross Central General Partner specified that, in order to limit the risk of accidents occurring in the park, the top edge of the raised planters needed to be 50mm thick. This meant that the top capping had to be welded onto the planters on-site due to their varying sizes and curved shapes. Although this meant the installation process was much more labour intensive, it created an attractive end result.

To find out more, see the full case study in the **Resource Centre** on our website [kinley.co.uk](http://kinley.co.uk)



**Product used to make this project possible:**

**Perimeta** HiGrade Bespoke  
Bespoke 6 mm pre-formed steel panel system



For HiGrade Bespoke product details see page 42





# How we can help you achieve.

## Book a CPD

We're here to help you create amazing spaces for people to enjoy. That's why at Kinley we offer training and support, covering all our products so you can get the most out of your project. We regard effective training as key to successful specification and installation of our products and we offer a range of training seminars to landscape architects and designers.

## Visit the resource centre

An invaluable bank of information to make design and specification as simple and fast as possible.

The resource centre includes:

- Technical CAD drawings
- Data sheets
- Installation guides
- Case studies
- Image gallery
- Videos

go to [www.kinley.co.uk/resource-centre](http://www.kinley.co.uk/resource-centre)

## Contact our technical team

For further information or to discuss your designs give us a call on **+44 (0)1580 830688** or email [sales@kinley.co.uk](mailto:sales@kinley.co.uk) to discover how we can make your inspired places possible!

# Our ranges

The Kinley edging is just part of our product portfolio which is as a result of our extensive experience of the landscape and terrace sector. It is based on a strong commitment to research and development and addresses the requirements of architects, installers and clients. Adding a steel planter to any external environment gives it a signature of style and creates the perfect finish to any amazing space. Porcelain tiles are the ultimate surfaces when it comes to external terrace areas as they are extremely durable and we have a palate of beautiful finishes. Ideal for balconies, roof terraces and any elegant external design the composite decking is both contemporary and is virtually maintenance free. Our support structures answer the questions to many issues that arise when installing a terrace or podium design with build-up issues or just making it a whole lot more simple to install multiple surfaces on one level with a void beneath.

To find out more about our product ranges to suit the external terrace environment request the Kinley Terrace Book to see the complete package.



For more information about our other products and brands please contact our sales team

t: +44 (0)1580 830 688  
e: sales@kinley.co.uk

[kinley.co.uk](http://kinley.co.uk)

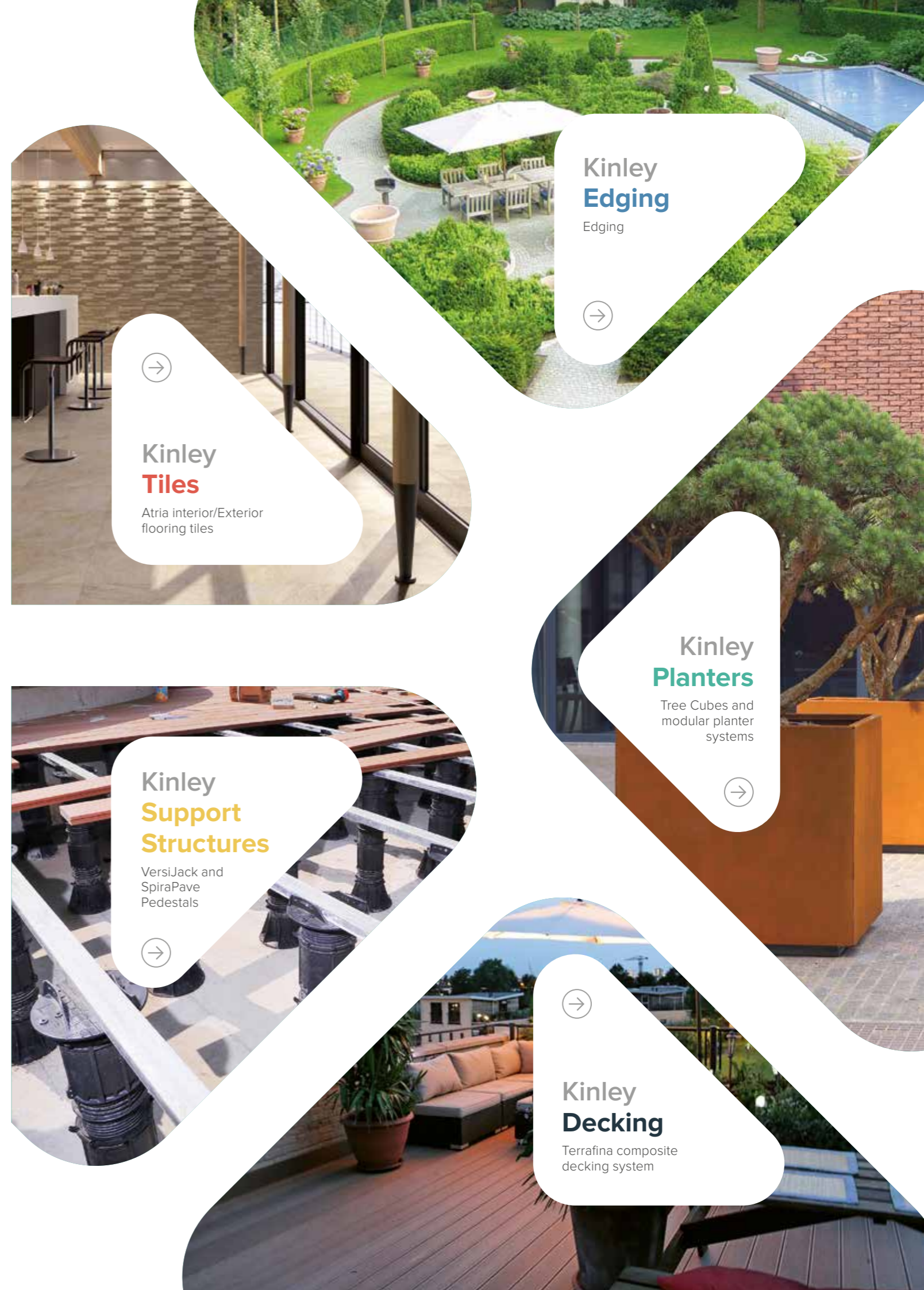

**Kinley Edging**  
Edging

→

→

**Kinley Tiles**  
Atria interior/Exterior flooring tiles

**Kinley Planters**  
Tree Cubes and modular planter systems

→

**Kinley Support Structures**  
VersiJack and SpiraPave Pedestals

→

→

**Kinley Decking**  
Terrafina composite decking system

INSPIRED PLACES MADE POSSIBLE

**Kinley**

Northpoint, Compass Park  
Staplecross, East Sussex  
TN32 5BS United Kingdom

t: **+44 (0)1580 830688**

e: **sales@kinley.co.uk**

**kinley.co.uk**

**Kinley** 

INSPIRED PLACES MADE POSSIBLE