

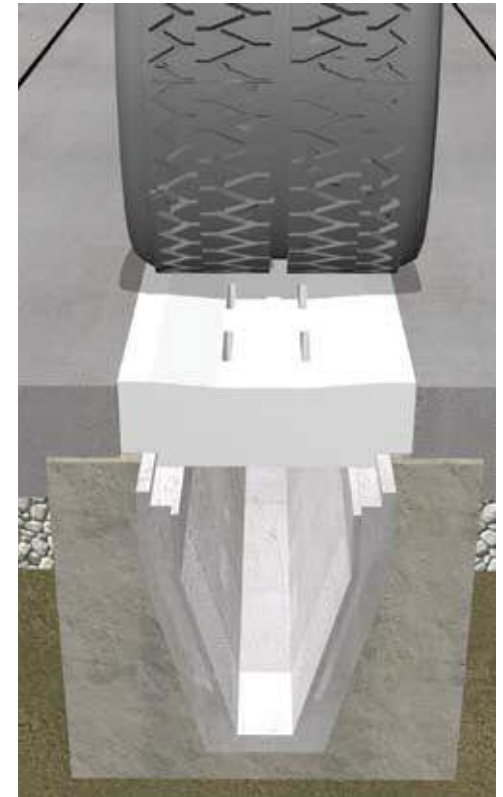

- ▶ sales@althon.co.uk
- ▶ 01603 488700
- ▶ www.althon.co.uk

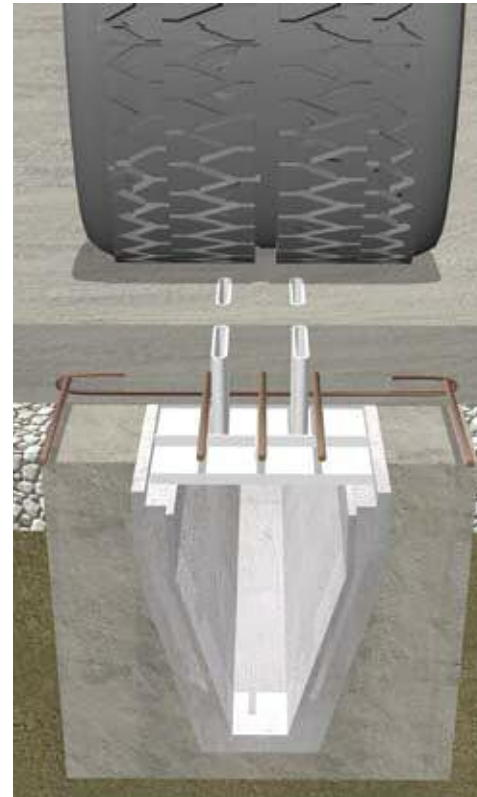
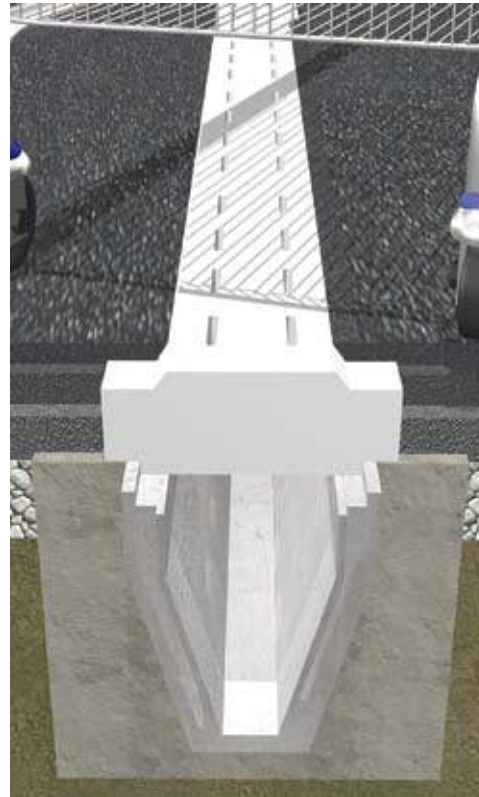
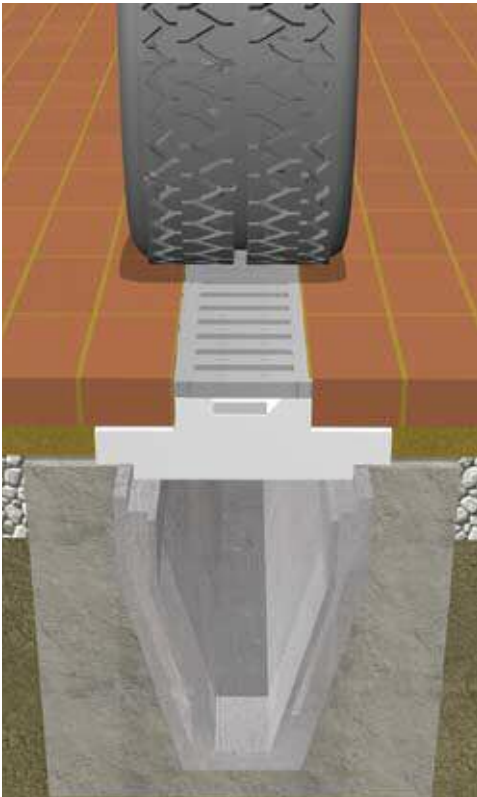

High Capacity Channel Drainage System

The Althon High Capacity Channel Drainage System

contents

Introduction	3
Channel and Lid Descriptions	4-5
Standard Stilpro Lid Units	6
Stilpro BP Lid Units	7
JS3 Lid Units	8
HB/EHB/XHB Lid Units	9
KHB Combined Kerb Lid Units	10
Forma D400 Lid Units	11
Performance and Properties	12
GRC Silt Pits	13
Installation Instructions	14-15



High Capacity Channel Drainage System



Introduction

The original ALTHON system was first introduced some sixty years ago for the efficient drainage of coal heaps. Since then, the product has been supplied to hundreds of projects for the cost-effective drainage of large car parks and other hard standings, including:

Supermarkets, Lorry Parks, Park and Ride Schemes, Motorways and Trunk Roads, Dockyards, Airports, Leisure Parks, Motorway Service Areas, etc.

The ALTHON Surface Water Drainage System comprises a unique trapezoidal high capacity channel manufactured in lightweight GRC in a range of 5 different sizes, along with a range of precast lid units to suit a variety of applications.

High Capacity Channels

The high capacity of the channels enables the installation of long, uninterrupted runs, without the need for intermediate outfalls and offers considerable reductions in the amount of secondary pipework required. This extra capacity is useful for water storage, the largest channel having a capacity for 412 litres per metre.

The ALTHON system is particularly suited to problem sites, including those with a high water table, limited falls and contaminated ground.

Unique Profile Channel

The unique ALTHON trapezoidal channel creates its own velocity even when laid level and is ideal for large, flat or virtually flat sites.

Full Range of Lids

For each of the five different ALTHON channel sizes we offer a choice of different lid sections to suit most applications.

Further details of ALTHON Channels and Lids are to be found in this brochure, under the headings listed on the Contents page opposite.

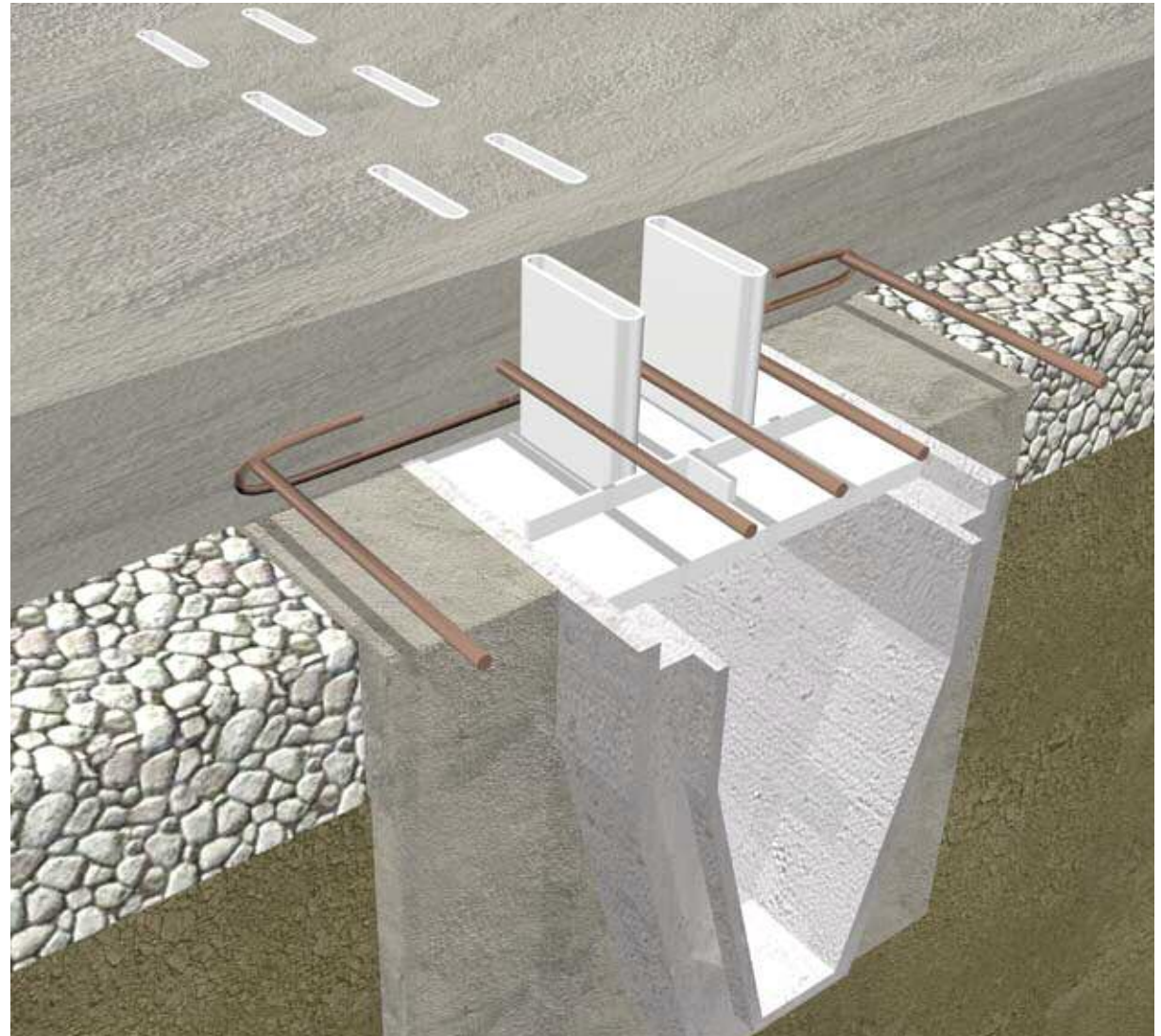

Description

The ALTHON system comprises:

- A range of 5 standard precast GRC channel units.
- High bearing, precast concrete lid units.
- Combined kerb and high bearing lid units.
- Combined concrete lid with cast iron stiletto heel proof grating.
- GRC lid former supplied with reinforcement to suit minimum D400 loading.
- Purpose made silt pit and ductile iron covers.
- Rodding eyes which can be incorporated in lid units where appropriate.
- Stop end inserts available for all channel sizes.

Channels:

ALTHON channel sections are produced in five standard sizes, with dimensions as shown in Figure 1.

Lid units

Nine types of lid unit are available; Stilpro, Stilpro BP, JS3, HB, EHB, XHB, KHB, AL1 and Forma D400. All lid units are to a standard length of 1000mm. See Figure 2 for dimensions.

All drainage slots in the HB, EHB, XHB, KHB, JS3 and Forma D400 lid units are 100mm long, tapering from 15mm at the top to 30mm at the bottom. This reduces the risk of blockage.

Stilpro

Stilpro standard flush macadam lid unit incorporating cast iron stiletto heel proof grating, conforming to C250 loading.

Stilpro B.P.

As Stilpro standard lid unit with upstand for use in block paved areas.

JS3 flush macadam lid

The JS3 lid has been designed to allow a macadam surfacing to finish flush with the centre upstand of the lid, and to provide a constant 250mm wide finished appearance.

HB high bearing lids

The standard high bearing lid units (figure 2) have been designed and tested to 112.5 Kn (45 Units HB) wheel load.

EHB high bearing lids

Designed for areas trafficked by articulated HGV vehicles (sizes as per HB lid).

XHB lid units

Designed to take 50 tonnes. For abnormal fork lift loads as used in rail freight depots and container terminals (sizes as per HB lid).

KHB combined kerb and high bearing lids

A combined kerb and high bearing lid unit, designed specifically for road and highway application. The kerb upstand profile matches that of BS 7263 FIG HB2. N.B. This product is only available in sizes to suit channels CH150, CH250 and CH375.

AL1 lid units

Special aluminium plates for areas where channels are routed under landscaped areas.

Forma D400

GRC lid former supplied with reinforcement for in-situ casting with concrete hardstandings for heavy industrial application. Achieves minimum loading of D400.

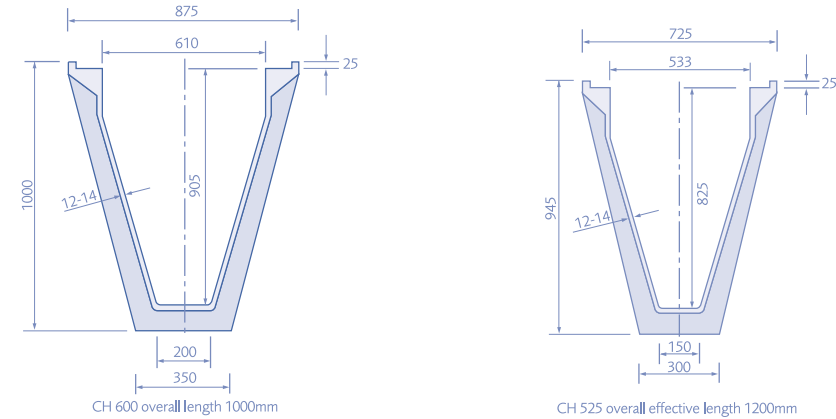

Figure 1: Standard range of Althon channel sections scale 1:20

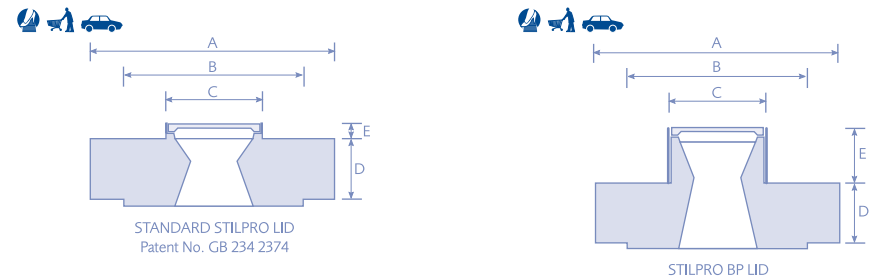
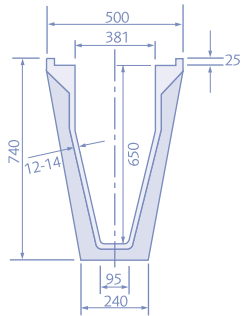

Figure 2: Standard Althon Lid Types scale 1:10

Standard Stilpro Lid Units					
Unit	Dimensions (mm)				
	A	B	C	D	E
150	346	205	123	110	30
250	448	305	123	110	30
375	575	430	123	110	30
525	790	650	123	110	30
600	865	725	123	110	30

Stilpro BP Lid Units					
Unit	Dimensions (mm)				
	A	B	C	D	E
150	346	205	123	110	100
250	448	305	123	110	100
375	575	430	123	110	100
525	790	650	123	110	100
600	865	725	123	110	100

High Capacity Channel Drainage System



CH 375 overall effective length 1500mm

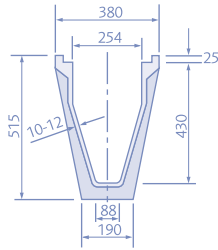

CH 250 overall effective length 2000mm

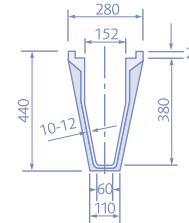

CH 150 overall effective length 2000mm

Key for symbols

- Heel proof pedestrian walkways
- Supermarket car parks
- Large car parks and estate roads
- Service yards and light industrial
- Distribution depots, rail freight and container terminals

This table should be read in conjunction with the Lid descriptions on page 4.

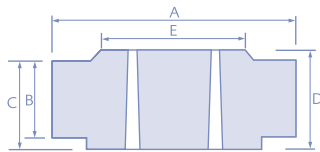

JS3 FLUSH MACADAM LID
Registered Design No. 2015778



EHB or XHB

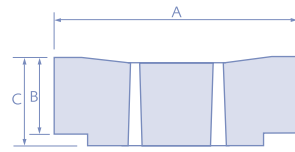

HB/EHB/XHB HIGH BEARING LIDS
Registered Design No. 1058762

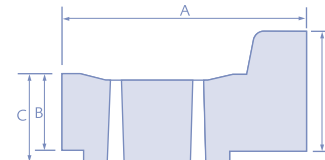

KHB COMBINED KERB AND HIGH BEARING LID
Registered Design No. 2024856

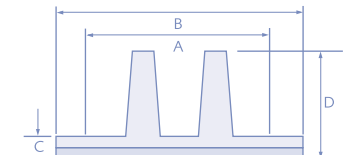

FORMA D400 LID

JS3 Lid Units							
Unit	Dimensions (mm)					No. of slots	
	A	B	C	D	E		
150	346	127	152	182	250	8	
250	448	127	152	182	250	8	
375	575	127	152	182	250	8	
525	790	127	152	182	250	8	
600	940	127	152	182	250	8	

HB/EHB/XHB Lid Units					
Unit	Dimensions (mm)				No. of slots
	A	B	C	D	
150	346	127	152	8	
250	448	127	152	8	
375	575	127	152	12	
525	790	127	152	16	
600	940	127	152	20	

KHB Lid Units					
Unit	Dimensions (mm)				No. of slots
	A	B	C	D	
150	446	127	152	227	8
250	548	127	152	227	8
375	675	127	152	227	12

Forma Lid Units				
Unit	Dimensions (mm)			No. of slots
	A	B	C	
150	222	40	200	8
250	320	40	200	8
375	445	40	200	8
525	665	40	200	8
600	745	40	200	8

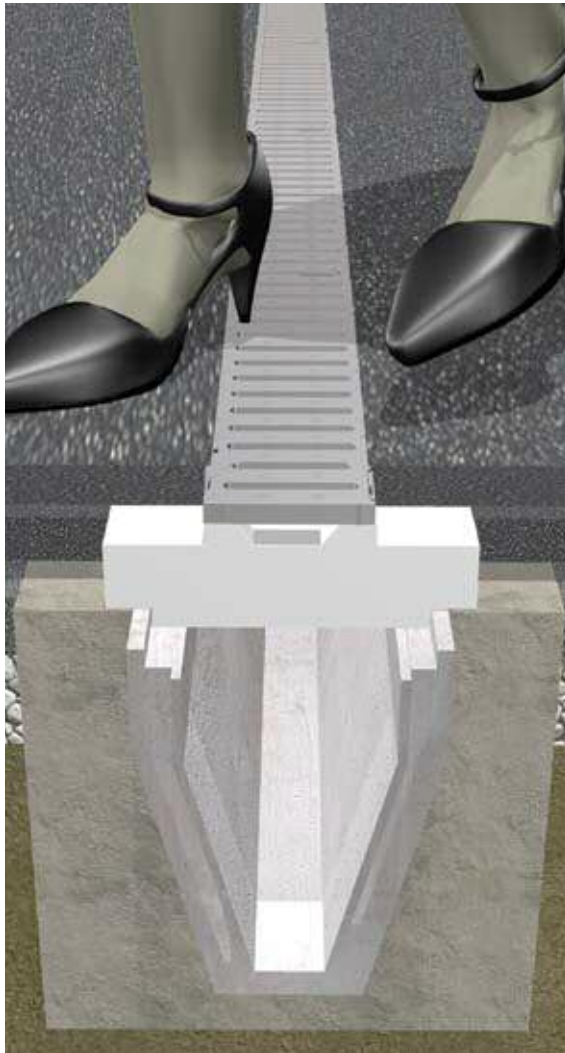

Standard Stilpro Lid Units

The STILPRO Lid was developed in conjunction with landscape architects who expressed a requirement for a standard width cast iron stiletto heel proof grating, whilst utilising the benefits of incorporating an ALTHON High Capacity Channel. The remainder of the lid unit is covered by asphalt or macadam.

- ▣ Loading conforms to BS EN124 Class C
- ▣ Removable gratings for easy maintenance
- ▣ 125mm one width grating for all size channels
- ▣ Grating secured by corrosion free bolt system
- ▣ Epoxy rust proof coating
- ▣ Stiletto heel proof with 5mm slots

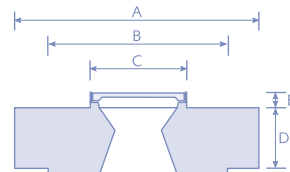

STANDARD STILPRO LID
Patent No. GB 234 2374

Standard Stilpro Lid Units					
Unit	Dimensions (mm)				
	A	B	C	D	E
150	346	205	123	110	30
250	448	305	123	110	30
375	575	430	123	110	30
525	790	650	123	110	30
600	865	725	123	110	30



High Capacity Channel Drainage System



Stilpro BP Lid Units

The STILPRO BP Lid incorporates the same features as the Standard Stilpro Lid but has a deeper upstand to accommodate block paving.

- ▣ Loading conforms to BS EN124 Class C
- ▣ Removable gratings for easy maintenance
- ▣ 125mm one width grating for all size channels
- ▣ Grating secured by corrosion free bolt system
- ▣ Epoxy rust proof coating
- ▣ Stiletto heel proof with 5mm slots

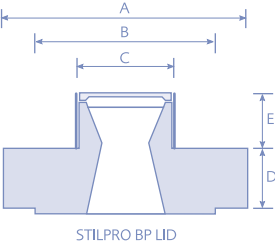

Stilpro BP Lid Units					
Unit	Dimensions (mm)				
	A	B	C	D	E
150	346	205	123	110	100
250	448	305	123	110	100
375	575	430	123	110	100
525	790	650	123	110	100
600	865	725	123	110	100

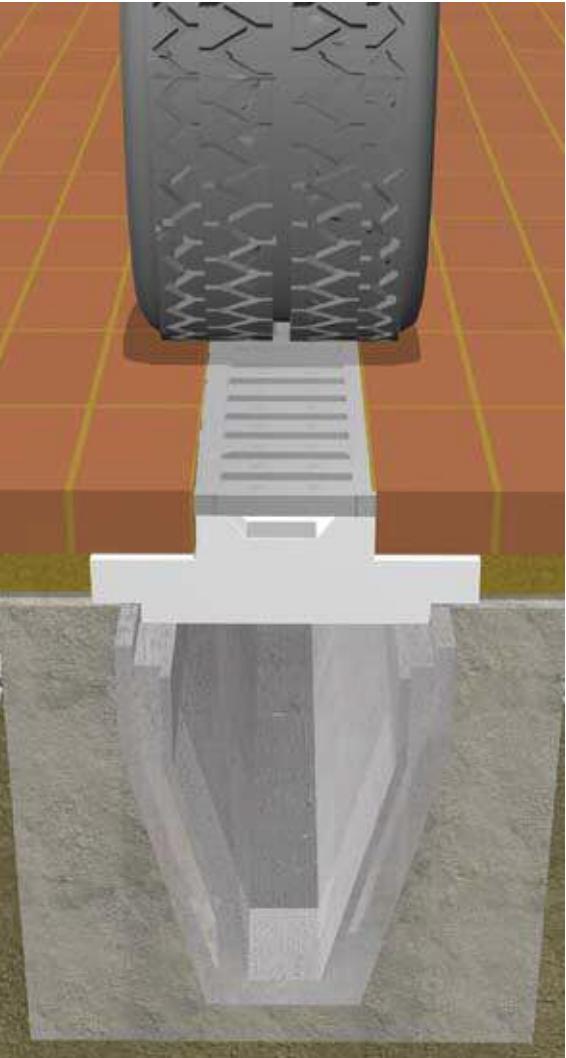

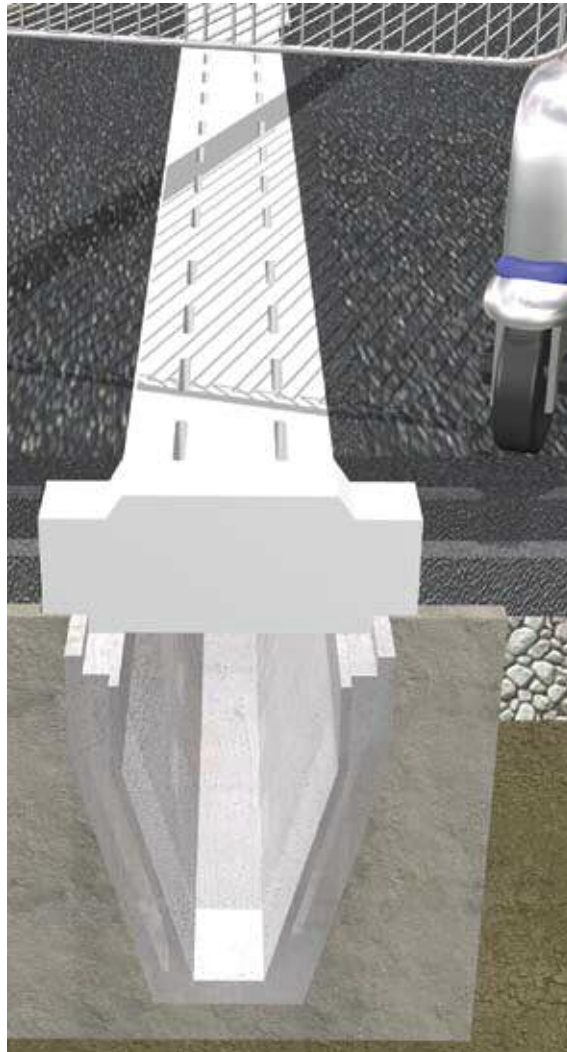

JS3 Lid Units

The JS3 Lid has been designed to allow a standard 250mm central concrete upstand to be visible regardless of channel size. The remainder of the lid is covered by asphalt and can be used where HB loading is required.

- ▣ One visible section common to all channel sizes
- ▣ Suitable for trafficking up to HB loading
- ▣ Slots flared to minimise blockages
- ▣ Rodding eyes can be cast in to facilitate easy maintenance

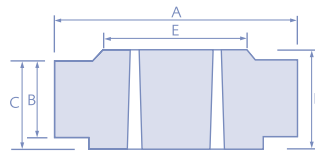

JS3 FLUSH MACADAM LID
Registered Design No. 2015778

JS3 Lid Units						
Unit	Dimensions (mm)					No. of slots
	A	B	C	D	E	
150	346	127	152	182	250	8
250	448	127	152	182	250	8
375	575	127	152	182	250	8
525	790	127	152	182	250	8
600	940	127	152	182	250	8



High Capacity Channel Drainage System



HB/EHB/XHB Lid Units



EHB or XHB

The HB Lid has been designed for use in light industrial areas where the wheel load does not exceed 11.25 tonne and is ideal for sites where vans and occasional lorries are used. If HGV use is frequent and precast units are required, EHB or XHB lids should be used. EHB Lid Units incorporate additional reinforcement to protect against damage caused by dynamic loadings. XHB Lid Units incorporate reinforcement designed to withstand abnormal loadings up to 50 tonnes, and should be used where particularly onerous loadings are anticipated.

- ▣ Precast lid unit
- ▣ Suitable for HB loading
- ▣ Slots flared to minimise blockage
- ▣ Rodding eyes can be cast in to facilitate easy maintenance

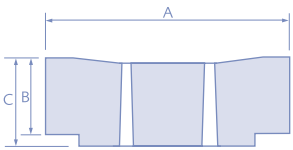

HB/EHB/XHB HIGH BEARING LIDS
Registered Design No. 1058762

Unit	HB/EHB/XHB Lid Units			No. of slots
	Dimensions (mm)			
	A	B	C	
150	346	127	152	8
250	448	127	152	8
375	575	127	152	12
525	790	127	152	16
600	940	127	152	20

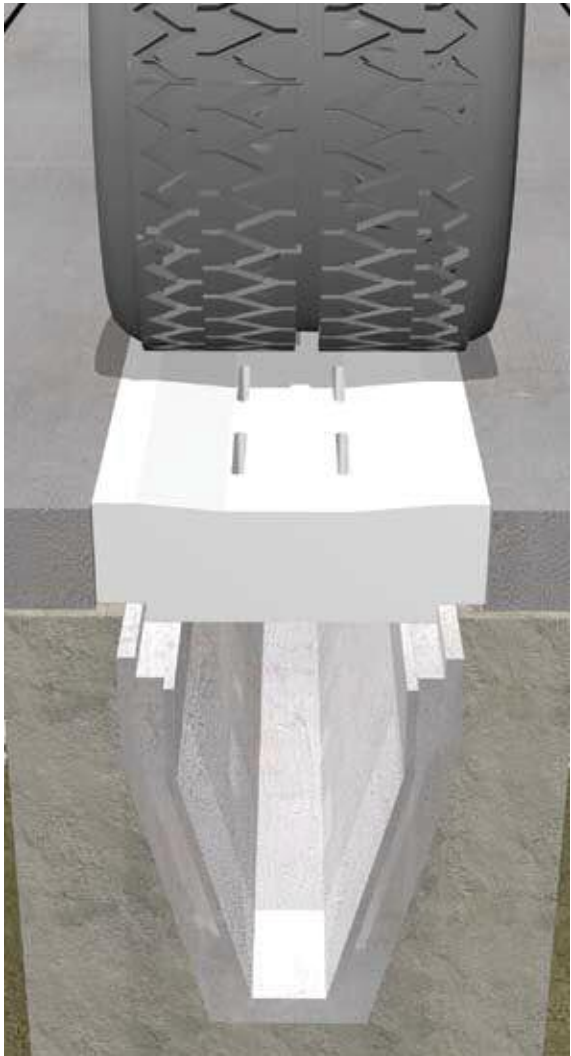

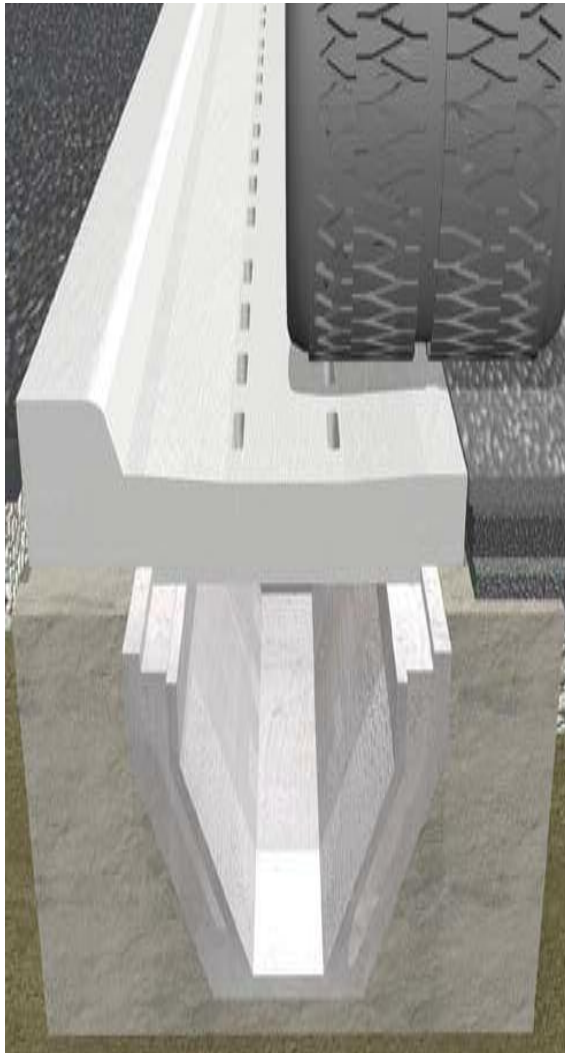

KHB Combined Kerb Lid Units

The KHB combined kerb and lid unit has been specifically designed for estate roads and car park application.

- ▣ Profile matches BS 7263 FIG HB2
- ▣ Suitable for HB loading
- ▣ Slots flared to minimise blockage

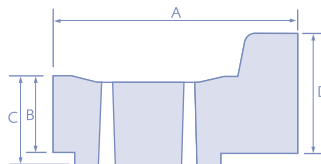

KHB COMBINED KERB AND HIGH BEARING LID
Registered Design No. 2024856

KHB Lid Units					
Unit	Dimensions (mm)				No. of slots
	A	B	C	D	
150	446	127	152	227	8
250	548	127	152	227	8
375	675	127	152	227	12



High Capacity Channel Drainage System



Forma D400 Lid Units

The FORMA lid has been designed for use in heavy duty industrial areas e.g. distribution depots, dock areas, service yards etc. The Forma lid has been tested to D400 loading as standard* and can be further reinforced to take loading up to F900.

- ▣ Standard loading conforms to BS EN1433 category D400*
- ▣ Reinforcement supplied with lid to suit required loading
- ▣ Manufactured in lightweight G.R.C
- ▣ Eliminates risk of lid movement
- ▣ 200 mm depth accommodates most slab depths
- ▣ Supplied with plastic caps to prevent spillage to drainage slots during installation

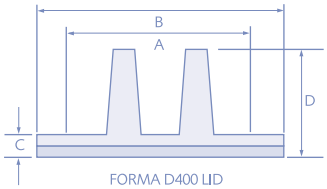

Unit	Forma Lid Units			No of slots
	Dimensions (mm)			
	A	B	C	
150	222	40	200	8
250	320	40	200	8
375	445	40	200	8
525	665	40	200	8
600	745	40	200	8

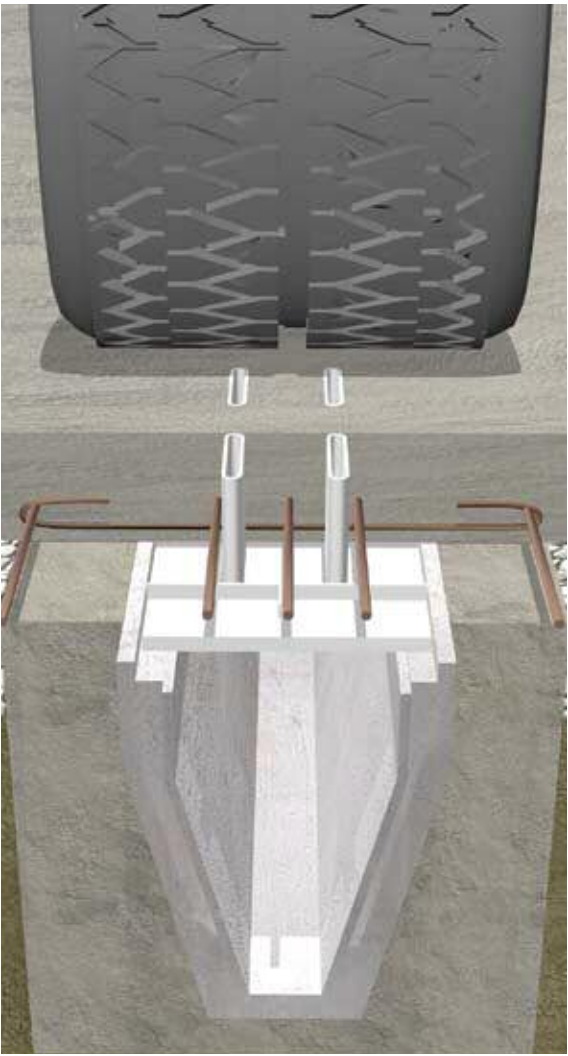

* Tests performed using C50 concrete.
Copies of test results are available upon request

Performance and Properties Channel sizing chart for lateral inflow

	ALTHON 150					ALTHON 250					ALTHON 375				
Rainfall rate		25mm/hr	50mm/hr	75mm/hr	100mm/hr		25mm/hr	50mm/hr	75mm/hr	100mm/hr		25mm/hr	50mm/hr	75mm/hr	100mm/hr
	Flow rate l/s	Area drained m ²	Area drained m ²	Area drained m ²	Area drained m ²	Flow rate l/s	Area drained m ²	Area drained m ²	Area drained m ²	Area drained m ²	Flow rate l/s	Area drained m ²	Area drained m ²	Area drained m ²	Area drained m ²
Channel gradient															
Flat/0%	25	3350	1750	1150	850	40	5200	2600	1700	1250	100	14000	7500	5000	3400
1:500/0.20%	28	4032	2016	1344	1008	60	8640	4320	2880	2160	180	25920	12960	8640	6480
1:400/0.25%	30	4320	2160	1440	1080	71	10224	5112	3408	2556	195	28080	14040	9360	7020
1:300/0.33%	33	4752	2376	1584	1188	75	10800	5400	3600	2700	220	31680	15840	10560	7920
1:200/0.50%	40	5760	2880	1920	1440	95	13680	6840	4560	3420	250	36000	18000	12000	9000
1:100/0.10%	60	8640	4320	2880	2160	140	20160	10080	6720	5040	380	54720	27360	18240	13680
1:50/2%	86	12384	6192	4128	3096	190	27360	13680	9120	6840	520	74880	37440	24960	18720
1:20/5%	140	20160	10080	6720	5040	300	43200	21600	14400	10800	850	122400	61200	40800	30600

	ALTHON 525					ALTHON 600				
Rainfall rate		25mm/hr	50mm/hr	75mm/hr	100mm/hr		25mm/hr	50mm/hr	75mm/hr	100mm/hr
	Flow rate l/s	Area drained Ha	Area drained Ha	Area drained Ha	Area drained Ha	Flow rate l/s	Area drained Ha	Area drained Ha	Area drained Ha	Area drained Ha
Channel gradient										
Flat/0%	190	2.40	1.40	0.90	0.70	290	3.50	2.20	1.40	1.05
1:500/0.20%	360	5.18	2.59	1.73	1.30	460	6.62	3.31	2.21	1.66
1:400/0.25%	400	5.76	2.88	1.92	1.44	570	8.21	4.10	2.74	2.05
1:300/0.33%	450	6.48	3.24	2.16	1.62	610	8.78	4.39	2.93	2.20
1:200/0.50%	550	7.92	3.96	2.64	1.98	750	10.80	5.40	3.60	2.70
1:100/0.10%	800	11.52	5.76	3.84	2.88	1200	17.28	8.64	5.76	4.32
1:50/2%	1200	17.28	8.64	5.76	4.32	1600	23.04	11.52	7.68	5.76
1:20/5%	1750	25.20	12.60	8.40	6.30	2500	36.00	18.00	12.00	9.00

Storage capacity of channel to underside of lid for attenuation	
Channel size	Capacity l/m
150	51
250	87
375	184
525	325
600	412

Flow rates are for channels running full to underside of lid. Based on Colebrook-White formula adopting a channel roughness of $K_s=1.0\text{mm}$ (equivalent to Manning's $n=0.012$). Shaded areas indicate velocities of 3m/s or greater.

GRC Silt Pits

Manufactured in glass reinforced cement, Althon Silt Pits are lightweight, strong and easy to handle. No shuttering or expensive brickwork is required to connect the Althon channels to any new or existing drain. The Silt Pits are scored on three sides with the profile of the Althon channels, making them easy to cut with an abrasive disc angle grinder. Althon Silt Pit formers are designed to fit onto 600 x 600 pre-cast concrete extension sections.

Size

600 x 600 x 900mm overall height. (Suits CH150, CH250 and CH375 channels).

750 x 600 x 1100mm overall height. (Suits up to CH375 Channel on 600mm side; up to CH600 Channel on 750mm side).

Silt Pit construction

Where it is considered desirable to have silt pits within the drainage run, a suitable construction can be devised using purpose made Althon ductile iron manhole covers with reinforced frames in conjunction with Althon channels and lids.

Figures 3a, 3b and 3c show suggested arrangements for CH150, CH250, CH375, CH525 and CH600 Units. Figure 3 gives a sectional view of the Althon channel and lid unit, GRC silt pit and Althon ductile iron manhole cover and reinforced frame. The depths of the frame and the lid are both 150mm*, so that both require the same thickness of mortar bedding; 10-15mm is recommended. (Class 1 for light duty applications, Althon High Strength Bedding Mortar for heavy duty applications).

The lid unit locating upstands on the channel top edge must be removed for a distance of 200mm from the pit end so that the frame will clear the channel. The lid unit needs to be left short of the frame to allow for concrete backfilling round the frame flange.

Figure 3a shows a typical junction arrangement using a 600 x 600mm silt pit in conjunction with CH150, CH250 or CH375 channels.

Figure 3b shows a typical channel dimension adjustment using a 600 x 600mm silt pit in conjunction with CH150, CH250 or CH375 channels.

Figure 3c shows CH525 and CH600 units entering a silt pit at right angles.

In all cases where a CH525 or CH600 unit is used, the illustrated larger frame is required. Its wider opening of 750mm will accommodate the CH525 or CH600 unit. In the case of the CH600 units, the sides of the channel must be cut away to give a maximum width of 650 mm.

If installing CH525 or CH600 units at right angles to each other then further advice should be sought.

*When using Forma D400 and Stilpro BP lid units it will be necessary to raise the level of the manhole cover and frame with a GRC silt pit raising piece, as detailed in Figure 3d using the appropriate bedding mortar.

Connection to outfall pipes

Outfall pipes can be connected to the silt pit by core drilling the unit at the required invert level and pipe diameter as shown in Figure 3e. Larger or deeper connections can be accommodated by the construction of a sump beneath the Althon Silt Pit.

Cutting on site

Where lids or channels are cut to length, the ends should be painted with bitumen to protect the reinforcement.

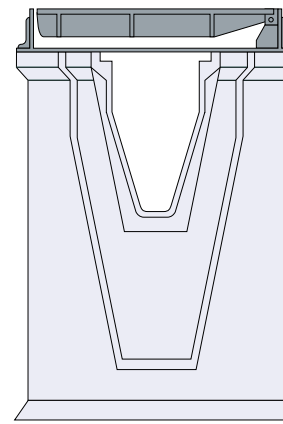

FIGURE 3: SILT PIT

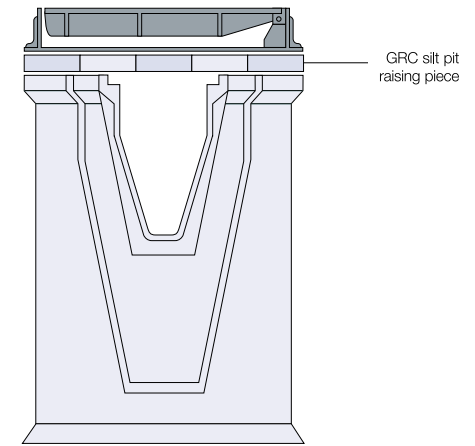

FIGURE 3d: SILT PIT WITH GRC RAISING PIECE

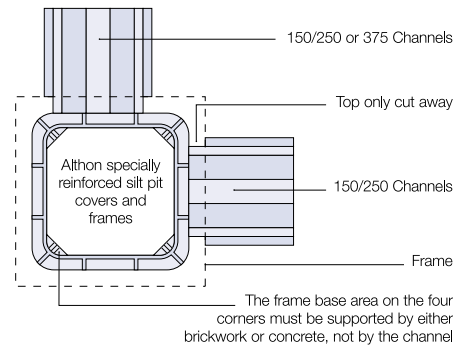

FIGURE 3a: SILT PIT WITH 150 OR 250 UNITS

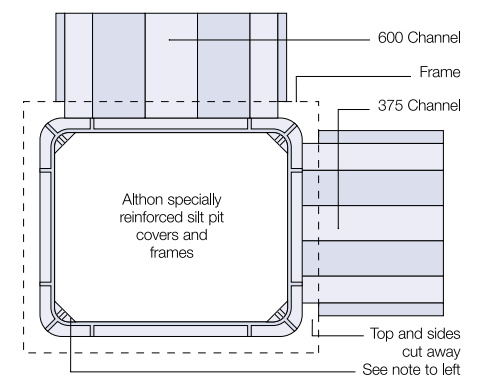

FIGURE 3c: SILT PIT WITH 600 and 525 UNITS

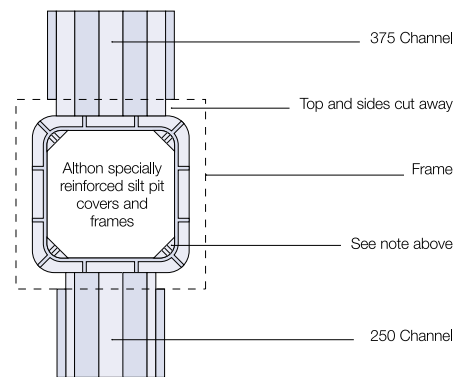

FIGURE 3b: SILT PIT WITH 375 AND 250 UNITS

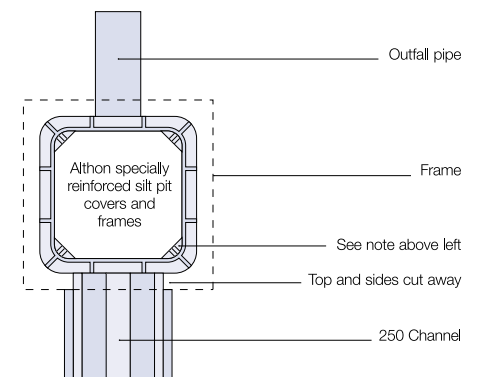

FIGURE 3e: SILT PIT WITH CHANNEL AND OUTFALL PIPE

Installation Instructions For Heavy Duty Applications

Sitework

The following installation procedures are for guidance only, and the person or organisation responsible for the structural design of the adjacent works should satisfy themselves of the suitability of any details for their particular situation.

The following notes apply to the use of ALTHON GRC Channels and GRC Forma D400 Lids and Precast Lids in heavy-duty applications.

Installation of Channels

1. Excavate trench to line and level, having due regard for the size of the channel unit to be installed.
2. Ensure that there is a firm foundation to the bottom of the trench; otherwise seek expert geotechnical advice. Place 150mm minimum concrete grade ST4 in the bottom of the trench. If aggressive chemical conditions exist in the soil or ground waters, an enhanced concrete to suit must be specified.
3. Starting at the outfall end, lower the first channel unit onto the ST4 bedding, then dry joint successive units. Alternatively, depending on the ground conditions, a

trowel grade mastic can be used between adjacent units. Line and level the units with laser or other appropriate technique using the minimum solid packing under the channel.

4. Place ST4 grade concrete backfill surround to the channel, tamped or rammed as necessary to fill all voids, and finishing with a haunch 125mm to 250mm from the top level of the channel as shown in Figure 4.

Installation of Forma Lid Unit (Figure 4)

1. Bed the GRC lid liners into the channel rebates, using Althon High Strength Bedding Mortar. The bedding should be for the full width of the rebate and continuous along the channel.
2. Place the ALTHON supplied pre-fabricated reinforcement cages over the FORMA Lid Unit; the transverse bottom bars sit on the GRC ribs, (see diagram) of the FORMA Lid.
3. The longitudinal bars in the cages are to be lapped by a length of 40 x the diameter of the bars and firmly wired together.
4. Top up the channel surround using paving quality concrete

and then cast the in-situ reinforced concrete lids to the widths specified in Table 1. If greater widths are required, the designer must provide details of the reinforcement etc to ensure correct performance of the lids.

5. Ensure that the lid concrete is fully compacted, care being exercised to avoid damage to the GRC lid liners.

6. Care must also be exercised to prevent concrete spillage down the pre-formed slots that could block the slots or the channels. Plastic caps are supplied for this purpose.

7. Appropriate curing regimes should be adopted depending on the climatic conditions to ensure full strength development in the concrete before traffic is allowed on the lids.

Table 1: Dimension 'X' minimum width of in-situ concrete	Channel	Dimension 'X' mm
	150	600
	250	700
	375	825
	525	1050
	600	1200

FIGURE 4: FORMA D400 UNIT

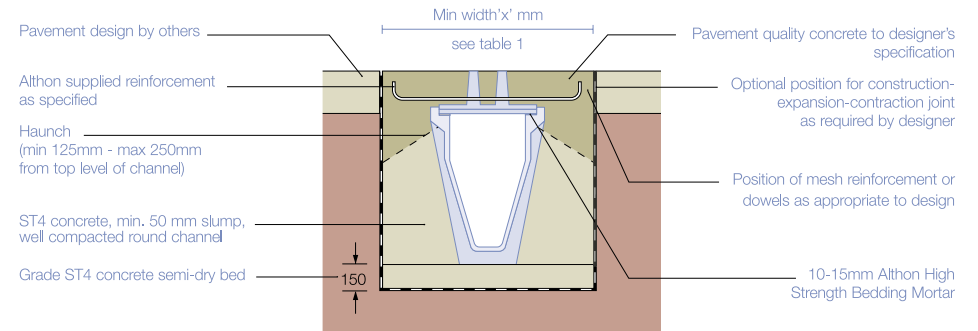
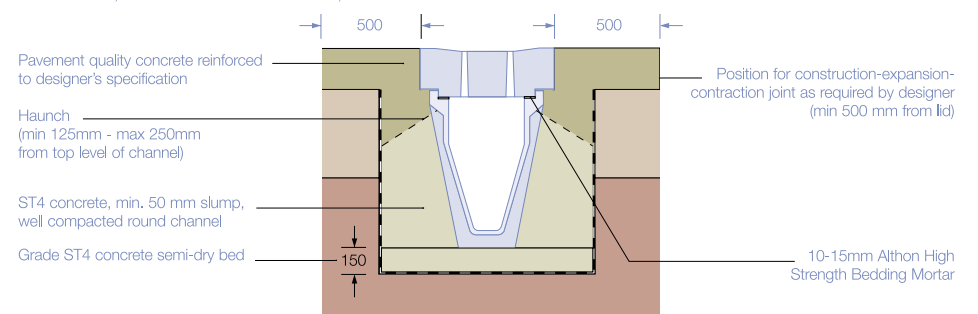

FIGURE 5: HB, EHB OR XHB RIGID PAVEMENT, HGV AND SERVICE YARD AREAS



Movement Joint

1. Transverse movement joints with 10mm thickness of compressible material through both the in-situ lids and the concrete surrounding the channel should be provided at approximately 10.0m intervals, unless the hard standing designer specifies otherwise.
2. The exposed joint on the top surface must be sealed with grey polysulphide sealant, applied in accordance with the manufacturers' instructions.

Rodding Positions - Forma D400

Silt Pits should be positioned at the head of each run for rodding purposes.

Installation of HB, EHB or XHB Lid Unit (Figure 5)

1. Bed the lid on the Channel Unit using Althon High Strength Bedding Mortar.
2. Top up the Channel surround using paving quality concrete ensuring that the concrete fills all voids on the underside of the lid.
3. An expansion/contraction joint should be placed parallel to each side of the lid unit at a minimum distance of 500mm.

Rodding Positions - HB/EHB/XHB Lids

Lid Units with cast in rodding eyes should be positioned at the head of each run for rodding purposes.

Althon Bedding Mortar

Althon Bedding Mortar is a fully pre-mixed dry-pack and only requires the addition of water on site. It should be applied in a thickness of 10-15mm between the top rebate of the Althon Channel and Lid Unit. Althon Bedding Mortar achieves exceptional bonding strength without shrinkage. Althon Bedding Mortar is available in 25kg poly tubs and usage rates are as follows:

Forma D400 Lids – 1 Tub per 10m of channel. All other Lids – 1 Tub per 5m of channel.



Installation Instructions For Standard Applications

Installation Method for Channel and Lids.

1. Excavate trench to line and level, having regard to the size of unit to be installed.
2. Concrete the bottom of the trench with 75mm minimum thickness ST4 concrete on firm foundation.
3. Starting at the outfall end, lower the unit carefully onto an ST4 bed.
4. Dry joint successive channel units. Depending on ground conditions mastic can be used to seal joints on engineers recommendations.
5. Align channels by using laser or similar instrument.
6. Concrete surround to top level of channel rebate and allow to cure.
7. Bed lid on to channel with class 1 mortar with 10-15mm bed ensuring that the bedding is on both levels of rebate.
8. Bring up road base and finished pavement to sides of lid, or over lid where appropriate.

FIGURE 6: HB LID WITH BLOCK PAVIOURS AND ASPHALT

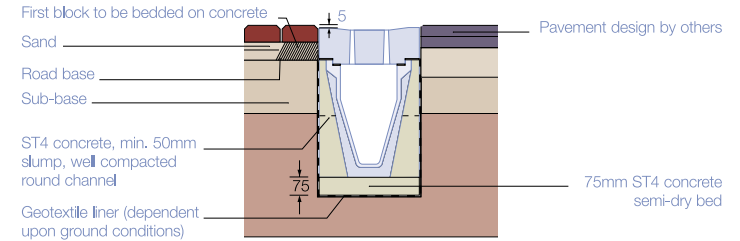

FIGURE 7: JS3 LID WITH ASPHALT

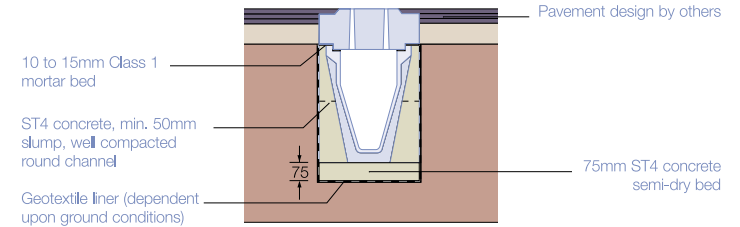

FIGURE 8: KHB LID WITH ASPHALT

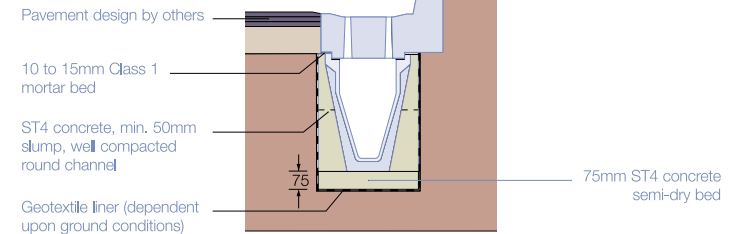

FIGURE 9: STANDARD STILPRO LID WITH ASPHALT

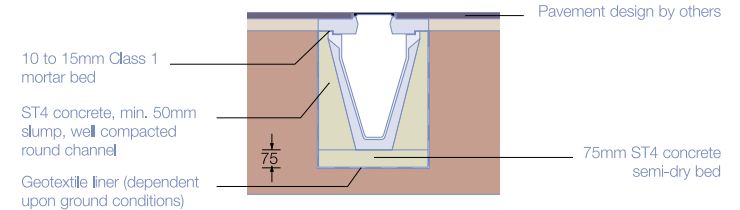

FIGURE 10: STILPRO BP LID WITH BLOCK PAVIOURS

