

Chieftan Chamber (Inspection Chamber)

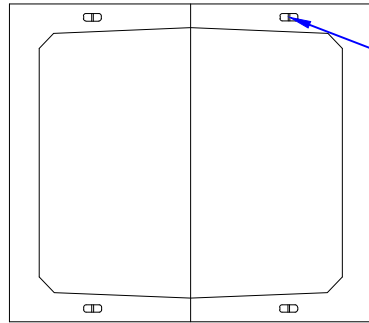

See detail A

PLAN VIEW WITH LID REMOVED



Lifting ring clutch

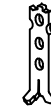

Detail 'A'
'Cast in' Universal anchor point

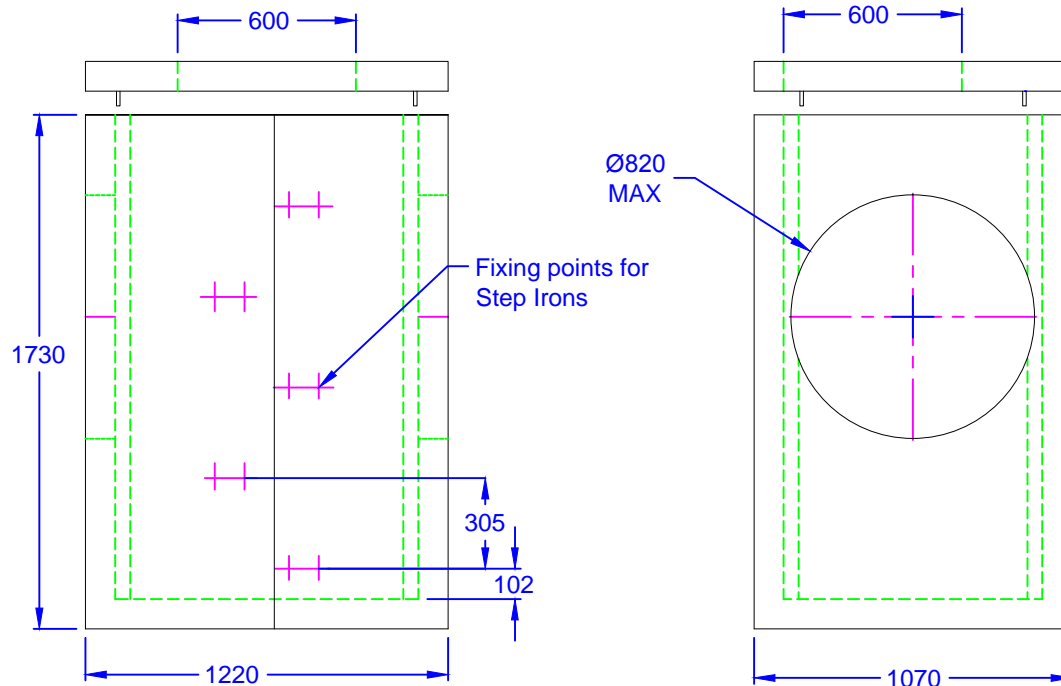
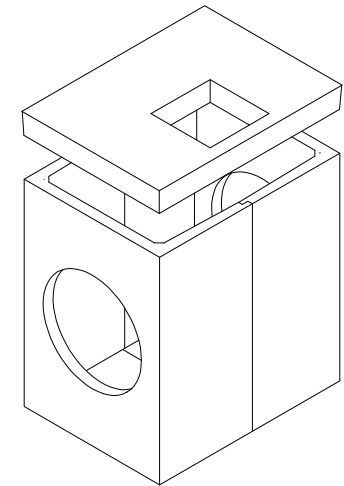

SIDE VIEW OF CHAMBER

Installation

Units should be bedded on minimum 100mm of ready mixed concrete. Each section should be hoisted into position separately ensuring that the two sections butt together correctly. Use the galvanised bolts through the the fixing brackets at each side to keep the units together during back filling

Material: Reinforced Concrete

Weight Approx: 1890kg + 220kg lid

All Dimensions in mm



ALTHON LIMITED, VULCAN ROAD SOUTH, NORWICH NR6 6AF
TEL 01603 488700 FAX 01603 488598

1220 x 1070 - 1730mm high

Chieftan Chamber