

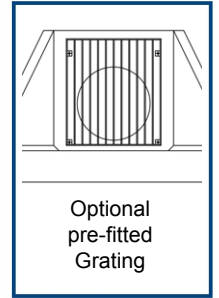

H50C Headwall Range

Up to 600mm Pipework
Approximate weight 900kg

A one piece concrete headwall to suit pipes up to 600mm ID. These headwalls can be used when the ditch bank is very shallow approx 1:3. They can be provided with fixings for gratings, flap valves or a full length sloped grating.

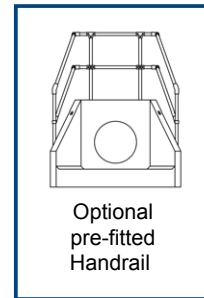
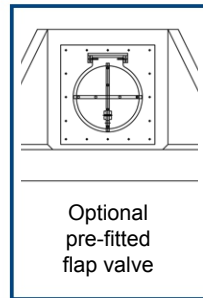
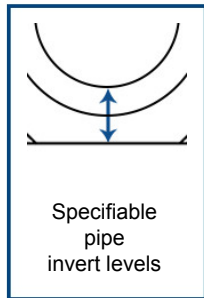
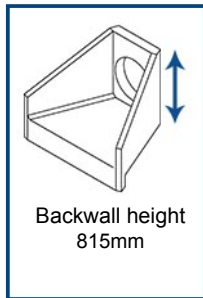
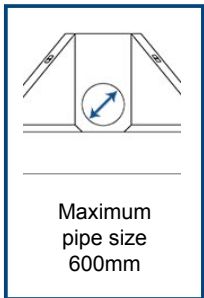
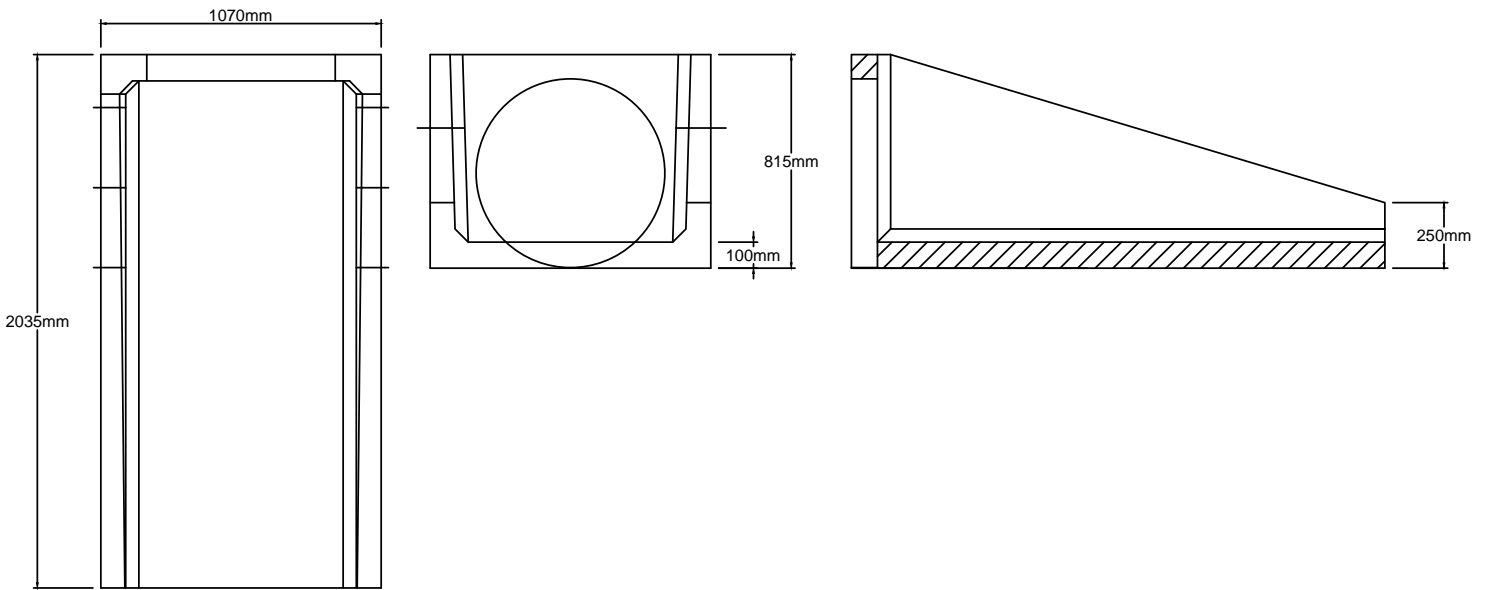



Installation Guide

Once installed correctly the ground pressure of a headwall is low (approximately 6.5kn/m²) Althon suggest a minimum sub base of 100mm dry mix concrete to give a foundation to sit the headwall onto

1. Ensure that the pipe is fully fitted leaving either the first (or last) section of pipe free from backfill in order to attach to the headwall
2. Dig out the bank of the watercourse to take the size of the headwall making sure that the headwall will not protrude into the path of the water flow
3. Dig out sufficient size trench to take the toe along the front of foundation allowing for sufficient room to manoeuvre the headwall over the end of the pipe
 - If an extended toe is to be fitted then increase the depth of the excavation as required
 - If very large pipes are being used, it is recommended that a 500mm wide x 500mm deep trench filled with mass concrete is constructed under the back edge of the headwall to cover the possibility of the heavy pipe resting upon the opening within the back wall of the headwall.
4. Lay a minimum (varies with ground conditions) of 100mm thick bed of dry mix concrete as a foundation to rest the headwall on. Althon recommend creating a slight fall of 1:50 from pipe to spill mouth
5. Prior to lifting and positioning the headwall all attachments such as gratings and water control gear should be removed
 - If there is a bolt on extended toe fully thread the M16 stainless steel studding into the fixing sockets of the toe and lift this into position first. Once the headwall is installed on top of the toe use washers and nuts to fix the headwall and toe together. Once the nuts have been sufficiently tightened fill the holes with mortar
 - Do not exceed a torque setting of 40Nmm² when tightening bolts.
6. Lift the headwall into position using 3no RD20 threaded lifting eyes, long adjustable chains and suitable machinery. Before carrying out the lifting operation all relevant personnel involved should read the installation and lifting guide in this document and a detailed lift plan and risk assessment should be completed by a competent person
 - The 3no RD20 threaded lifting sockets are all located in the base of the headwall
 - Placing a shim at the bottom of the pipe will assist with centring it in position
 - If attachments such as water control gear or gratings are to be fitted to the headwall – the pipe must be fitted flush with the inside of the back wall
 - If there are no attachments to be fitted Althon recommend fitting the headwall so that the pipe protrudes 50mm through the back wall
7. When satisfied with positioning backfill in front and under the headwall toe with mass concrete

8. Backfill around the pipe with either mass concrete or well-compacted impervious clay. If concrete has been used around the pipe then proceed with soil backfilling to the top level of the structure ensuring good compaction as you go

9. Depending on soil conditions and specific site requirements Althon recommend backfilling around wing walls with well compacted impervious clay

10. Using an appropriate mortar or resin fill in the gap between the pipe and headwall around the opening in the back wall of the headwall

11. For fitting gratings and other fabricated metal components

- Position the grating using appropriate lifting equipment
- Use the correct size and length of stainless steel bolts with washers to fix
- Gratings to the threaded fixing sockets cast into headwalls
- To prevent bolts binding in threaded fixing sockets copper slip must be applied to the thread of all bolts
- Do not exceed a torque setting of 40Nmm² when tightening bolts.

12. For fitting water control gear (i.e. Flap Vales & Penstocks)

- Apply foam seal or mastic sealant to the back plate of the water control gear to ensure a watertight seal between the headwall
- Position the water control gear using appropriate lifting equipment
- Use the correct size and length of stainless steel bolts with washers to fix control gear to the threaded fixing sockets cast into headwalls
- To prevent bolts binding in threaded fixing sockets copper slip must be applied to the thread of all bolts. Do not exceed a torque setting of 40Nmm² when tightening bolts. Overtightening bolts may distort the back-plate thus preventing the valve from sealing correctly

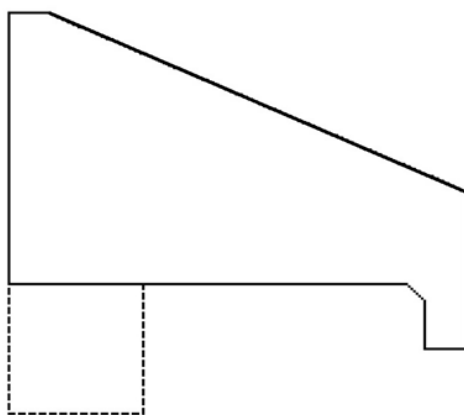

500 x 500 trench filled with mass concrete to support any pipe loading.

Due to the wide variety of site conditions this is only intended to be a guide, it is inappropriate to give specific information regarding details such as the depth of foundations to support the headwall or a detailed lift plan & risk assessment.