

## SFA20 Headwall Range

Up to 1500mm Pipework  
1300mm - 2350mm Backwall Height

300 and 500mm Thick Toe

Althon Sewers for Adoption precast headwalls should be used when a concrete headwall is part of a Section 104 Agreement and the sewers are to be adopted once completed by the local Water Company. The materials used and installation must comply with the 'Sewers for Adoption' guidelines. Althon SFA precast concrete headwalls offer a cost effective alternative to in-situ structures for connecting pipework discharging into open watercourses.

There are four sizes of Sewers for Adoption concrete headwalls available catering for pipe sizes up to and including 1500mm. Each size of SFA precast concrete headwall comes with three depths of toe and four back wall heights offering wing wall profiles to suit most applications.

Althon Sewers for Adoption precast concrete headwalls are cast to suit the diameter and type of pipe being used and can be provided with fixings cast in at the time of manufacture to accommodate gratings, trash screens, flap valves, penstocks, ladders, Kee Klamp® handrails and flow and depth monitoring equipment.

Our Sewers for Adoption compliant precast headwalls are available with toe extensions either 300 or 500mm thick with depths ranging from 450 to 1000mm. We also manufacture Sewers for Adoption compliant outfall safety grilles to suit our concrete headwalls.

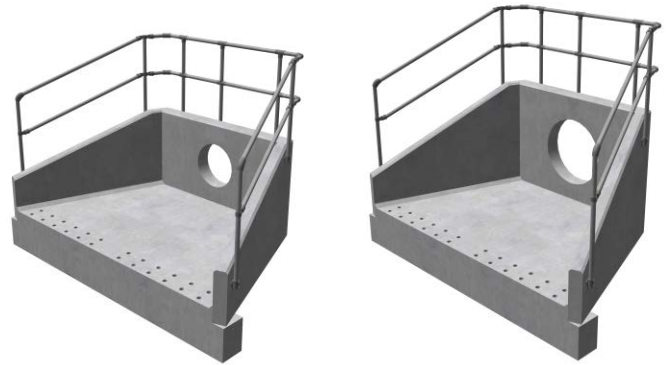

SFA20 A  
1300mm Backwall  
2 Piece Headwall

SFA20 B  
1650mm Backwall  
2 Piece Headwall

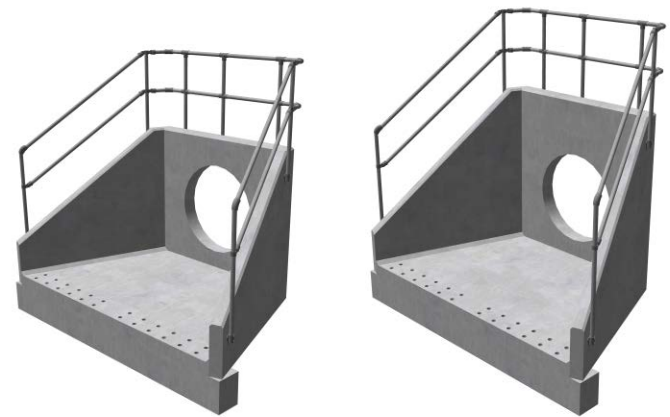

SFA20 C  
2000mm Backwall  
2 Piece Headwall

SFA20 D  
2350mm Backwall  
2 Piece Headwall

Optional Kee Klamp handrail

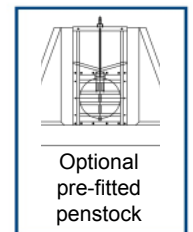
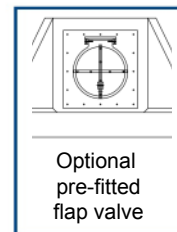
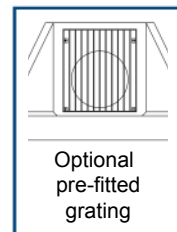
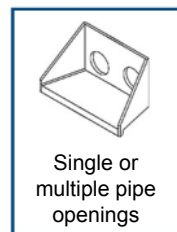
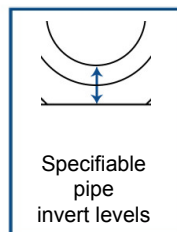
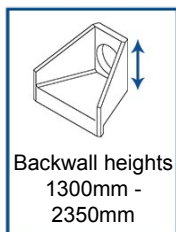
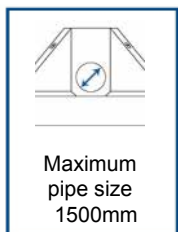
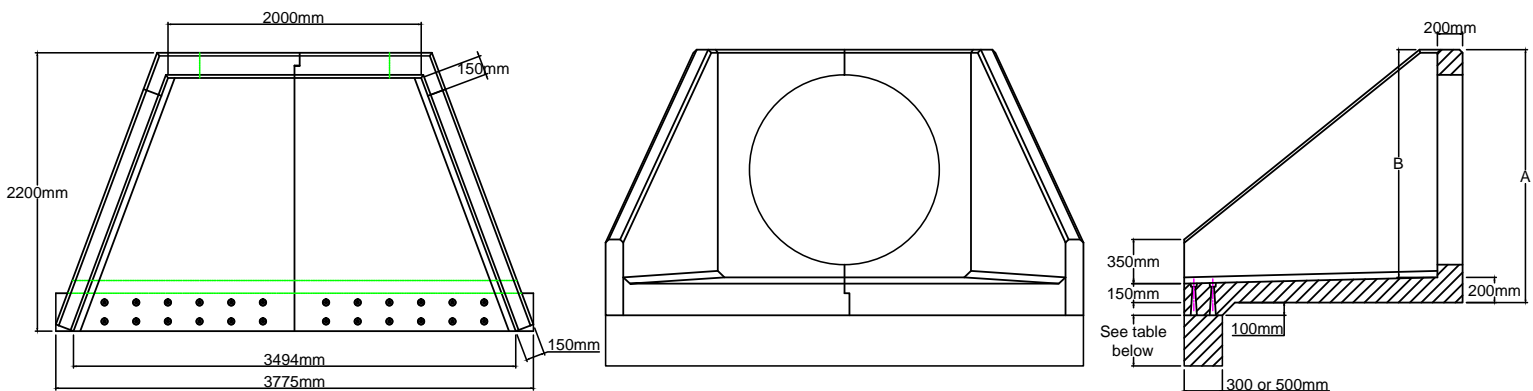

## SFA20 Headwall Range

Up to 1500mm Pipework  
1300mm - 2350mm Backwall Height

300mm Thick Toe

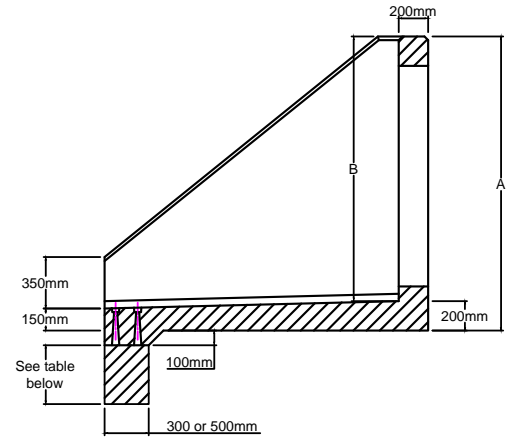

Headwall Ref	Back Wall Height A	Back Wall Height B	Wing Wall Profile	Weight	Weight with Toe			Max Pipe Opening	Max Pipe Opening	Max Pipe Opening	Max Pipe Opening	Max Pipe Opening	Max Pipe Opening
					400mm	650mm	950mm						
								Invert Level with Apron		100mm Invert Level		225mm Invert Level	
								TW / Clay	Concrete	TW / Clay	Concrete	TW / Clay	Concrete
	mm	mm		kg	kg	kg	kg	mm	mm	mm	mm	mm	mm
SFA20A	1300	1100	1:2.3	5660	6755	7410	8120	750	825	750	675	600	600
SFA20B	1650	1450	1:1.6	6070	7165	7820	8530	1200	1050	1050	1050	900	900
SFA20C	2000	1800	1:1.24	6730	7825	8480	9190	1500	1350	1200	1350	1200	1200
SFA20D	2350	2150	1:1	7390	8485	9140	9850	1500	1500	1500	1500	1500	1500

## 500mm Thick Toe

Headwall Ref	Back Wall Height A	Back Wall Height B	Wing Wall Profile	Weight	Weight with Toe			Max Pipe Opening	Max Pipe Opening	Max Pipe Opening	Max Pipe Opening	Max Pipe Opening	Max Pipe Opening
					500mm	750mm	1000mm						
								Invert Level with Apron		100mm Invert Level		225mm Invert Level	
								TW / Clay	Concrete	TW / Clay	Concrete	TW / Clay	Concrete
	mm	mm		kg	kg	kg	kg	mm	mm	mm	mm	mm	mm
SFA20A	1300	1100	1:2.3	5660	7484	8624	9764	750	825	750	675	600	600
SFA20B	1650	1450	1:1.6	6070	7894	9034	10174	1200	1050	1050	1050	900	900
SFA20C	2000	1800	1:1.24	6730	8554	9694	10834	1500	1350	1200	1350	1200	1200
SFA20D	2350	2150	1:1	7390	9214	10354	11494	1500	1500	1500	1500	1500	1500

## SFA Grate, Ladder and Steps

Headwall Ref	Max Pipe Opening	Max Pipe Opening	Max Pipe Opening	Max Pipe Opening	Max Pipe Opening	Max Pipe Opening
	TW / Clay	Concrete	TW / Clay	Concrete	TW / Clay	Concrete
	mm	mm	mm	mm	mm	mm
SFA20A	600	600	500	450	500	450
SFA20B	900	900	500	450	500	450
SFA20C	1050	1050	500	450	N/A	N/A
SFA20D	1200	1200	500	450	N/A	N/A

# Installation Guidelines

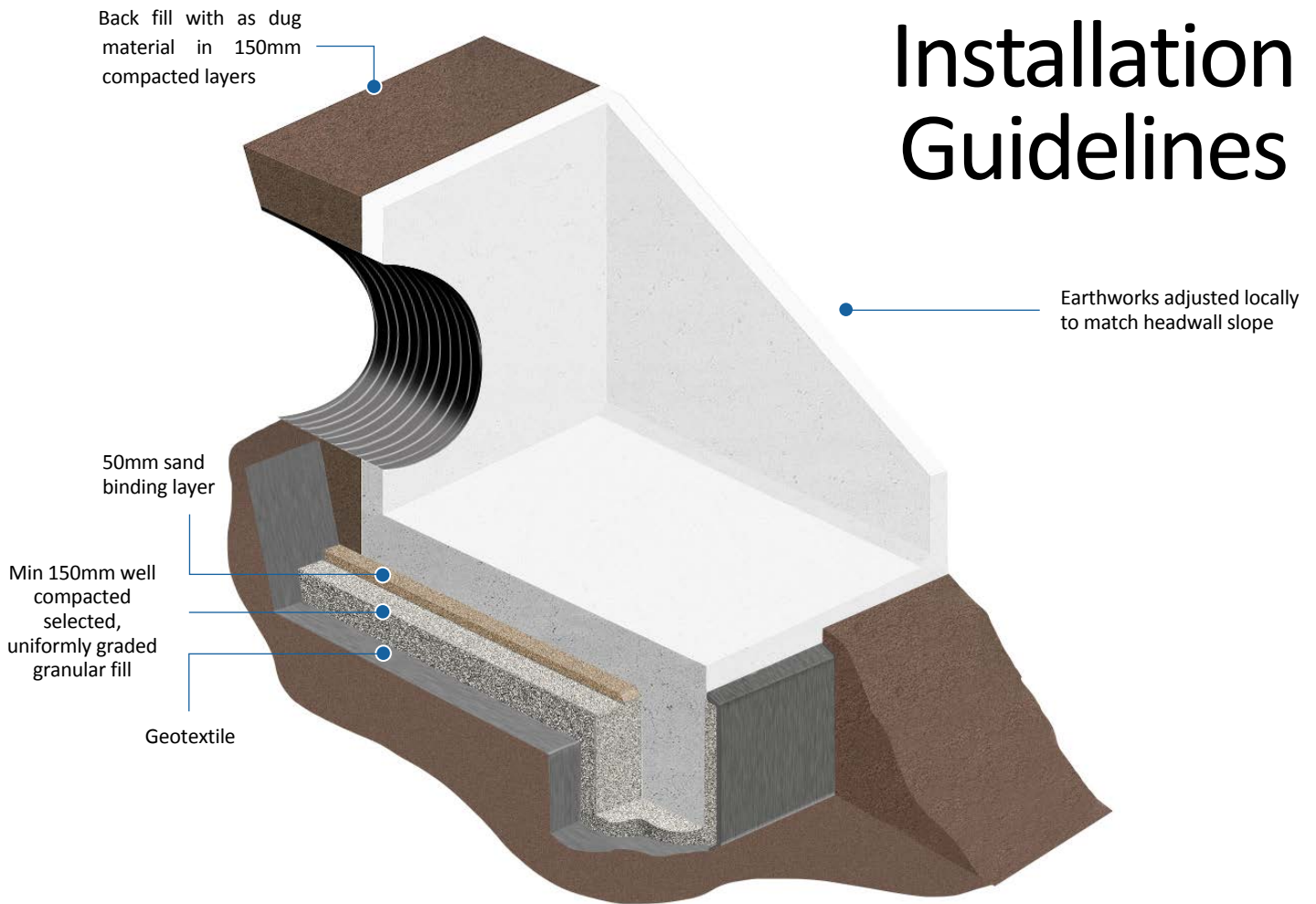

- 1 Ensure that first or last spigot/butt or socket/butt pipe that is to be fitted to the Headwall is in position and free from backfill.
- 2 Dig out the bank of the watercourse to take the size of the headwall making sure that the Headwall will not protrude into the path of the water flow. The angle of the excavation to the rear of the Headwall should be roughly the same as the existing bank profile.
- 3 Dig out sufficient size trench to take the toe along the front of the foundation.
- 4 Line toe foundation with Geotextile then place selected, uniformly graded granular fill in the base and compact well. Lift Toe into position and level then fill around the toe with selected, uniformly graded granular fill and compact well. Insert supplied threaded rod into the sockets cast into the top of the toe.
- 5 Line the base of the rest of excavation with Geotextile then place a minimum bed of 150mm Class 6A\* Selected Well Graded Granular Material on the base & compact well, especially around the back of the toe, then a 50mm blinding layer of sharp sand. Lift Headwall into position, over the end of the pipe & locate over threaded rod protruding from the toe and level. Place washer over threaded rod (SFA10 8 No) in recess in Headwall apron and tighten nut. Fill recess with high strength non-shrink grout.
- 6 The pipe should be flush with the front of the back wall if fitting grating or flap valve, or protruding by 50mm if not.
- 7 Shim the pipe until it is central within the opening then fill void with sand cement mortar or high strength non-shrink grout.
- 8 If flap valve or grating is supplied, this will need to be removed before the pipe is inserted and sealed into place. Then reinstall using stainless steel fixing bolts into cast in sockets. (When bolting flap valves against headwall, use a good quality sealant but do not over tighten bolts or distortion may occur resulting in the valve not seating correctly.
- 9 Backfill pipe section first then backfill all around Headwall with as dug material. Make good at front of toe with as dug material ensuring river bank is returned to its original profile. It may be necessary to provide protection in front of the toe, please refer to engineers' recommendation.

\*Manual of Contract Documents for Highway Works: Volume 1 (MCHW1), Specification for Highway Works, Series 600 (Nov 09)

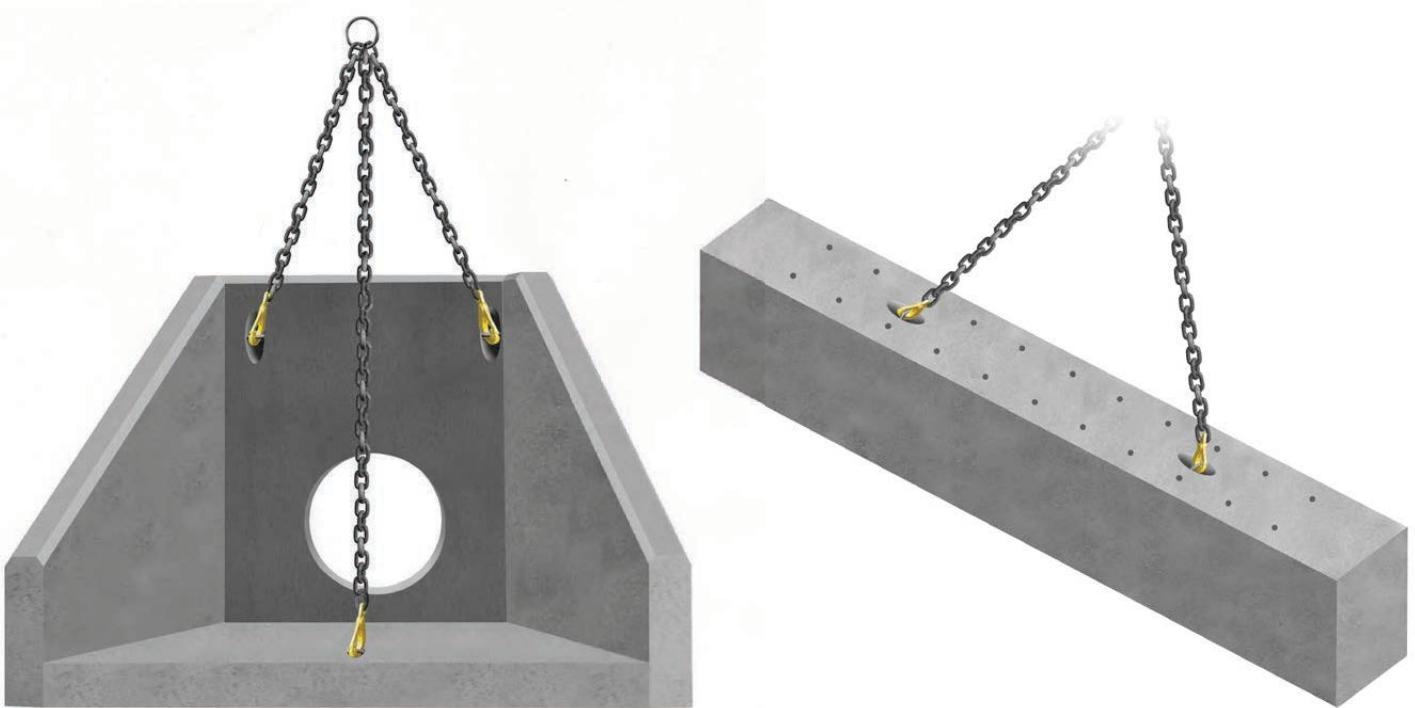

## Rapid-Lift Lifting Anchors

All Althon SFA Headwalls and Toes are fitted with Rapid-Lift lifting anchors. The Althon Rapid-Lift system allows the SFA Headwalls & Toes to be offloaded, transported and located in their final position without the need for any specialised lifting equipment. Standard lifting hooks and chains can be used with the three lifting points (two lifting points on Toes). The minimum chain leg length for all units is 1500mm.

## Althon Precast Concrete SFA Headwall Safety Sheet

Althon Limited manufacture pre-cast concrete SFA Headwalls using :-

**6 - 14mm aggregate · 0/4mm Sharp sand · Portland cement BS EN 197-1- Cem 1 52.5 · Cryso Fluid Premia 205 Varit Superplasticiser**

When units have been manufactured and cured they are in a chemically inert state. But the following information should be considered.

- It is advisable to wear toe cap safety footwear when handling any concrete products. Please refer to your company Safety Policy for specific details on manual handling.
- When cutting with masonry grinding discs or drilling with masonry drill bits it is necessary to wear eye protection and a dust mask. It is also recommended to wear ear protection during either of these two processes.
- Due to some units having sharp edges it is advisable to wear protective gloves when handling Althon products.
- When fitting or removing some of the larger accessories it is necessary to use a mechanical system to prevent risk of back injury.

## Maintenance of SFA Headwalls

With respect to the maintenance of any exposed surfaces of concrete components, only routine (Annual) cleaning may be necessary with a Power Washer and possibly some mild detergent to any exposed surfaces to maintain appearance; however all sites are unique and environmental impact of cleaning should be taken into account. Where cleaning is required and environmental conditions prevent mild detergent, using clean water and a power washer/stiff brush should suffice. Concrete units are often expected to “weather” and some coverage will help them to blend into their environment.

If damage to the structure of any pre-cast concrete components occurs we recommend their replacement not repair. If there is minor damage to corners during their normal life by grass cutting equipment etc. then repair with an epoxy compound such as ‘Mason Mate 0868PR380 Polyester Resin’.

To dispose of any Pre-Cast concrete components the preferred method is to recycle the material by crushing and grading, but if the quantity is too small to be cost effective then disposal in conventional landfill is acceptable as all the concrete components are inert with regard to having any environmental impact.

### **Maintenance of Galvanised Grates & Handrails.**

Annual/bi-annual visual checks are basic recommendations. If gratings are in a water course subject to a higher level of debris/weed, then more regular checks may be required. Clearing of debris/weeds from the grate will ensure no disruption to the flow, or backing up of the water course. Handrails should also only require a visual inspection – annually or at the same time as the headwall & grates.