

## H20C Headwall Range

Up to 1650mm Pipework  
1250mm - 2130mm Backwall Height

H20C Headwalls are two piece precast concrete headwall structures with rebated joints to be assembled on site around the drainage pipe and locked together by means of stainless steel cast-in sockets and brackets.

The H20C Headwall Range caters for plastic or clay pipes up to 1650mm or concrete pipes up to 1500mm. H20C Headwalls are available with three standard backwall heights 1250mm, 1650mm and 2100mm.

H20C Headwalls are available with three different wingwall profiles, sloped, horizontal and chamfered

We cast the opening in the back wall of our precast concrete headwalls to suit the pipe diameter and material of the pipe being used. We can cast multiple pipe openings, elliptical, square or rectangular culvert openings into any of our headwalls. We can also cast pipe openings into the wing walls of our headwalls.

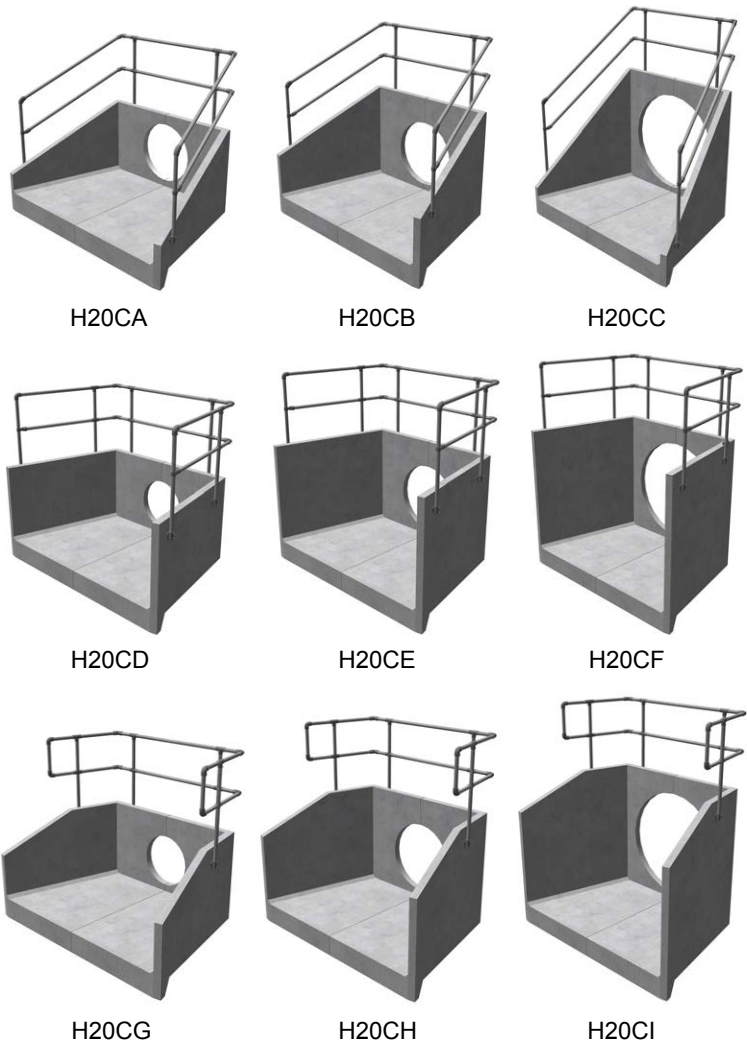

Optional Kee Klamp handrail

Headwall	Max Pipe Opening Plastic/C/ware	Max Pipe Opening PCC	A	B	Approx Weight kg
H20CA	750	750	1250	300	2600
H20CB	1050	1050	1650	700	3200
H20CC	1650	1500	2130	200	3600
H20CD	750	750	1250	1150	3100
H20CE	1050	1050	1650	1550	3700
H20CF	1650	1500	2130	2030	4100
H20CG	750	750	1250	652	2950
H20CH	1050	1050	1650	1052	3450
H20CI	1650	1500	2130	1532	3950

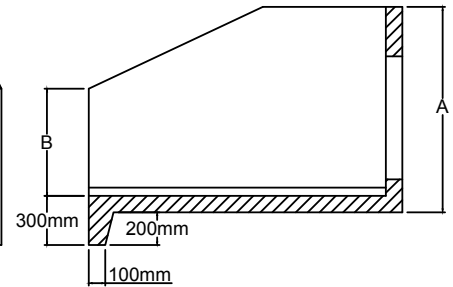
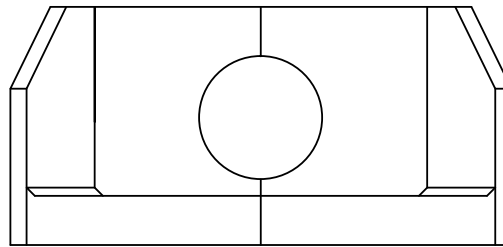
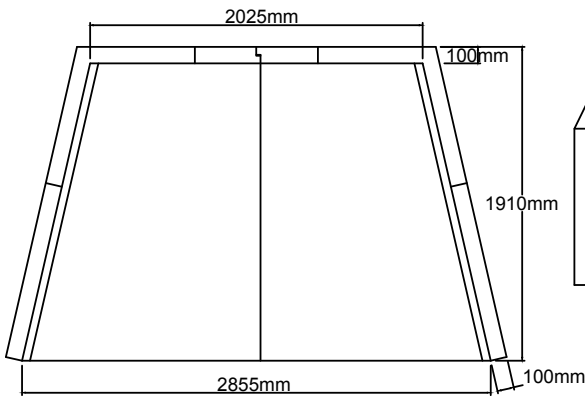
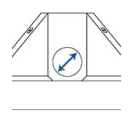
Maximum pipe size  
900mm

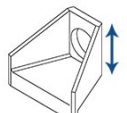

Backwall heights  
1250mm -  
2130mm

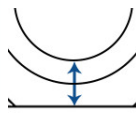

Specifiable pipe  
invert levels

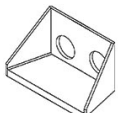

Single or multiple pipe  
openings



Optional pre-fitted  
grating

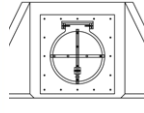

Optional pre-fitted  
flap valve

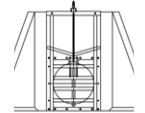

Optional pre-fitted  
penstock



## Installation Guide

Once installed correctly the ground pressure of a headwall is low (approximately 6.5kn/m<sup>2</sup>) Althon suggest a minimum sub base of 100mm dry mix concrete to give a foundation to sit the headwall onto

1. Ensure that the pipe is fully fitted leaving either the first (or last) section of pipe free from backfill in order to attach to the headwall
2. Dig out the bank of the watercourse to take the size of the headwall making sure that the headwall will not protrude into the path of the water flow
3. Dig out sufficient size trench to take the toe along the front of foundation allowing for sufficient room to manoeuvre the headwall over the end of the pipe
  - If an extended toe is to be fitted then increase the depth of the excavation as required
  - If very large pipes are being used, it is recommended that a 500mm wide x 500mm deep trench filled with mass concrete is constructed under the back edge of the headwall to cover the possibility of the heavy pipe resting upon the opening within the back wall of the headwall.
4. Lay a minimum (varies with ground conditions) of 100mm thick bed of dry mix concrete as a foundation to rest the headwall on. Althon recommend creating a slight fall of 1:50 from pipe to spill mouth
5. Prior to lifting and positioning the headwall all attachments such as gratings and water control gear should be removed
  - If there is a bolt on extended toe fully thread the M16 stainless steel studding into the fixing sockets of the toe and lift this into position first. Once the headwall is installed on top of the toe use washers and nuts to fix the headwall and toe together. Once the nuts have been sufficiently tightened fill the holes with mortar
  - Do not exceed a torque setting of 40Nmm<sup>2</sup> when tightening bolts.
6. Lift the first half of the headwall (section A) into position using 3no RD20 threaded lifting eyes, long adjustable chains and suitable machinery. Before carrying out the lifting operation all relevant personnel involved should read the installation and lifting guide in this document and a detailed lift plan and risk assessment should be completed by a competent person
  - 2no RD20 threaded lifting sockets are located in the base of the headwall with a third in the top of the wing wall
  - To prevent excessive side loading 1no RD20 Premium swivel lifting eye must be used for the lifting socket in the wing wall
  - The length of the chain attached to the wing wall must be shortened accordingly so that the headwall lifts in a level position. This may require several test lifts in order to check the lengths are correct
  - Placing a shim at the bottom of the pipe will assist with centring it in position
  - If attachments such as water control gear or gratings are to be fitted to the headwall – the pipe must be fitted flush with the inside of the back wall



- If there are no attachments to be fitted Althon recommend fitting the headwall so that the pipe protrudes 50mm through the back wall.

7. Apply an appropriate mortar/resin or mastic sealant to the joint of section A.

8. Complete the lifting operation detailed in section 7 for unit B of the headwall.

9. Connect headwalls together using angle brackets and M10 studding, one fixing point is located on the front of the toe, with a further two on the outside of the back wall.

10. To prevent bolts binding copper slip must be applied to the thread of all bolts.

11. Do not exceed a torque setting of 40Nmm<sup>2</sup> when tightening bolts.

12. When satisfied with the position backfill in front and under the headwall toe with mass concrete.

13. Backfill around the pipe with either mass concrete or well-compacted impervious clay. If concrete has been used around the pipe then proceed with soil backfilling to the top level of the structure ensuring good compaction as you go

14. Depending on soil conditions and specific site requirements Althon recommend backfilling around wing walls with well compacted impervious clay

15. Using an appropriate mortar or resin fill in the gap between the pipe and headwall around the opening in the back wall of the headwall

16. For fitting gratings and other fabricated metal components

- Position the grating using appropriate lifting equipment
- Use the correct size and length of stainless steel bolts with washers to fix
- Gratings to the threaded fixing sockets cast into headwalls
- To prevent bolts binding in threaded fixing sockets copper slip must be applied to the thread of all bolts
- Do not exceed a torque setting of 40Nmm<sup>2</sup> when tightening bolts.

17. For fitting water control gear (i.e. Flap Vales & Penstocks)

- Apply foam seal or mastic sealant to the back plate of the water control gear to ensure a watertight seal between the headwall
- Position the water control gear using appropriate lifting equipment
- Use the correct size and length of stainless steel bolts with washers to fix control gear to the threaded fixing sockets cast into headwalls
- To prevent bolts binding in threaded fixing sockets copper slip must be applied to the thread of all bolts. Do not exceed a torque setting of 40Nmm<sup>2</sup> when tightening bolts. Overtightening bolts may distort the back-plate thus preventing the valve from sealing correctly

Due to the wide variety of site conditions this is only intended to be a guide, it is inappropriate to give specific information regarding details such as the depth of foundations to support the headwall or a detailed lift plan & risk assessment.

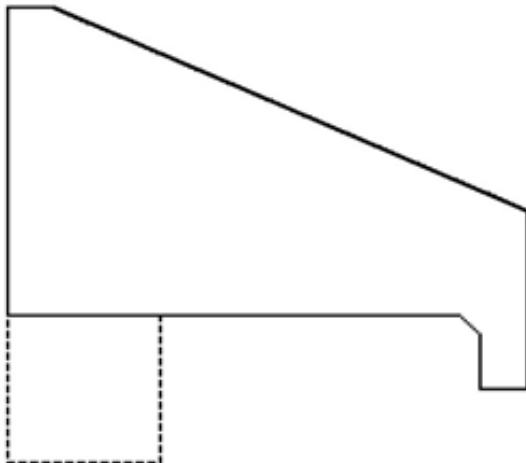

500 x 500 trench filled  
with mass concrete to  
support any pipe loading.

