

REF

SN1
P2017
(Feb)

Aluminium Sign Trays, Panels & Fingerposts



Price List

GREENBARNES LTD

ALUMINIUM SIGN TRAYS, FLAT PANELS & FINGERPOSTS

SIGN TRAYS

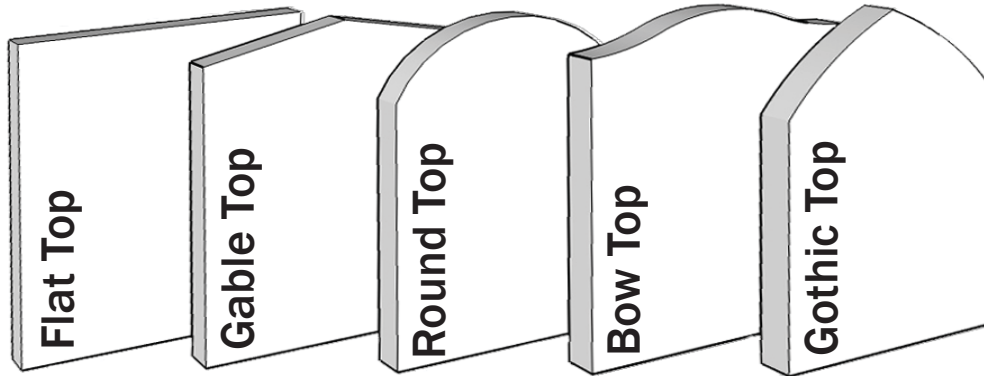

SIGN PANELS

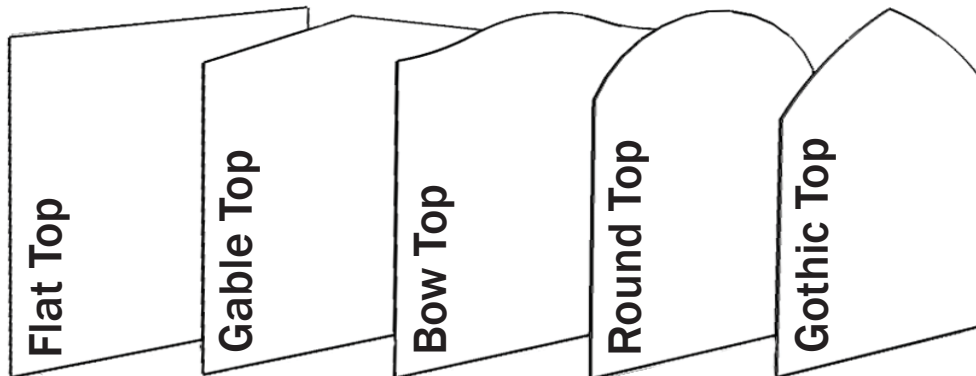

FINGERPOSTS

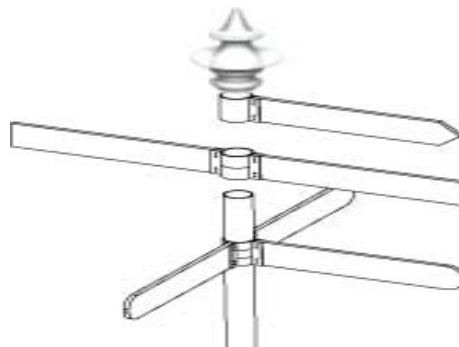

© Greenbarnes Ltd. 2017

Greenbarnes Ltd.

**Unit 7, Barrington Court, Ward Road, Buckingham Road Industrial Estate
Brackley, Northamptonshire, NN13 7LE**

T: 01280 701093 F: 01280 702843 E: sales@greenbarnes.co.uk W: www.greenbarnes.co.uk

Aluminium Sign Trays

Price List

Standard specifications:



Prices given below are for signs manufactured to our standard specification i.e. constructed in 3mm aluminium sheet with folded returns, welded corners and powder coated to a RAL colour. Post mounted versions are supplied with 76mm diameter 2500mm long posts. Wall mounted versions come with necessary fixings. All are available on a 2-4 week lead time.

Lettering is applied in computer-cut vinyl characters. Logos, crests etc can be reproduced from suitable artwork supplied by the client, and are printed onto vinyl and applied to the signs where specified.

Options:

A wide range of options are available including decorative finials, collars & base embellishers for posts, anti graffiti products, etc.

We are also able to supply completely bespoke signs to match existing furnishings and surroundings. To receive a no-obligation quotation please contact us with details of your requirements. Prices are based on supply of single items. Discounts may be available for orders of multiple trays. Please contact us for a no-obligation quotation by completing our quotation request form which can be found at http://www.greenbarnes.co.uk/wp-content/uploads/stq_web.pdf

Wall Mounted Standard 'A' Size Sign Trays			Powder coated White	Powder coated colour	Computer cut Vinyl Lettering (Price per sign)	Computer cut vinyl border (Price per sign)
			Price Ex VAT		Price Ex VAT	Price Ex VAT
STSA4W		A4 Landscape or Portrait with 25mm folded returns all round and wall fixings	£66.33	£148.15	£61.72	£25.00
STSA3W		A3 Landscape or Portrait with 25mm folded returns all round and wall fixings	£73.09	£153.24	£71.03	£25.00
STSA2W		A2 Landscape or Portrait with 25mm folded returns all round and wall fixings	£85.60	£162.42	£89.63	£25.00

Sign Trays with 50mm folded returns all round. Codes ending 'W' come with wall fixing kit, codes ending 'P' come with end Posts.				GABLE TOP		SHOULDER HEIGHT	BOW TOP		SHOULDER HEIGHT	Computer cut vinyl lettering (Price per sign)	computer cut vinyl border (Price per sign)
Width (mm)	Height (mm)	Ref Code	Price Ex VAT	mm	Ref Code	Price Ex VAT	mm	Price Ex VAT	Price Ex VAT		
600	600	STG66W STG66P	£226.54 £321.90	500	STB66W STB66P	£230.80 £326.22	500	£106.12	£25.00		
	900	STG69W STG69P	£241.02 £333.01	750	STB69W STB69P	£245.27 £337.34	750	£132.97	£25.00		
	1200	STG612W STG612P	£255.53 £351.53	1000	STB612W STB612P	£259.78 £353.98	1000	£159.82	£28.09		
	1500	STG615W STG615P	£270.02 £373.88	1250	STB615W STB615P	£274.25 £376.32	1250	£186.66	£32.77		
900	600	STG96W STG96P	£238.09 £333.01	500	STB96W STB96P	£262.33 £357.36	500	£132.97	£25.00		
	900	STG99W STG99P	£257.52 £361.11	750	STB99W STB99P	£281.76 £382.78	750	£173.24	£25.00		
	1200	STG912W STG912P	£276.98 £393.03	1000	STB912W STB912P	£301.22 £414.70	1000	£213.51	£32.77		
	1500	STG915W STG915P	£296.41 £306.85	1250	STB915W STB915P	£320.65 £446.62	1250	£253.79	£37.45		
1200	600	STG126W STG126P	£249.63 £351.53	500	STB126W STB126P	£293.89 £392.44	500	£159.82	£28.09		
	900	STG129W STG129P	£274.02 £393.03	750	STB129W STB129P	£318.27 £433.94	750	£213.51	£32.77		
	1200	STG1212W STG1212P	£298.41 £434.51	1000	STB1212W STB1212P	£342.67 £475.43	1000	£267.21	£37.45		
	1500	STG1215W STG1215P	£322.80 £476.01	1250	STB1215W STB1215P	£367.04 £516.91	1250	£320.91	£42.14		
1500	900	STG159W STG159P	£290.51 £424.95	750	STB159W STB159P	£354.76 £485.08	750	£253.79	£37.45		
	1200	STG1512W STG1512P	£319.87 £476.01	1000	STB1512W STB1512P	£384.12 £536.15	1000	£320.91	£42.14		
1800	1200	STG1812W STG1812P	£341.30 £517.50	1000	STB1812W STB1812P	£425.56 £596.87	1000	£374.61	£46.82		

ADDITIONAL INFORMATION

Sign panels & sign trays can be made to any size. If the above standard sizes are not suitable we will be happy to quote on a bespoke size. Please contact us for a no obligation quotation on any of the standard sizes or bespoke requirements.

Once an order is received we will generate a layout for your approval prior to production.

We have a variety of anti graffiti products which can be applied to the above signs. These range from spray on graffiti films to polycarbonate sheets with stand-offs. In all cases please contact us if you feel you will require additional protection to your sign.

Sign Trays with 50mm folded returns all round. Codes ending 'W' come with wall fixing kit, codes ending 'P' come with end Posts.				FLAT TOP		Shoulder Height		ROUND TOP		Shoulder Height		GOTHIC TOP		Shoulder Height		Computer cut vinyl lettering (Price per sign)	computer cut vinyl border (Price per sign)
Width (mm)	Height (mm)	Ref Code	Price Ex VAT	mm	Ref Code	Price Ex VAT	mm	Ref Code	Price Ex VAT	mm	Price Ex VAT	Price Ex VAT	Price Ex VAT				
600	600	STF66W STF66P	£176.57 £270.75	n/a	STR66W STR66P	£228.45 £326.22	300			n/a	£106.12	£25.00					
	900	STF69W STF69P	£191.67 £281.87		STR69W STR69P	£243.51 £337.34	600	STA69W STA69P	£242.34 £337.34	460	£132.97	£25.00					
	1200	STF612W STF612P	£206.73 £300.39		STR612W STR612P	£258.61 £353.98	900	STA612W STA612P	£256.82 £353.98	760	£159.82	£28.09					
	1500	STF615W STF615P	£211.22 £322.74		STR615W STR615P	£273.67 £376.32	1200	STA615W STA615P	£271.91 £376.32	1060	£186.66	£32.77					
900	600	STF96W STF96P	£197.84 £281.87	n/a			n/a			n/a	£132.97	£25.00					
	900	STF99W STF99P	£208.16 £309.97		STR99W STR99P	£278.25 £382.78	450			n/a	£173.24	£28.09					
	1200	STF912W STF912P	£228.18 £341.89		STR912W STR912P	£300.05 £414.70	750	STA912W STA912P	£295.33 £414.70	540	£213.51	£32.77					
	1500	STF915W STF915P	£241.16 £373.80		STR915W STR915P	£318.31 £446.62	1050	STA915W STA915P	£314.76 £446.62	840	£253.79	£37.45					
1200	600	STF126W STF126P	£199.66 £300.39	n/a			n/a			n/a	£159.82	£28.09					
	900	STF129W STF129P	£224.66 £341.89				n/a			n/a	£213.51	£32.77					
	1200	STF1212W STF1212P	£249.62 £383.37		STR1212W STR1212P	£337.95 £475.43	600			n/a	£267.21	£37.45					
	1500	STF1215W STF1215P	£271.07 £424.87		STR1215W STR1215P	£363.47 £517.45	900			n/a	£320.91	£42.14					
1500	900	STF159W STF159P	£241.16 £373.80	n/a			n/a			n/a	£253.79	£37.45					
	1200	STF1512W STF1512P	£271.07 £424.87				n/a			n/a	£320.91	£42.14					
1800	1200	STF1812W STF1812P	£292.51 £466.35	n/a			n/a			n/a	£374.61	£46.82					

Options for Signs

Description	Reference	Price exc. V.A.T.	Description	Reference	Price exc. V.A.T.
Ball Finial Powder coated RAL colour (each)	BF/PC	£51.18	Single Colour Logos (From artwork provided by client)	LOGO	£49.16
Gothic Finial Powder coated RAL colour (each)	GF/PC	£63.36	Full Colour Logos (From artwork provided by client)	LOGO/C	£61.38
Post Base Embellisher (each)	BASEMB/PC	£138.12			
Post decorative collar (each)	PLNCOL/PC	£19.01			

Colours (colours can be viewed at <http://www.greenbarnes.co.uk/resources/colour-charts/>)

Standard RAL colours	Standard RAL colours
RAL 9016 Traffic White RAL 9005 Jet Black RAL 5002 Ultramarine Blue RAL 5005 Signal Blue RAL 5012 Light Blue RAL 6005 Moss Green RAL 6029 Mint Green RAL 3004 Purple Red	RAL 3020 Traffic Red RAL 2008 Bright Red Orange RAL 1023 Traffic Yellow RAL 1014 Ivory RAL 8017 Chocolate Brown RALBESP Other RAL colour charge (Price on application)

Delivery by Carrier (U.K. Mainland)

	Delivery per sign up to A2 in size	£29.66
	Delivery per sign unit up to 600mm width,	£36.62
	Delivery per sign unit up to 1200mm width	£87.83
	Delivery per sign unit up to 1800mm width	£87.83
	Delivery per post, (when delivered with sign)	£9.14

Greenbarnes Ltd.

Unit 7, Barrington Court, Ward Road, Buckingham Road Industrial Estate
Brackley, Northamptonshire, NN13 7LE

T: 01280 701093 F: 01280 702843 E: sales@greenbarnes.co.uk W: www.greenbarnes.co.uk

Aluminium Sign Panels

Price List

Standard specifications:



Prices given below are for signs manufactured to our standard specification i.e. constructed in 3mm aluminium sheet with 25mm radius corners & vinyl colour to face. Post mounted versions are supplied with 76mm diameter 2500mm long posts painted grey. Wall mounted versions come with necessary fixings. All are available on a 2-4 week lead time.



Lettering is applied in computer-cut vinyl characters. Logos, crests etc can be reproduced from suitable artwork supplied by the client, and are printed onto vinyl and applied to the signs when specified.

Options:

We are also able to supply completely bespoke signs to match existing furnishings and surroundings. To receive a no-obligation quotation please contact us with details of your requirements.

Prices are based on supply of single items. Discounts may be available for orders of multiple panels. Please contact us for a no-obligation quotation by completing our quote request form which can be found at http://www.greenbarnes.co.uk/wp-content/uploads/sn3_qrf_web.pdf

Wall Mounted Standard 'A' Size Sign Panels			Vinyl colour to face only	Computer cut Vinyl Lettering (Price per sign)	Computer cut vinyl border (Price per sign)
			Price Ex VAT	Price Ex VAT	Price Ex VAT
SPSA4W		A4 Landscape or Portrait flat panel with wall fixings	£26.65	£61.72	£25.00
SPSA3W		A3 Landscape or Portrait flat panel with wall fixings	£29.65	£71.03	£25.00
SPSA2W		A2 Landscape or Portrait flat panel with wall fixings	£37.66	£89.63	£25.00

3mm Flat Sign Panels. Codes ending 'W' come with wall fixing kit, codes ending 'P' come with Rear Fix Grey Posts.					SHOULDER HEIGHT		SHOULDER HEIGHT	Computer cut vinyl lettering (Price per sign)	computer cut vinyl border (Price per sign)
Width (mm)	Height (mm)	Ref Code	Price Ex VAT	mm	Ref Code	Price Ex VAT	mm	Price Ex VAT	Price Ex VAT
600	600	SPG66W	£57.95	500	SPB66W	£101.62	500	£106.12	£25.00
		SPG66P	£175.28		SPB66P	£220.37			
	900	SPG69W	£72.00	750	SPB69W	£116.78	750	£132.97	£25.00
		SPG69P	£196.20		SPB69P	£243.10			
1200	1200	SPG612W	£89.75	1000	SPB612W	£135.64	1000	£159.82	£28.09
		SPG612P	£220.82		SPB612P	£269.53			
1500	1500	SPG615W	£107.50	1250	SPB615W	£154.50	1250	£186.66	£32.77
		SPG615P	£245.42		SPB615P	£295.96			
900	600	SPG96W	£72.00	500	SPB96W	£116.78	500	£132.97	£25.00
		SPG96P	£196.20		SPB96P	£243.10			
	900	SPG99W	£98.63	750	SPB99W	£145.08	750	£173.24	£25.00
		SPG99P	£233.12		SPB99P	£282.76			
1200	1200	SPG912W	£125.27	1000	SPB912W	£173.38	1000	£213.51	£32.77
		SPG912P	£270.04		SPB912P	£322.39			
1500	1500	SPG915W	£151.91	1250	SPB915W	£201.69	1250	£253.79	£37.45
		SPG915P	£306.97		SPB915P	£362.05			
1200	600	SPG126W	£89.75	500	SPB126W	£135.64	500	£159.82	£28.09
		SPG126P	£220.82		SPB126P	£269.53			
	900	SPG129W	£125.27	750	SPB129W	£173.38	750	£213.51	£32.77
		SPG129P	£270.04		SPB129P	£322.39			
1200	1200	SPG1212W	£160.78	1000	SPB1212W	£211.11	1000	£267.21	£37.45
		SPG1212P	£319.27		SPB1212P	£375.26			
1500	1500	SPG1215W	£196.30	1250	SPB1215W	£248.86	1250	£320.91	£42.14
		SPG1215P	£368.49		SPB1215P	£428.12			
1500	900	SPG159W	£151.91	750	SPB159W	£201.69	750	£253.79	£37.45
		SPG159P	£306.97		SPB159P	£362.05			
1200	1200	SPG1512W	£196.30	1000	SPB1512W	£248.86	1000	£320.91	£42.14
		SPG1512P	£368.49		SPB1512P	£428.12			
1800	1200	SPG1812W	£231.80	1000	SPB1812W	£286.58	1000	£374.61	£46.82
		SPG1812P	£417.74		SPB1812P	£480.99			

ADDITIONAL INFORMATION

Sign panels can be made to any size. If the above standard sizes are not suitable we will be happy to quote on a bespoke size. Please contact us for a no obligation quotation on any of the standard sizes or bespoke requirements.

Once an order is received we will generate a layout for your approval prior to production.

We have a variety of anti graffiti products which can be applied to the above signs. These range from spray on graffiti films to polycarbonate sheets with stand-offs. In all cases please contact us if you feel you will require additional protection to your sign.

3mm Flat Sign Panels. Codes ending 'W' come with wall fixing kit, codes ending 'P' come with Rear Fix Posts.				FLAT TOP		Shoulder Height		ROUND TOP		Shoulder Height		GOTHIC TOP		Shoulder Height		Computer cut vinyl lettering (Price per sign)	computer cut vinyl border (Price per sign)								
Width (mm)	Height (mm)	Ref Code	Price Ex VAT	mm	Ref Code	Price Ex VAT	mm	Ref Code	Price Ex VAT	mm	Price Ex VAT	Price Ex VAT	Price Ex VAT												
600	600	SPF66W SPF66P	£49.72 £167.05	n/a	SPR66W SPR66P	£101.62 £220.37	300	n/a	n/a	n/a	n/a	£106.12	£25.00												
	900	SPF69W SPF69P	£63.77 £187.97		SPR69W SPR69P	£116.78 £243.10	600					SPA69W SPA69P	£116.78 £243.10	460	£132.97	£25.00									
	1200	SPF612W SPF612P	£81.52 £212.59		SPR612W SPR612P	£135.64 £269.53	900					SPA612W SPA612P	£135.64 £269.53	760	£159.82	£28.09									
	1500	SPF615W SPF615P	£99.27 £237.19		SPR615W SPR615P	£154.50 £295.96	1200					SPA615W SPA615P	£154.50 £295.96	1060	£186.66	£32.77									
900	600	SPF96W SPF96P	£63.77 £187.97	n/a	n/a	n/a	n/a	n/a	n/a	n/a	n/a	£132.97	£25.00												
	900	SPF99W SPF99P	£90.41 £224.89									SPR99W SPR99P	£141.65 £282.76	450	n/a	£173.24	£25.00								
	1200	SPF912W SPF912P	£117.04 £261.82									SPR912W SPR912P	£173.38 £322.39	750		SPA912W SPA912P	£173.38 £322.39	540	£213.51	£32.77					
	1500	SPF915W SPF915P	£143.68 £298.74									SPR915W SPR915P	£201.69 £362.05	1050		SPA915W SPA915P	£201.69 £362.05	840	£253.79	£37.45					
1200	600	SPF126W SPF126P	£81.52 £212.59	n/a	n/a	n/a	n/a	n/a	n/a	n/a	n/a	£159.82	£28.09												
	900	SPF129W SPF129P	£117.04 £261.82									n/a	n/a	n/a	n/a	n/a	n/a	n/a	n/a	£213.51	£32.77				
	1200	SPF1212W SPF1212P	£152.55 £311.04																	SPR1212W SPR1212P	£211.11 £375.26	600	n/a	£267.21	£37.45
	1500	SPF1215W SPF1215P	£188.07 £360.26																	SPR1215W SPR1215P	£248.86 £428.12	900		£320.91	£42.14
1500	900	SPF159W SPF159P	£143.68 £298.74	n/a	n/a	n/a	n/a	n/a	n/a	n/a	£253.79									£37.45					
	1200	SPF1512W SPF1512P	£188.07 £360.26								£320.91	£42.14													
1800	1200	SPF1812W SPF1812P	£223.58 £409.51	n/a	n/a	n/a	n/a	n/a	n/a	n/a	n/a	£374.61	£46.82												

Vinyl Colours (colours can be viewed at <http://www.greenbarnes.co.uk/resources/colour-charts/>)

Standard Vinyl colours	Reference	Standard Vinyl colours	Reference
Light Blue	AS01	Red	AS08
Mid Blue	AS02	Light Orange	AS09
Navy Blue	AS03	Yellow	AS10
Light Green	AS04	Cream	AS11
Dark Green	AS05	Black	AS12
White	AS06	Dark Brown	AS15
Maroon	AS07	Light Grey	AS16

Gold & Silver vinyl is also available for lettering colour but not for background colour!

Delivery by Carrier (U.K. Mainland)

	Delivery per sign up to A2 size	£29.66
	Delivery per sign unit up to 600mm width,	£36.62
	Delivery per sign unit up to 1200mm width	£87.83
	Delivery per sign unit up to 1800mm width	£87.83
	Delivery per post, (when delivered with sign)	£9.14

Greenbarnes Ltd.

Unit 7, Barrington Court, Ward Road, Buckingham Road Industrial Estate

Brackley, Northamptonshire, NN13 7LE

T: 01280 701093 F: 01280 702843 E: sales@greenbarnes.co.uk W: www.greenbarnes.co.uk

FingerPost Systems

Price List

Standard specifications:

Prices given below are for fingerposts manufactured to our standard specification i.e. constructed in aluminium and supplied powder coated to a RAL colour. Multiple post, finger & finial options are all shown below & all are available on a 2-4 week lead time.



Lettering is applied in computer-cut vinyl characters. Logos, crests etc can be reproduced from suitable artwork supplied by the client, printed onto vinyl and applied to the fingers.

A wide range of options are available such as 1,2 or 3 way finger arms. Finger arms are available with chevron, square ended or bull nosed ends and up to a length of 900mm. In all cases the panels are 16mm thick & double sided. Standard 76mm posts are available as well as a decorative version with collars, base embellishers and finials.



Additionally, if necessary, we are able to supply completely bespoke boards to match existing furnishings and surroundings. To receive a no-obligation quotation please contact us with details of your requirements.

Options:



Chevron Ended Finger Arm & Socket Assembly up to 900mm

	1 Way Chevron Ended Finger Arm & Socket	Reference	Price exc. V.A.T.
		Chevron ended 1-Way finger arm 120mm height, powder coated a RAL colour Chevron ended 1-Way finger arm 165mm height, powder coated a RAL colour Chevron ended 1-Way finger arm 200mm height, powder coated a RAL colour Chevron ended 1-Way finger arm 250mm height, powder coated a RAL colour Chevron ended 1-Way finger arm 300mm height, powder coated a RAL colour	CEF120 CEF165 CEF200 CEF250 CEF300
	2 Way Chevron Ended Finger Arms & Sockets		
	Chevron ended 2-Way finger arm 120mm height, powder coated a RAL colour Chevron ended 2-Way finger arm 165mm height, powder coated a RAL colour Chevron ended 2-Way finger arm 200mm height, powder coated a RAL colour Chevron ended 2-Way finger arm 250mm height, powder coated a RAL colour Chevron ended 2-Way finger arm 300mm height, powder coated a RAL colour	CEF2W120 CEF2W165 CEF2W200 CEF2W250 CEF2W300	£180.56 £196.29 £221.24 £230.67 £254.46
	3 Way Chevron Ended Finger Arms & Sockets		
	Chevron ended 3-Way finger arm 120mm height, powder coated a RAL colour Chevron ended 3-Way finger arm 165mm height, powder coated a RAL colour Chevron ended 3-Way finger arm 200mm height, powder coated a RAL colour	CEF3W120 CEF3W165 CEF3W200	£252.98 £276.30 £317.79







Square Ended Finger Arm & Socket Assembly up to 900mm

	1 Way Square Ended Finger Arm & Socket	Reference	Price exc. V.A.T.
		Square ended 1-Way finger arm 120mm height, powder coated a RAL colour Square ended 1-Way finger arm 165mm height, powder coated a RAL colour Square ended 1-Way finger arm 200mm height, powder coated a RAL colour Square ended 1-Way finger arm 250mm height, powder coated a RAL colour Square ended 1-Way finger arm 300mm height, powder coated a RAL colour	SEF120 SEF165 SEF200 SEF250 SEF300
	2 Way Square Ended Finger Arms & Sockets		
	Square ended 2-Way finger arm 120mm height, powder coated a RAL colour Square ended 2-Way finger arm 165mm height, powder coated a RAL colour Square ended 2-Way finger arm 200mm height, powder coated a RAL colour Square ended 2-Way finger arm 250mm height, powder coated a RAL colour Square ended 2-Way finger arm 300mm height, powder coated a RAL colour	SEF2W120 SEF2W165 SEF2W200 SEF2W250 SEF2W300	£169.20 £189.57 £217.77 £230.67 £254.46
	3 Way Square Ended Fingers Arms & Sockets		
	Square ended 3-Way finger arm 120mm height, powder coated a RAL colour Square ended 3-Way finger arm 165mm height, powder coated a RAL colour Square ended 3-Way finger arm 200mm height, powder coated a RAL colour	SEF3W120 SEF3W165 SEF3W200	£245.31 £276.30 £317.79

Bull Nosed Finger Arm & Socket Assembly up to 900mm

	1 Way Bull Nose Ended Finger Arm & Scket	Reference	Price exc. V.A.T.
		Bull Nose ended 1-Way finger arm 120mm height, powder coated a RAL colour Bull Nose ended 1-Way finger arm 165mm height, powder coated a RAL colour Bull Nose ended 1-Way finger arm 200mm height, powder coated a RAL colour Bull Nose ended 1-Way finger arm 250mm height, powder coated a RAL colour Bull Nose ended 1-Way finger arm 300mm height, powder coated a RAL colour	BNEF120 BNEF165 BNEF200 BNEF250 BNEF300
	2 Way Bull Nose Ended Finger Arm & Socket		
	Bull Nose ended 2-Way finger arm 120mm height, powder coated a RAL colour Bull Nose ended 2-Way finger arm 165mm height, powder coated a RAL colour Bull Nose ended 2-Way finger arm 200mm height, powder coated a RAL colour Bull Nose ended 2-Way finger arm 250mm height, powder coated a RAL colour Bull Nose ended 2-Way finger arm 300mm height, powder coated a RAL colour	BNEF2W120 BNEF2W165 BNEF2W200 BNEF2W250 BNEF2W300	£231.23 £251.25 £283.19 £295.26 £325.71
	3 Way Bull Nose Ended Finger Arm & Socket		
	Bull Nose ended 3-Way finger arm 120mm height, powder coated a RAL colour Bull Nose ended 3-Way finger arm 165mm height, powder coated a RAL colour Bull Nose ended 3-Way finger arm 200mm height, powder coated a RAL colour	BNEF3W120 BNEF3W165 BNEF3W200	£317.25 £347.39 £388.20

Round Posts & Caps			
 STANDARD POST	Posts	Reference	Price exc. V.A.T.
	76mm diameter posts 1500mm long in plain finish-powder coated a RAL colour 76mm diameter posts 2000mm long in plain finish-powder coated a RAL colour 76mm diameter posts 3000mm long in plain finish-powder coated a RAL colour 76mm diameter posts 3500mm long in plain finish-powder coated a RAL colour (These lengths can be cut to specified length if required, see page 3 for drawings of post options)	AP76D15/PC £56.13 AP76D20/PC £56.88 AP76D30/PC £78.21 AP76D35/PC £83.76	

Decorative Items Including Finials & Embellishments			
 Standard Ball  Ribbed Ball  Stem Ball  Pagoda  Hollow Ring  Collars and Base Embellisher	Finials for 76mm diameter posts	Reference	Price exc. V.A.T.
	Standard Ball Finial-powder coated RAL colour	STBALL/PC	£65.78
	Ribbed Ball Finial-powder coated RAL colour	RIBBALL/PC	£65.78
	Stem Ball Finial-powder coated RAL colour	STMBALL/PC	£74.33
	Pagoda Finial-powder coated RAL colour	PAGOFIN/PC	£100.41
	Ring Finials for 76mm diameter posts		
	Small hollow-powder coated RAL colour, o/a sizes 250mm diameter x 350mm height Medium Hollow-Powder coated RAL colour, o/a sizes 350mm diameter x 420mm height Medium Solid-powder coated RAL colour, o/a sizes 350mm diameter x 420mm height	RINGFINS/PC RINGFINM/PC RINFINMS/PC	£109.88 £115.92 £115.92
	Embellishments for 76mm diameter posts		
	Plain collar-powder coated RAL colour	PLNCOL/PC	£19.01
	Flared collar-powder coated RAL colour	FLACOL/PC	£40.28
Base Embellishment-powder coated RAL colour	BASEMB/PC	£138.12	

Lettering, Logos and Colour Options for all Fingers					
Description & Overall Size (W x H)	Reference	Price exc. V.A.T.	Standard RAL colours	Reference	Price exc. V.A.T.
Vinyl Text (per character double sided, white gold or black)	SLFDS	£2.34	RAL 9016 White (satin)	RAL9016	£0.00
Vinyl Text (per character single side, white, gold or black)	SLF	£3.12	RAL 9005 Black (satin)	RAL9005	£0.00
Logo, Single Colour in computer-cut vinyl (per logo)	LOGO	£49.16	RAL 9006 Silver (satin)	RAL9006	£0.00
Logo, Full Colour in computer-cut vinyl (per logo)	LOGO/C	£61.38	RAL 1023 Yellow (satin)	RAL1023	£0.00
Vinyl border to finger (double sided) per finger	SLF/LINE	£37.45	RAL 3020 Red (satin)	RAL3020	£0.00
			RAL 3004 Maroon (satin)	RAL3004	£0.00
			RAL 8017 Brown (satin)	RAL8017	£0.00
			RAL6005 Moss Green (satin)	RAL6005	£0.00
			RAL6029 Mint Green (satin)	RAL6029	£0.00
			RAL5002 Ultramarine Blue (satin)	RAL5002	£0.00
			RAL 5010 Gentian Blue (satin)	RAL5010	£0.00
			Any other RAL colour not above (additional charge)	RALBES	£60.00

Delivery by Carrier (U.K. Mainland)		
	Delivery per fingerpost assembly,	£37.06

Greenbarnes Ltd.
Unit 7, Barrington Court, Ward Road, Buckingham Road Industrial Estate
Brackley, Northamptonshire, NN13 7LE
T: 01280 701093 F: 01280 702843 E: sales@greenbarnes.co.uk W: www.greenbarnes.co.uk

FingerPost Systems

Technical Drawings

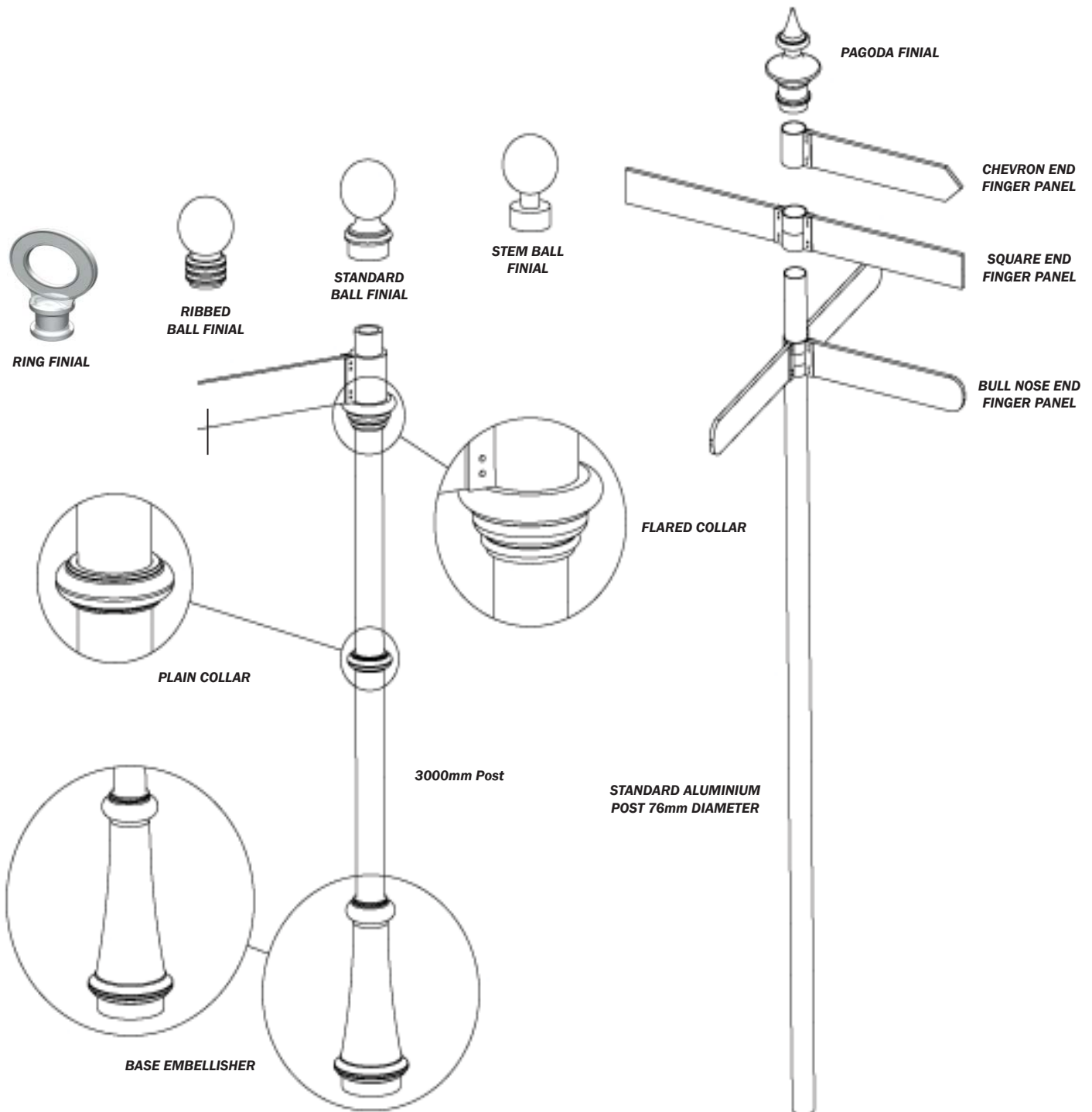

Finger panels can be arranged in any direction by simply rotating through 360 before locking in place.



Greenbarnes Ltd.

**Unit 7, Barrington Court, Ward Road, Buckingham Road Industrial Estate
Brackley, Northamptonshire, NN13 7LE**

T: 01280 701093 F: 01280 702843 E: sales@greenbarnes.co.uk W: www.greenbarnes.co.uk