

// **NEW: 2-colour entrance door styles
with colour embellishments**



Aluminium Entrance Doors

Enjoy convenience and security for your home



The best choice for your home
Hörmann aluminium entrance doors



All Hörmann entrance door styles at a glance



40 TP
Page 25



45 TP/TC
Page 15



62 TP/TC
Page 14



65 TP/TC
Page 17



75 TP/TC
Page 14



110 TP/TC
Page 16



136 TP/TC
Page 17



177 TP/TC
Page 17

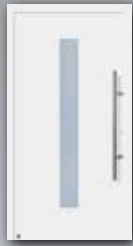

185 TP/TC
Page 16



188 TP/TC
Page 34



402 TP/TC
Page 22



413 TP/TC
Page 22



449 TP/TC
Page 22



551 TP/TC
Page 25



555 TP/TC
Page 31



556 TP/TC
Page 31



557 TP/TC
Page 31



558 TP/TC
Page 31



559 TP/TC
Page 15



560 TP/TC
Page 15



579 TP
Page 25
// NEW



650-4 TP/TC
Page 16
// NEW



659 TP/TC
Page 23



667 TP/TC
Page 23



675 TP/TC
Page 15



680 TP/TC
Page 14



686 TP/TC
Page 17



689 TP/TC
Page 23



860 TP/TC
Page 15



861 TP
Page 32



866 TP/TC
Page 17



221 TP/TC
Page 24



222 TP/TC
Page 24



223 TP/TC
Page 24



224 TP/TC
Page 24

- Traffic white RAL 9016
- Hörmann colour CH 703 (only as TP)
- Decograin Golden Oak (only as TP)

The individual Vario programme



140 TP/TC
Page 16



166 TP/TC
Page 17



173 TP/TC
Page 34



552 TP
Page 25



553 TP/TC
Page 31



554 TP
Page 31



581 TP
Page 25
// NEW



582 TP
Page 25
// NEW



650 TP/TC
Page 16



693 TP/TC
Page 32



694 TP/TC
Page 15



697 TP/TC
Page 23



225 TP/TC
Page 24

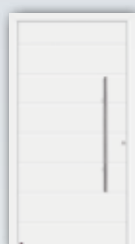

825/845/855 TP
Page 33



875/895/898 TP
Page 33



100
Page 35



101
Page 35



565 TP/TPP
Page 29



566 TP/TPP
Page 29



567 TP/TPP
Page 29



568 TP/TPP
Page 27



569 TP/TPP
Page 27



570 TP/TPP
Page 27



571 TP/TPP
Page 27



572 TP/TPP
Page 27



583 TP/TPP
Page 21
// NEW



585 TP/TPP
Page 19
// NEW



586 TP/TPP
Page 21
// NEW



587 TP/TPP
Page 21
// NEW



588 TP/TPP
Page 21
// NEW



589 TP/TPP
Page 21
// NEW



590 TP/TPP
Page 21
// NEW



591 TP/TPP
Page 19
// NEW



592 TP/TPP
Page 19
// NEW



593 TP/TPP
Page 19
// NEW



594 TP/TPP
Page 19
// NEW



595 TP/TPP
Page 19
// NEW

Versions:
 TC TopComfort (see page 8)
 TP TopPrestige (see page 9)
 TPP TopPrestigePlus (see page 10)

Experience Hörmann quality

for all applications in new buildings and modernisation projects

Garage doors

Optimally match your personal architectural style:
up-and-over or sectional doors made of steel, timber or grp.

Door operators

Enjoy extra convenience and break-in resistant security:
Hörmann operators for garage doors and entrance gates.

Entrance doors

You can find just the right door in our comprehensive
aluminium entrance door ranges, with a model to fit almost
every need and requirement.

Steel doors

Sturdy doors for your whole home, from basement to roof.

Frames

Choose from our comprehensive range of products for new
construction, expansion, and modernisation.



www.hormann.co.uk

All rights reserved. No part may be reproduced without our
prior permission. Subject to changes.

“A good reputation must be earned”.

(August Hörmann)

In keeping with the tradition started by the company's founder, the name Hörmann delivers brand name quality with extensive expertise. The family business has over 75 years of experience as a construction component specialist and sees itself as your partner from the very beginning of building and renovation projects. After all, Hörmann is one of Europe's most successful entrance door providers. All of this gives you a good feeling when you purchase a Hörmann entrance door.

Made in Germany

All entrance door components are developed and produced in-house at Hörmann. The in-house profile system and style panels, which are also designed and produced in-house, ensure that you receive an optimally matched, individual entrance door. In addition, our highly qualified employees work intensively on new products, continual further developments and improvements to details. Patents and unique products on the market are the result of this. Quality you can depend on: tests under real conditions ensure mature series products with the reliable Hörmann quality.

Certified brand quality

CE mark in accordance to EN 14351-1

The CE mark confirms compliance with and observance of the principal requirements of the EC directives according to EN 14351-1 for all of our entrance doors.

Quality assurance system according to DIN ISO 9001

Hörmann entrance door production is DIN ISO 9001 certified. This is another proof of Hörmann's motto “Quality without compromise”.

Long-lasting. Guaranteed.

We are convinced of our products and our uncompromised quality assurance. That is why we issue a 10-year guarantee* on all Hörmann entrance doors.

* The complete warranty conditions can be found under: www.hoermann.com



Design overview	3
Your advantages	7
Versions	8
Security	12
Door styles	14
Entrance doors and garage doors matched to each other	32
Design programme for entrance doors and garage doors	34
Transom doors and letter boxes	35
Canopies	36
Colours	37
Security packages	38
Glass	40
Handles	42

The Vario programme

All shown Hörmann entrance doors are also available in the highly thermal insulating and elegant **TopPrestige** version. In addition, you can design all entrance door styles based on your own ideas – with optional handles and glazing or in one of 11 preferred colours and in RAL to choose. The Vario programme also offers exclusive entrance door styles with designer handles or colour applications. This gives your entrance door a very personal touch.

For more information on aluminium entrance doors and other Hörmann quality products, visit www.hoermann.co.uk

The colours and surface finishes shown are subject to the limitations of the printing process and cannot be regarded as binding.

All rights reserved. No part may be reproduced without our prior permission. Subject to changes.

**A home should be beautiful, warm and safe
Hörmann entrance doors offer you all that**



Choose according to your own wishes from 3 different versions to receive an individual look and thermal insulation: The inexpensive basic version TopComfort, the elegant leaf-overlapping version TopPrestige, or the TopPrestigePlus version with additional thermal insulation and design. No matter which version you choose – you will always receive top quality "Made in Germany".



Your advantage: Aluminium entrance doors

You will soon notice that aluminium doors are superior to plastic and timber doors in many ways. Other than the many technical equipment and design options, you can enjoy a number of additional advantages:

- High acoustic insulation,
- High thermal insulation
- High security
- High stability
- No follow-up painting necessary, even after many years of service the doors look as good as new.

Your advantage: Thermal insulation

All Hörmann aluminium entrance doors have high thermal insulation by means of their aluminium profile systems with thermal breaks and thus comply with the current energy savings regulation. This is confirmed by the low U values that we include individually with the order confirmation for every door. For all entrance door versions you can optionally receive the thermal insulation package with additional PU foam filling in the frame and additional seal in the door rebate. TopPrestigePlus doors are distinguished by the highest thermal insulation and are especially suited for fitting into **energy-efficient houses**. See **page 10** for more information.



Your advantage: WK 2 security equipment

Hörmann entrance doors are now even more secure – with the WK 2 optional security equipment available at a surcharge.

Your advantage: Preferred colours

All Hörmann entrance doors are available in **11 equally-priced preferred colours**. More information on this can be found on **page 37**.



Your advantage: side elements and transom lights

To increase the brightness of your entrance area, all doors are available with side elements and transom lights. For many door styles you can also choose design glass side elements that were especially created to match the door style.

TopComfort entrance doors

The inexpensive standard version



TopComfort doors offer you equal degrees of design and functionality – the all-round profiles are precisely connected and mitred at the edges, creating a harmonic frame around the styled infill, which is precisely framed by the leaf profile (1). The view of the interior shows the door infill with rounded beads and the trim with a discreet grey seal (2).



Good thermal insulation

The 80-mm-thick profile system with thermal break and the 30-mm-thick infill ensure good thermal insulation. TopComfort entrance doors feature a U-value of up to 1.4 W/m² K, depending

on the style selected. This helps you save heating costs and keep your home warm and cosy.

Double thermal insulation glazing

Even with entrance door styles featuring large glazed areas you do not have to fear excessive energy loss. This is because the standard thermal insulation glazing offers you a compelling U-value as low as 1.1 W/m² K.

Optimally fitted

The beautifully designed three-way hinges allow the TopComfort entrance door to be variably adjusted. This way, your entrance door is optimally sealed and falls smoothly and securely into its lock.



TopComfort with three-way adjustable hinges. Optionally available with concealed hinges.



External view

Viewed from inside



TopPrestige entrance doors

The elegant leaf-overlapping version



External view

Viewed from inside

In the TopPrestige version, the infill design is mounted onto the leaf profile, thus appearing generous and elegant when viewed from the outside (1). Inside, it has a pleasing slim leaf profile without strips and without a visible seal (2).



External view



Viewed from inside

High thermal insulation

The glued composite construction of leaf and style infill of the TopPrestige versions offers you an entrance door with very high thermal insulation. Its thermal break profile system and the PU-foamed infill ensure that barely any heat escapes to the outside. Depending on the style, we offer you TopPrestige entrance doors with a U-value as low as 1.3 W/m² K.

Double thermal insulation glazing

With the TopPrestige entrance doors with large glazed areas, we offer you a version with the highest thermal insulation ratings. They give you the benefit of thermal insulation glazing as standard with a U-value of up to 1.1 W/m² K.

Created for comfort

The beautifully designed three-way hinges allow the TopPrestige entrance door to be variably adjusted. This way, you can always rely on the fact that your entrance door is optimally sealed and falls smoothly and securely into its lock.



Section view of TopPrestige



TopPrestige with three-way adjustable hinges. Optionally available with concealed hinges.

TopPrestigePlus entrance doors

For additional thermal insulation and design

The premium entrance door:
best thermal insulation and design



TopPrestigePlus entrance doors offer you comfort at the highest level. This is because TopPrestigePlus versions are distinguished by an infill that overlaps the leaf on the outside (1) and inside (2). The flush-fitting interior door view is particularly well matched to your interior doors.



Benefit from thermal insulation that sets new standards.

TopPrestigePlus entrance doors feature an 80 mm thick profile system with thermal break and a 70 mm thick insulated style infill. With thermal insulation

values of up to $1.1 \text{ W/m}^2\text{K}$, they are especially suited for fitting into energy-efficient houses.

For your additional comfort: triple thermal insulation glazing

Enjoy the triple glazing with a U-value as low as $0.7 \text{ W/m}^2 \text{ K}$. The resulting minimum thermal loss translates into true energy and financial savings for you.

Standard: concealed hinges

The hinges are concealed in the TopPrestigePlus version, i.e. they cannot be seen from the inside or outside - an elegant solution for your home. The door leaves can be simply and easily adjusted. This way, you can close your entrance door comfortably and securely at all times.



External view

Viewed from inside

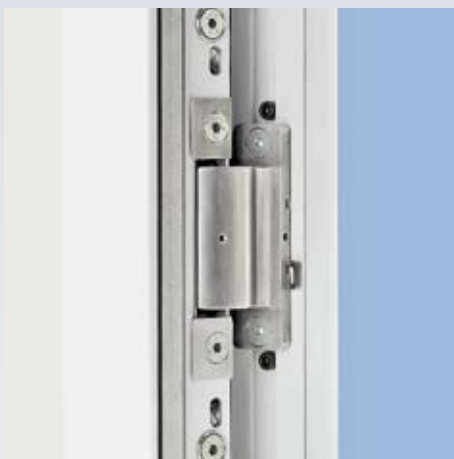

Concealed hinges as standard in TopPrestigePlus entrance doors.

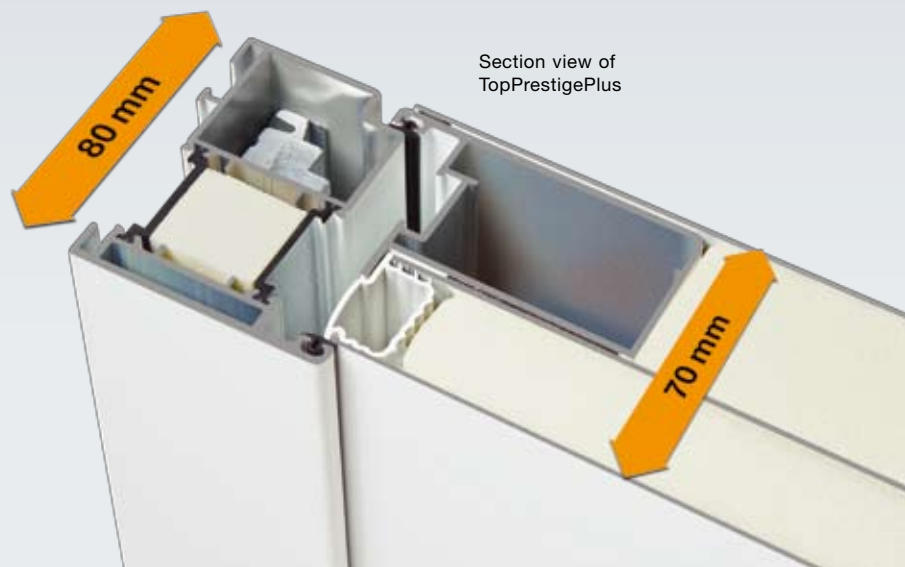

Frame profiles

In addition to the standard frame profile, you can optionally choose from two decorative fascia frame versions



Frame profile Standard 70

The standard frame profile constitutes an almost flush surface with the door infill. Optionally, it is also available with a width of 110 mm, e.g. for fitting behind the opening.



Fascia frame Rondo 70

The rounded frame profile adds a stylish touch to your entrance door, providing it with a particularly harmonious look with its rounded edges. The fascia frame Rondo 70 is available as standard with the entrance doors in Decograin Golden Oak.

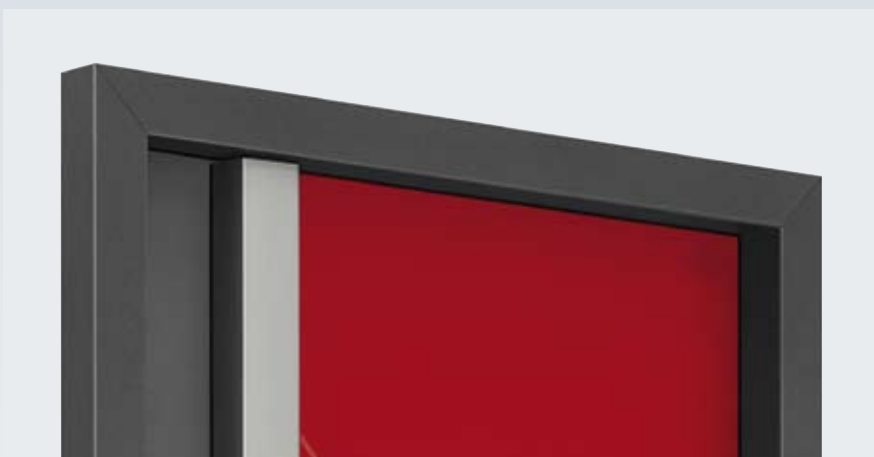

Fascia frame Careo 70 //NEW

This version has an attractive and distinguished look that upgrades the appearance of your door through the added depth appearance of the frame. For the door styles with Design handles this type of profile underlines the flush fit of the handle and the frame.

Better to play it safe

Hörmann entrance doors are an excellent choice up to the most minute detail



5-point automatic lock with automatic locking as standard

The H-5 automatic lock is a mechanical, self-locking multiple lock. The lock engages as soon as the entrance door is pushed into the latch. When locking, 3 steel hooks with 2 additional bolts pivot into the stainless steel lock plates to automatically lock the door. This self-lock function can be switched off. In addition, a stainless steel bolt on the hinge side engages with the fascia frame. To open the door, either use the lever handle or open it with a key.

Further options: child safety/holiday function, where the door is double locked with the key. The lever handle does not function anymore, so the lock can no longer be opened with it.

Variably adjustable: Hörmann door strikes (optional)

The electric door strike catch in the lock plate ensures that your guests can only enter your home if you push the electric door strike inside. During the daytime, and if the self-locking function of the H-5 automatic lock is off, you can also toggle the locking lever so that the entrance door can be opened by a slight push from the outside.



Switch lever to optionally switch off the automatic self-locking function. This makes it possible to open the door using a Hörmann electric door strike.



Solid security bolt
A stainless steel bolt engages during locking with the fascia frame. This way, it protects the door on the hinge side from being leveraged or pushed in.

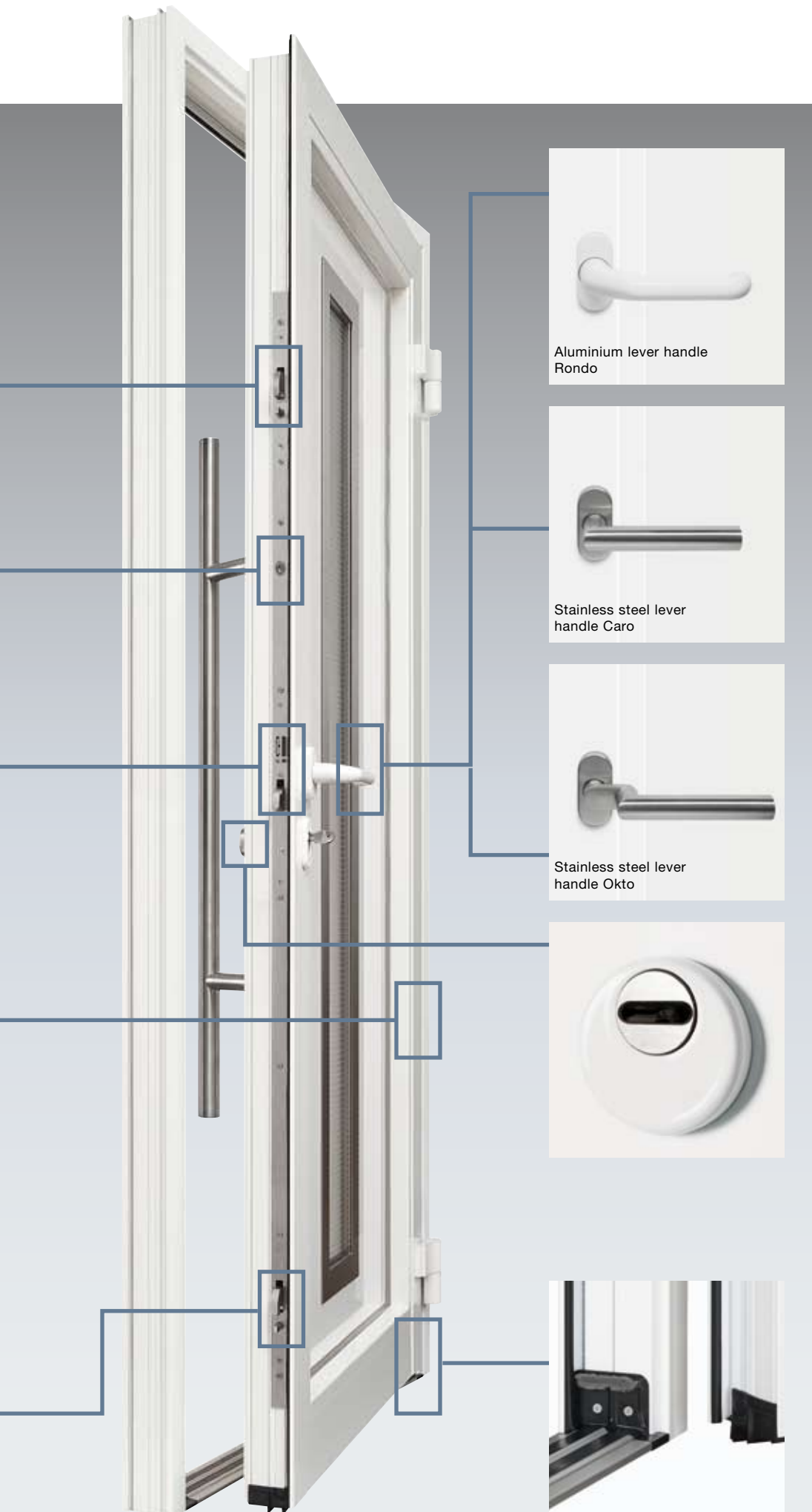

Beautifully shaped interior lever

As standard, all doors are equipped with the interior lever Rondo, stove-enamelled in white. Optionally, it is also available in stainless steel or your choice of RAL as well as the versions Caro or Okto, also in stainless steel.



Aluminium lever handle Rondo



Stainless steel lever handle Caro



Stainless steel lever handle Okto

Beautifully shaped security rose escutcheon

These protect the profile cylinder from being drilled open and twisted off. Available as standard in Traffic white RAL 9016 or in stainless steel for the surface finishes Decograin Golden Oak and Anthracite in stainless steel.



Threshold with thermal break

Extremely robust, 80 mm thick and offering thermal insulation – the entrance door threshold with thermal break and concealed bolting to the bottom. In EV1 silver coloured.



Discover your new entrance door

And a programme that offers you a lot of options



▲ **Style 680** TopPrestige in the preferred colour Window grey RAL 7040, with side elements (optional).



Style 680 TopPrestige in Traffic white RAL 9016.



Style 62 TopPrestige in Traffic white RAL 9016.



Style 75 TopPrestige in Traffic white RAL 9016.



Style 45 TopPrestige in Traffic white RAL 9016.



Style 860 TopPrestige in Traffic white RAL 9016.



Style 675 TopPrestige in Traffic white RAL 9016, with fascia frame Rondo 70 (optional).



Style 694 TopPrestige in Traffic white RAL 9016.



Style 559 TopPrestige in Traffic white RAL 9016, with fascia frame Rondo 70 (optional).



Style 560 TopPrestige in Traffic white RAL 9016, with fascia frame Rondo 70 (optional).



▲ **Style 45-5** TopPrestige in the Hörmann colour CH 703, with side elements 45-5 MG (optional).



▲ **Style 860** TopPrestige in Hörmann colour CH 703, with side element (optional).

Updated look

A new entrance door upgrades your home



▲ **Style 650** TopPrestige in Traffic white RAL 9016, with side element (optional).



Style 185 TopPrestige in Traffic white RAL 9016.



Style 650 TopPrestige in Traffic white RAL 9016, with fascia frame Rondo 70 (optional).



// NEW

Style 650-4 TopPrestige in Traffic white RAL 9016, with fascia frame Rondo 70 (optional).



Style 110 TopPrestige in Traffic white RAL 9016, with fascia frame Rondo 70 (optional).



Style 140 TopPrestige in Traffic white RAL 9016, with fascia frame Rondo 70 (optional).



Style 136 TopPrestige in Traffic white RAL 9016, with fascia frame Rondo 70 (optional).



Style 166 TopPrestige in Traffic white RAL 9016, with fascia frame Rondo 70 (optional).



Style 65 TopPrestige in Traffic white RAL 9016.



Style 177 TopPrestige in Traffic white RAL 9016.



Style 686 TopPrestige in Traffic white RAL 9016.



Style 866 TopPrestige in Traffic white RAL 9016.



▲ **Style 65** TopPrestige in Decograin surface Golden Oak, with side element 65 MG Golden Oak.



▲ **Style 686** TopPrestige in the preferred colour Window grey RAL 7040, with side elements (optional).

The entrance door as an eye-catcher

With contrasting colours and straight shapes



▲ **Style 585** in Hörmann colour CH 607 and colour embellishment in Light ivory RAL 1015, with side element (optional).



// NEW

Style 585 TopPrestige in Traffic white RAL 9016, and colour embellishment in Graphite black RAL 9011.



// NEW

Style 592 TopPrestige in Traffic white RAL 9016, and colour embellishment in Graphite black RAL 9011.



// NEW

Style 595 TopPrestige in Traffic white RAL 9016, and colour embellishment in Graphite black RAL 9011.



// NEW

Style 593 TopPrestige in Traffic white RAL 9016 and colour embellishment in Graphite black RAL 9011.



// NEW

Style 594 TopPrestige in Traffic white RAL 9016, and colour embellishment in Graphite black RAL 9011.

A different colour has a different effect



// NEW

Style 591 TopPrestige in Traffic white RAL 9016, and colour embellishment in Graphite black RAL 9011.



// NEW

Style 591 TopPrestige in preferred colour White aluminium RAL 9006 and colour embellishment in Anthracite grey RAL 7016.



▲ **Style 591** TopPrestige in Hörmann colour CH 703 and colour embellishment in Ruby red RAL 3003.

Powerful colour combinations

For your individual look





// NEW

Style 586 TopPrestige in Traffic white RAL 9016, and colour embellishment in Graphite black RAL 9011.



// NEW

Style 587 TopPrestige in Traffic white RAL 9016, and colour embellishment in Graphite black RAL 9011.

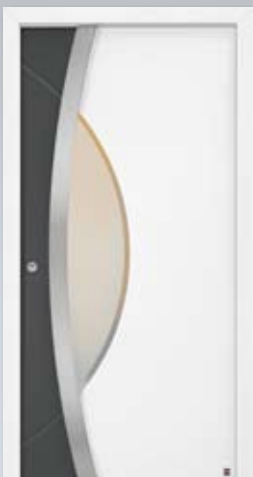

// NEW

Style 583 TopPrestige in Traffic white RAL 9016, and colour embellishment in Graphite black RAL 9011.



// NEW

Style 589 TopPrestige in Traffic white RAL 9016, and colour embellishment in Graphite black RAL 9011.

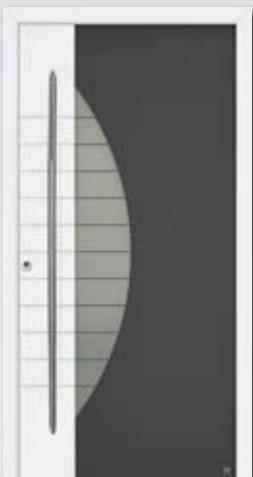

// NEW

Style 588 TopPrestige in Traffic white RAL 9016, and colour embellishment in Graphite black RAL 9011.



// NEW

Style 590 TopPrestige in Traffic white RAL 9016, and colour embellishment in Graphite black RAL 9011.



▲ Glass handle 870 for style 586

▼ HÖ 153 stainless steel handle for style 586



◀ **Style 586** TopPrestige in Hörmann colour CH 703 and colour embellishment in Salmon pink RAL 3022, with side elements (optional).

For the comfort of young and old

A Hörmann entrance door is secure and looks good



▲ **Style 449** TopPrestige in Traffic white RAL 9016.



Style 449 TopPrestige in Traffic white RAL 9016.



Style 402 TopPrestige in Traffic white RAL 9016.



Puts a sparkle in your eye
Discover the elegant combination of partially sand-blasted and fluted glass. The particularly attractive appearance and classic look are certain to convince you.



Style 413 TopPrestige in Traffic white RAL 9016.



Style 697 TopPrestige in Traffic white RAL 9016, with fascia frame Rondo 70 (optional).



Style 667 TopPrestige in Traffic white RAL 9016, with fascia frame Rondo 70 (optional).



Style 659 TopPrestige in Traffic white RAL 9016.



Style 689 TopPrestige in Traffic white RAL 9016.

▲ **Style 659** TopPrestige in preferred colour Anthracite RAL 7016, with side elements 659 MG (optional).



▲ **Style 667** TopPrestige in Traffic white RAL 9016, with side elements 667 MG (optional).

Glass for an individual touch

Looks beautiful and lets light into the house



▲ **Style 224** TopComfort in Hörmann colour CH 703, with side element (optional).



Style 221 TopComfort in Traffic white RAL 9016.



Style 222 TopComfort in Traffic white RAL 9016.



Style 223 TopComfort in Traffic white RAL 9016.



Style 224 TopComfort in Traffic white RAL 9016.



Style 225 TopComfort in Traffic white RAL 9016.



Style 551 TopPrestige in Traffic white RAL 9016, with fascia frame Rondo 70 (optional).



Style 40 TopPrestige in Traffic white RAL 9016, with fascia frame Rondo 70 (optional).

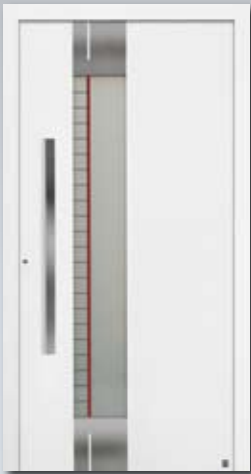

// NEW

Style 581 TopPrestige in Traffic white RAL 9016.



Style 552 TopPrestige in Traffic white RAL 9016, with fascia frame Rondo 70 (optional).



// NEW

Style 579 TopPrestige in Traffic white RAL 9016, with fascia frame Rondo 70 (optional).



// NEW

Style 582 TopPrestige in Traffic white RAL 9016, with fascia frame Rondo 70 (optional).



▲ **Style 551** TopPrestige in the preferred colour Moss green RAL 6005, with side elements (optional).



▲ **Style 581** TopPrestige in Hörmann colour CH 703, with side element (optional).

The exclusive line of Design handles

Entrance doors with perfectly matched Design handles



Persuasive elegance: Design handles in 3 colours and in RAL to choose

Our line of Design handles includes a total of eight entrance door styles, each with a perfectly matched, door-high Design handle. You have a choice of 5 styles with **Design handles** and 3 styles with **DesignPlus handles** for even more design possibilities. They are not only convenient, but also look very elegant.



Handle in Traffic white RAL 9016.



Handle in aluminium EV1.



Handle in Hörmann colour CH 703



Handle in RAL to choose.
(Shown in Ruby red RAL 3003)



Style 568 TopPrestige in Traffic white RAL 9016, with fascia frame Rondo 70 (optional).



Style 569 TopPrestige in Traffic white RAL 9016, with fascia frame Rondo 70 (optional).



Style 570 TopPrestige in Traffic white RAL 9016, with fascia frame Rondo 70 (optional).



▲ **Style 569** TopPrestige in Hörmann colour CH 703, handle in EV1, with side element and fascia frame Rondo 70 (optional).



Style 571 TopPrestige in Traffic white RAL 9016, with fascia frame Rondo 70 (optional).



Style 572 TopPrestige in Traffic white RAL 9016, with fascia frame Caro 70 (optional).

The individual DesignPlus handle series

With additional handle embellishment

Individual style: DesignPlus handles



Handle in Traffic white RAL 9016, handle embellishment in Hörmann colour CH 703.



Handle embellishment in aluminium EV1, handle in Hörmann colour CH 703.



Handle in Hörmann colour CH 703, handle embellishment in Hörmann colour CH 703.



Handle in RAL to choose (shown in Ruby red RAL 3003), handle embellishment in Hörmann colour CH 703.

Variable handle embellishments for additional design options



Handle embellishment in Traffic white RAL 9016, handle in Hörmann colour CH 703.



Handle embellishment in aluminium EV1, handle in Hörmann colour CH 703.



Handle embellishment in Hörmann colour CH 703, handle in Hörmann colour CH 703.



Handle embellishment in RAL to choose (shown in Ruby red RAL 3003), handle in CH 703



Handle embellishment in Decograin Night Oak **//NEW** intensive dark oak design, handle in Hörmann colour CH 703.



Handle embellishment in Decograin Dark Oak **//NEW** walnut-coloured oak design, handle in Hörmann colour CH 703.



Handle embellishment in Decograin Rosewood **//NEW** Mahogany-coloured timber design, handle in Hörmann colour CH 703.

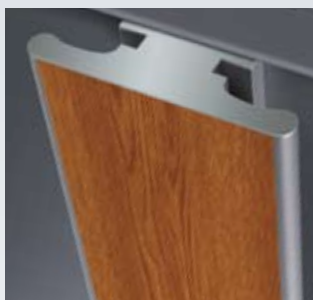

Handle embellishment in Decograin Golden Oak **//NEW** medium brown, golden yellow oak design, handle in Hörmann colour CH 703.

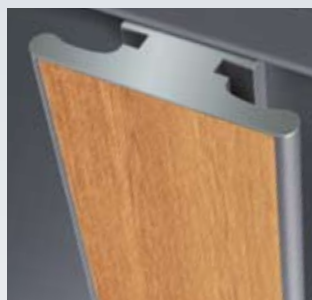

Handle embellishment in Decograin Light Oak **//NEW** light, warm oak design, handle in Hörmann colour CH 703.



▲ **Style 567** in Hörmann colour CH 703, handle in Hörmann colour CH 703 and handle embellishment in Decograin Dark Oak with side element (optional).



Style 565 TopPrestige in Traffic white RAL 9016, with fascia frame Rondo 70 (optional).



Style 566 TopPrestige in Traffic white RAL 9016, with fascia frame Rondo 70 (optional).



Style 567 TopPrestige in Traffic white RAL 9016, with fascia frame Rondo 70 (optional).

Particularly distinguished glass

Fluted and sand-blasted





Style 553 TopPrestige in Traffic white RAL 9016, with fascia frame Rondo 70 (optional).



Style 558 TopPrestige in Traffic white RAL 9016, with fascia frame Rondo 70 (optional).



Style 554 TopPrestige in Traffic white RAL 9016, with fascia frame Rondo 70 (optional).



Style 555 TopPrestige in Traffic white RAL 9016, with fascia frame Rondo 70 (optional).



Style 556 TopPrestige in Traffic white RAL 9016, with fascia frame Rondo 70 (optional).



Style 557 TopPrestige in Traffic white RAL 9016, with fascia frame Rondo 70 (optional).



▲ **Style 557** TopPrestige in the Hörmann colour CH 703, with side elements and fascia frame Rondo 70 (optional).



▲ **Style 553** TopPrestige in the Hörmann colour CH 607, with side elements 553 MG and fascia frame Rondo 70 (optional).

◀ **Style 554** TopPrestige in Traffic white RAL 9016, with side elements and fascia frame Rondo 70 (optional).

Powerful overall impression

Entrance door and garage door matched to each other



▲ **Style 845** TopPrestige in Traffic white RAL 9016, with side element and sectional garage door LPU40, M-ribbed, Silkgrain in Traffic white RAL 9016.



Style 693 TopPrestige in Traffic white RAL 9016.



Style 861 TopPrestige in Traffic white RAL 9016, with fascia frame Rondo 70 (optional).

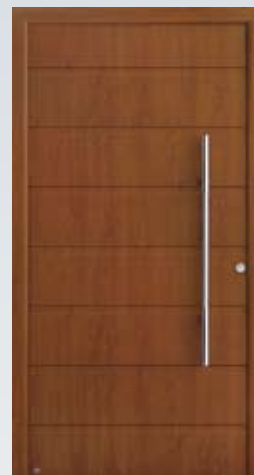

Style 861 Golden Oak TopPrestige in Decograin surface Golden Oak, with fascia frame Rondo 70 as standard.

After exact on-site measurement, your Hörmann specialist dealer will offer expert advice in choosing the perfect overall look from these entrance door styles.

Perfectly matched: Entrance door styles and sectional garage doors, M or L-ribbed

The large Hörmann matching programme provides you with aligned entrance door and garage door ribbing options for a matching appearance. The result: No optical offset from the base line. You will see: The beauty of your home is reflected in these small but crucial details.

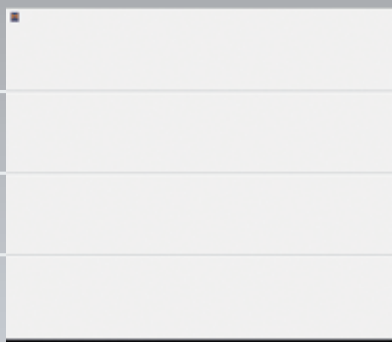

TopPrestige entrance doors:

Style 875 TP
Style 895 TP
Style 898 TP

Sectional garage doors, L-ribbed:

with a door height of 2000 mm
with a door height of 2125 mm
with a door height of 2250 mm



TopPrestige entrance doors:

Style 825 TP
Style 845 TP
Style 855 TP

Sectional garage doors, M-ribbed:

with a door height of 2000 mm
with a door height of 2125 mm
with a door height of 2250 mm



Entrance door infill cross-section



Sectional garage door cross-section

Matched entrance and garage doors

The cross-section of the entrance door and garage doors clearly shows the ribbed look is a result of the grooves in the infill. In the garage door, it comes from the ribbing of the individual sections or the section transitions.

**Quick and clean within a single day
Professional and competent entrance door modernisation**



Removal

The renovation of an entrance door is a routine task for Hörmann professionals, which they can handle quickly and cleanly on a single day. The measurement at your home and the selection of the new door is soon followed by the modernisation process. Step 1: Your old door is professionally and cleanly dismantled and disposed of in an environmentally-friendly manner.



Fitting

Step 2: The new Hörmann entrance door is fitted by the authorised Hörmann partner according to the measurements. The special entrance door threshold neatly covers then transition from the exterior to the exterior area. The threshold is fixed to the ground by concealed screws.



Adjustment

Step 3: The Hörmann fitter precisely adjusts the entrance door during fitting allowing you to enjoy your new door for a long time. This ensures the optimal functioning of your Hörmann entrance door right from the start.

The Hörmann Design programme

Garage door and entrance door combined harmoniously with glass and stainless steel elements



▲ **Style 173** TopPrestige in Traffic white RAL 9016, with side element (optional).

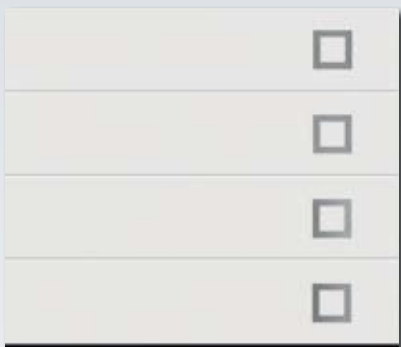

Sectional garage door **style 453** in Traffic white RAL 9016.



Style 173 TopComfort in Traffic white RAL 9016.



Sectional garage door **style 457** in Traffic white RAL 9016.



Style 188 TopPrestige in Traffic white RAL 9016.

Ideally suited for blocks of flats

Variable side elements, transom lights, letter box systems



▲ **Style 100** in Anthracite grey RAL 7016, with side elements and letter box system (optional).

Clever combination:

Expand your entrance door according to your wishes

The styles 100 and 101 are available with different side elements, transom lights and horizontal rails.

Perfectly attuned to your wishes:

Letter box systems

Hörmann can furnish you with the letter box system to suit your taste and the number of flats. Letter box systems and letter drops are available with bell buttons, light switches, and intercom mesh, all with high-grade stainless steel covers and with thermally insulated aluminium panel infill plate for simple mounting without extensive brickworks.



// Version available from summer 2011!



Style 100 in Traffic white RAL 9016.



Style 101 in Traffic white RAL 9016.

Well thought out: Hörmann canopies

An attractive look and protection in any kind of weather

Style 105

Stainless steel canopy as shown on the right, including acrylic glass, dimensions 1600 × 900 mm (dimensions 2000 × 1000 mm) side fascia in stainless steel, single-pane safety glass, height 2000 mm, depth 900 mm (top)



Style 405

Aluminium canopy in Traffic white RAL 9016, including acrylic glass, dimensions 2000 × 1000 mm.



Style 505

Aluminium canopy in Traffic white RAL 9016, including acrylic glass, dimensions 2000 × 1000 mm.



Style 605

Aluminium canopy in Traffic white RAL 9016, including acrylic glass, dimensions 2000 × 1000 mm.



Style 605 CH 703

Aluminium canopy in Hörmann colour CH 703, including acrylic glass, dimensions 2000 × 1000 mm.



Full range of colours for you

To match your entrance door to your home

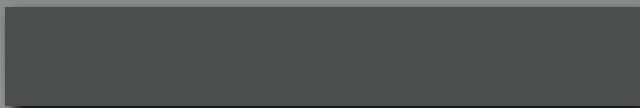

Hörmann colour CH 703 Anthracite, structured

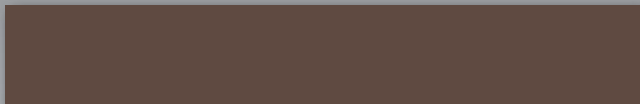

Hörmann colour CH 607, Chestnut, structured

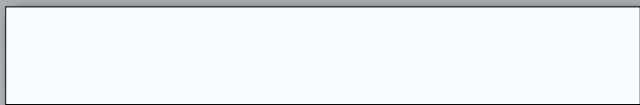

RAL 9016 M Traffic white, matt

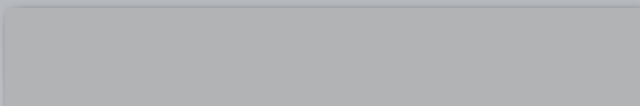

RAL 9006 White aluminium, silk-gloss

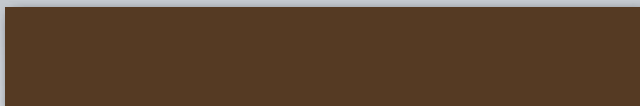

RAL 8028 Terra brown, matt



RAL 7040 Window grey, matt

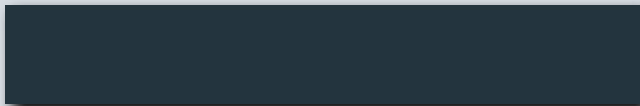

RAL 7016 Anthracite grey, matt

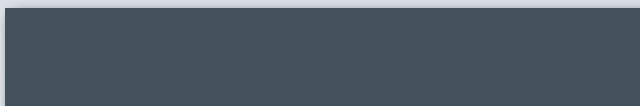

RAL 7015 Slate grey, matt

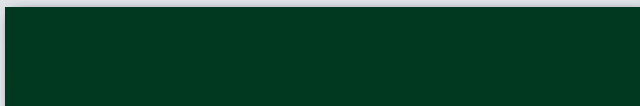

RAL 6009 Fir green, matt

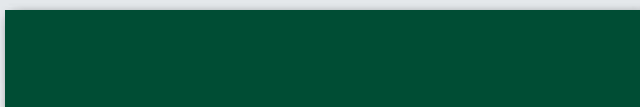

RAL 6005 Moss green, matt



RAL 3003 Ruby red, matt

You have a free choice of colours for your new Hörmann entrance door. Match the door to the exterior facade of your home or use a contrasting colour. Select one of equally-priced preferred colours or any RAL colour. You can also select the interior side of your new entrance door. Ask your specialised Hörmann dealer about delivery times and price of the style and colour of your choice.

Select one of 11 equally-priced preferred colours for a surcharge

Colour coating on both sides

All Hörmann entrance doors in standard Traffic white RAL 9016 are powder-coated on the inside and outside. Entrance doors in 11 preferred colours are powder-coated on the outside. (Inside in Traffic white RAL 9016, high gloss as standard). On request, entrance doors can be colour-coated on both sides, even in different colours.

Colour in line with your individual wishes

Besides our 11 equally-priced preferred colours, you can also choose an entrance door in any of the RAL colours (signal and pearl-effect colours on request). Pick the colour that best fits your home!



Shades matching Hörmann garage doors

Each entrance door also has a Hörmann garage door in a matching shade. For more information, ask your Hörmann specialist dealer.

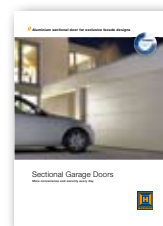

Dark colours should be avoided if the aluminium entrance door is exposed to the sun, as a possible deformation of the leaf may impair door function and leaktightness.

Securing excellent properties

Highest protection matched with convenient operation

You can equip your door with intelligent technology for increased comfort and security beyond the standard security equipment. Hörmann offers you the latest options ranging from mechanical locking with the S-3 S security package or electronic locking with the S-5 Comfort package, as well as convenient access control using fingerprints. Consult your Hörmann partner for more information about these options.

TIP:

The S-5-Automatic/comfort locks have been tested and certified by the VDS (German Property Insurance Association). This means that the self-locking doors are considered locked/bolted in case of a break-in, maintaining your claims towards your property insurance.





Graduated increased security

Hörmann offers you various security packages providing graduated additional security and comfort.

Secure opening with an integrated steel bar:

The **S-3 S** security package features a steel bar integrated in the lock. It allows you to open the door for only a small gap without strangers being able to push the door open completely. This security package is also available with an automatic lock (**S-5 S Automatic**) which mechanically locks your entrance door when it is pulled shut. The automatic lock is also available without a steel bar (**S-5 Automatic**).

Automatic locking – convenient opening:

The **S-5 Comfort** security packages feature an automatic lock that secures the door when pulled shut. When opening via one of the control element options (internal push button, hand transmitter, etc.), an integrated motor releases the lock and the door can be easily opened. Of course you can continue to unlock the door with a key.



1 Push button opening:

With **S-5 Comfort**, your entrance door can be opened at the push of a button from the inside, e.g. via the house intercom. This is especially suited for blocks of flats.

2 With transponder technology:

With **S-5 Comfort Plus**, you can additionally open your door very conveniently from the outside via transponder technology, i.e. with an electronic key without having to touch the door.



3 Via finger print:

S-5 Comfort Scan opens your door with a finger scanner. **You and your family will no longer need a key. By the way, you can also equip your Hörmann garage door with this technology.**

A variety of glazing options

Based on your personal preferences

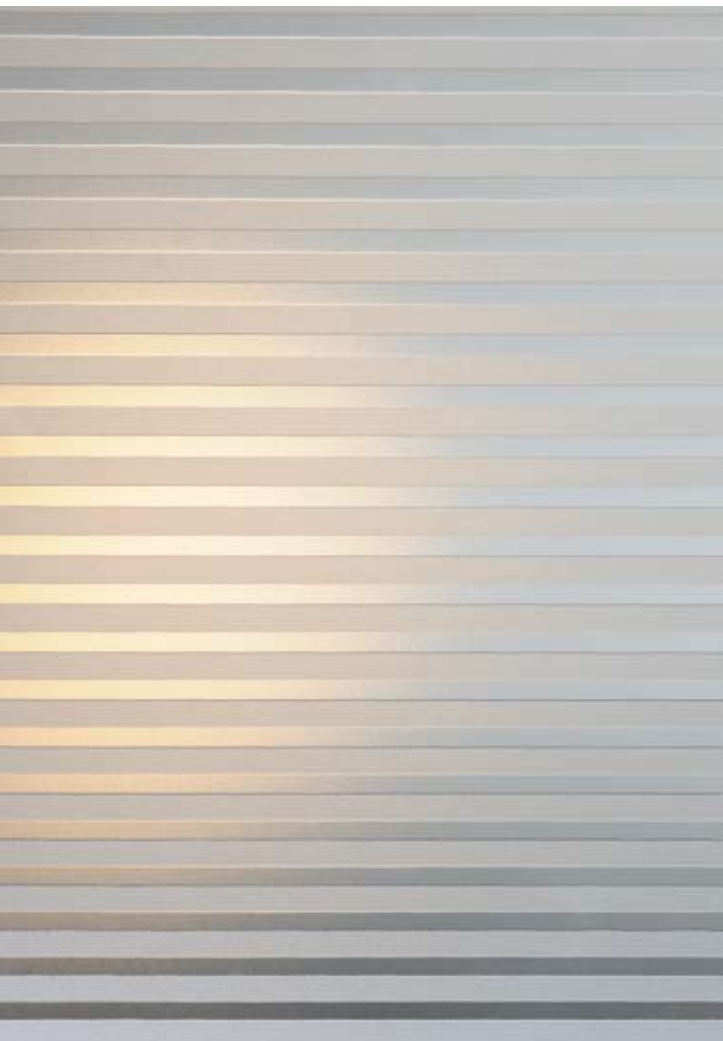

Ornament Micrograin **//NEW**

Each glass type has a different look depending on colour, structure and finish. In addition to the glass types we suggested in the catalogue images, you may choose from any other glass type according to your own personal preference. You will find an overview of the most popular glass types here and your specialised Hörmann dealer will be able to provide you with prices and delivery times.



Float clear, sand-blasted



Parsol grey, sand-blasted



504 white



Silk white, embossed



Stopsol blue, sand-blasted



Mastercarré



Reflo



Cathedral white



Stopsol grey, sand-blasted



Masterligne



Pave white



Ornamental glass
Baroque white



Ornamental glass
Chinchilla white



Ornamental glass
Silvit178bronze



Ornamental glass
Niagara white



Royal Flash white



597 white



Royal Trio white



Flûtes



Masterpoint



Madras silk, etched



Ornamental glass Gothic white



Ornament 553



Satinato

Completely under control

With a design tailor-made on your wishes

Throughout this catalogue, we have selected a matching handle from the numerous handle options for each entrance door style shown. But this is only a suggestion. You can select your personal favourite from our programme according to your wishes and vision. Because it is your taste that matters. Here is an overview of all handles at a glance. Your specialised Hörmann dealer can provide you with prices and delivery times.

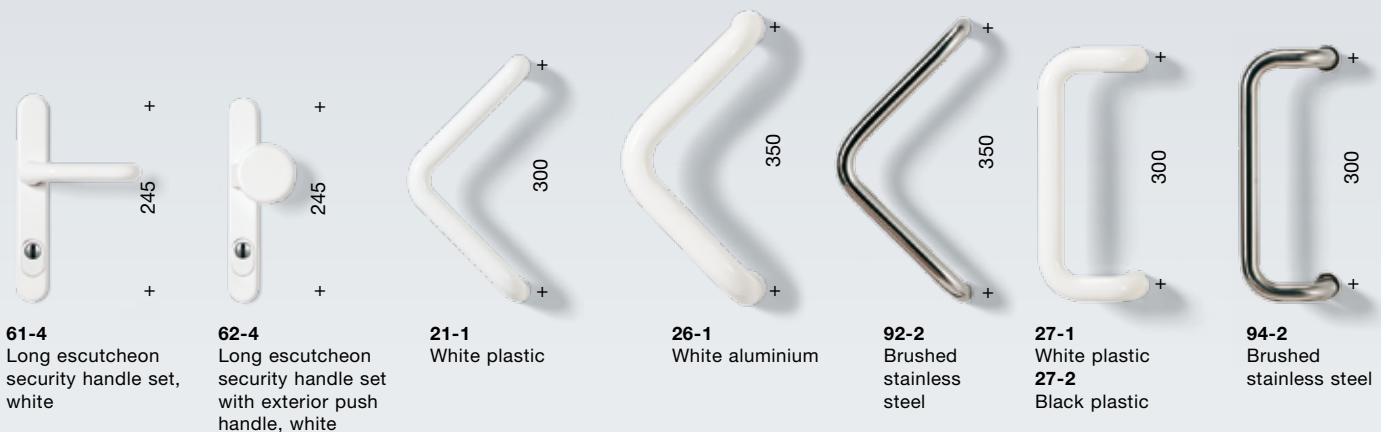
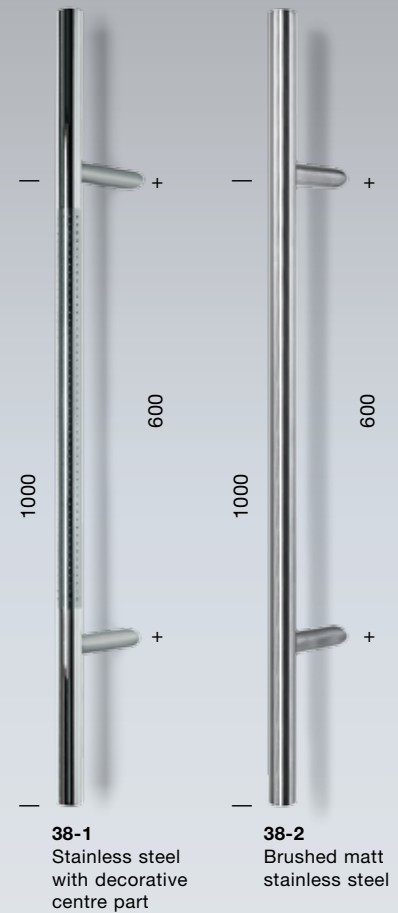

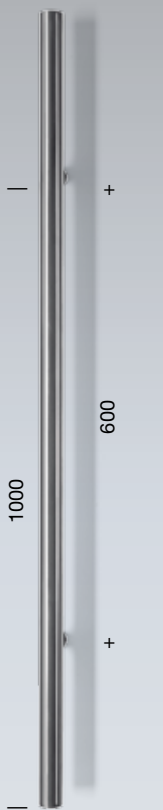

HÖ 500
Brushed matt stainless steel

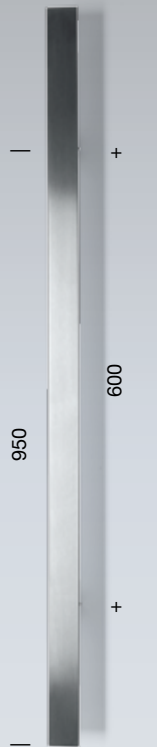

HÖ 600
Brushed matt stainless steel

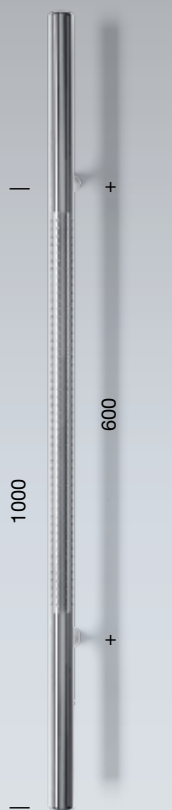

HÖ 700
Stainless steel with decorative centre part

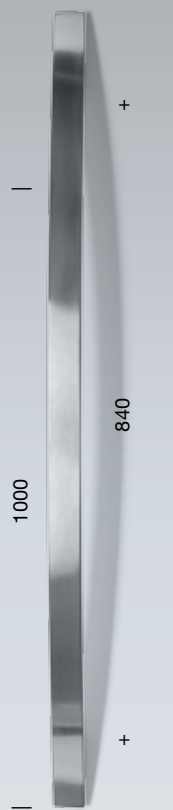

HÖ 300
Brushed matt stainless steel



HÖ 200
Brushed matt stainless steel



HÖ 100
Brushed matt stainless steel

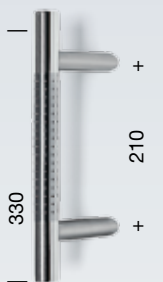

14-1
Stainless steel with decorative centre part

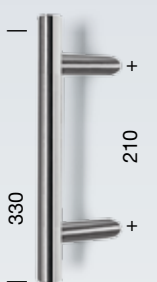

14-2
Brushed matt stainless steel

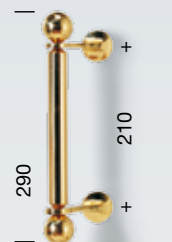

81-1
Polished brass

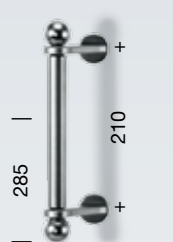

11-1
Matt stainless steel



29-1
Solid brass, bronzed



Hörmann: Quality without Compromise



Hörmann KG Amshausen



Hörmann KG Antriebstechnik



Hörmann KG Brandis



Hörmann KG Brockhagen



Hörmann KG Dissen



Hörmann KG Eckelhausen



Hörmann KG Freisen



Hörmann KG Ichtershhausen



Hörmann KG Werne



Hörmann Genk NV, Belgium



Hörmann Alkmaar B.V., Netherlands



Hörmann Legnica Sp. z o.o., Poland



Hörmann Beijing, China



Hörmann Tianjin, China



Hörmann LLC, Montgomery IL, USA



Hörmann Flexon, Leetsdale PA, USA

Hörmann is the only manufacturer worldwide that offers you a complete range of all major building products from one source. We manufacture in highly-specialised factories using the latest production technologies. The close-meshed network of sales and service companies throughout Europe, and activities in the USA and China, make Hörmann your strong partner for first-class building products, offering "Quality without Compromise".

GARAGE DOORS

OPERATORS

INDUSTRIAL DOORS

LOADING EQUIPMENT

HINGED DOORS

DOOR FRAMES

Hörmann (UK) Ltd, Gee Road, Coalville, Leicestershire LE67 4JW
Phone (01530) 513000, Fax (01530) 513001

