

Steel and Stainless Steel Seating



M3 Straight Seats

Ollerton and Sineu Graff offer a variety of seating styles and options providing solutions for almost any individual requirement. Ollerton is renowned for style, quality and value. M3 Stainless Steel and Festival Steel Seating systems are possibly the most versatile and flexible available. The modularity of the systems enables seats and benches to be specified in a number of ways.

Sineu Graff's prestigious collection of European Street Furniture showcases steel and stainless steel seating, which facilitates the integration of designs into the most varied of settings. Steel products can be supplied in a range of RAL (high gloss) or Sable (matt textured) colours. The Sineu Graff street furniture is made of steel and stainless steel and can be found under the City and Urban ranges.

The design for the M3 and Festival seating systems is stylish and versatile. Straight and curved seats and benches can be designed to any length, any internal radii above 600mm and in any combination. M3 and Festival have been specified in circles, squares and sweeping serpentine curves to provide functional points to many designers' schemes.

Seats are produced in numerous standard designs, including straight and back to back seats, plus inward and outward facing curved seat segments and circular seats. Almost endless permutations are possible that can retain the strength, safety and vandal resistant features of the individual straight seats and benches.

Steel and Stainless Steel Seating

M3

OLLERTON



M3 Straight Seat, Selby

- Material:** Manufactured from 316L grade stainless steel. The system is less prone to pitting and staining than those in lower grades and is more durable and low maintenance.
- Seating Slats:** Standard gauge of steel in seating slat is 30mm wide x 5mm thick. This provides optimal strength so they will not bend, making the slats less prone to damage through vandalism. Each slat is wrapped around the top and lower supporting tubes and welded at three points of contact. This ensures rigidity and strength in the structure making the seat less prone to vandals trying to prise away slats.
- Legs and Frame:** Manufactured from a heavy gauge stainless steel tube 60.3mm diameter and 3mm wall thickness. Legs are continuous pieces, fully welded to the frame. This makes it extremely strong and ensures that it is difficult for it to be removed from the legs and therefore less likely to be stolen.
- Weight:** A straight seat weighs 70kg.
- End Discs:** Engraved discs are fully welded to the end of the frame tubes. This prevents ingress of dirt and water and protects the seat in the long term.
- Options:** Arm rests can be provided at any position. Freestanding legs, surface trim plates and demountable ground sockets are also available. A preventative bar is available which stops people sitting on the back of the seat backrest.
- Customisation:** Engraved motifs can be commissioned for endcaps and armrests. Plaques may also be specified.

M3 STRAIGHT SEAT

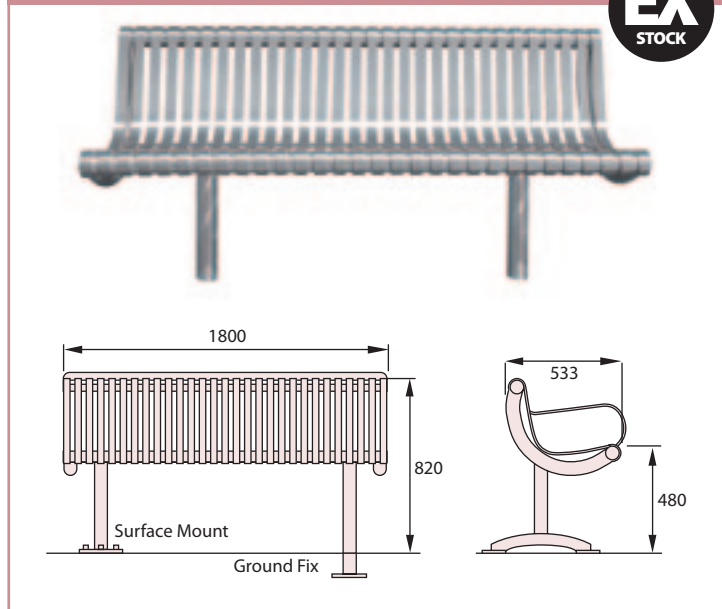

M3 STRAIGHT SEAT WITH TIMBER SLATS

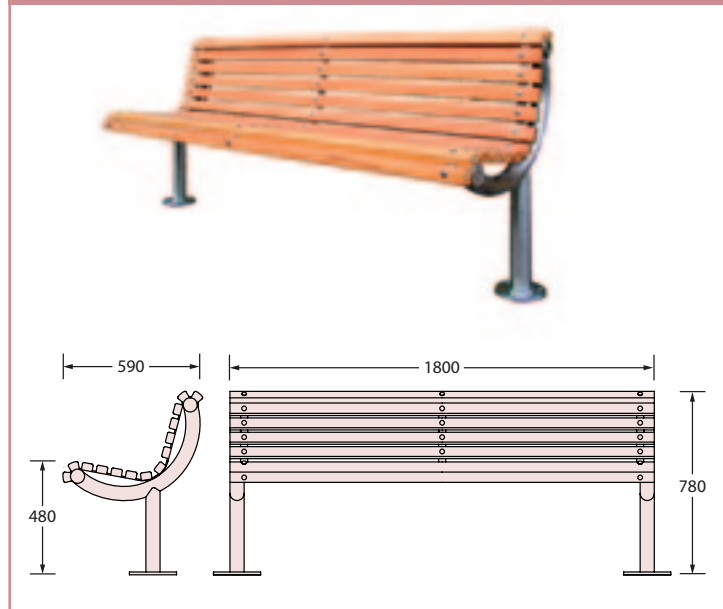

| Product Description | Seat Span (mm) | Seat Height (mm) | Standard Radius (mm) | Weight (kg) | Standard Finish | Length Optional Length (mm) | OPTIONS | | | | | | | Guide Price | |
|---|----------------|------------------|----------------------|-------------|-----------------|-----------------------------|---------------|---------------|-------------------|--------------|--------------|---------------------------|---------------------|-------------|-------------------|
| | | | | | | | Fixing Method | | | | | Add Ons | | | |
| | | | | | | | Free Standing | Surface Mount | Sub-Surface Mount | Ground Fixed | Wall Mounted | Demountable Ground Socket | Surface Trim Plates | | Leg Diameter (mm) |
| M3 Straight Seat with Stainless Steel Slats | 1800 | 480 | n/a | 70 | Stainless Steel | 2000, 2400 or 3000 | ■ | ■ | ■ | ■ | ■ | ■ | 70 | ■ | £1295* |
| M3 Straight Seat with Hardwood Slats | 1800 | 480 | n/a | 45 | Iroko Hardwood | 2000 or 2400 | ■ | ■ | ■ | ■ | ■ | ■ | 70 | ■ | £1320* |

*Prices shown for root fix only. For other options contact sales office.



M3 Exeter Seat with arm rests

M3 EXETER SEAT

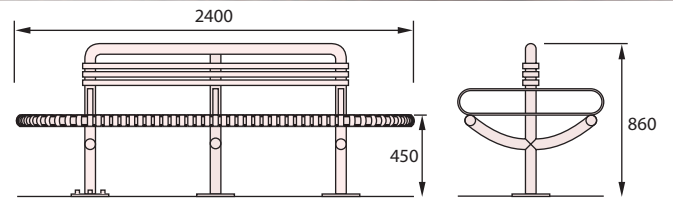

Shown with arm rest option

M3 STRAIGHT BENCH

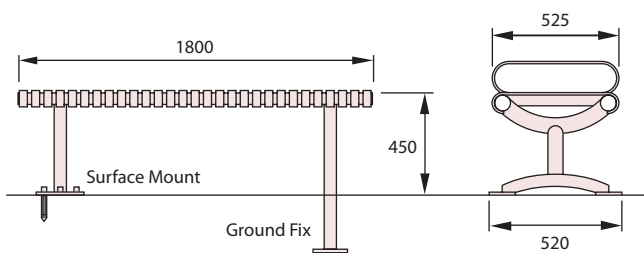

M3 BACK TO BACK SEAT

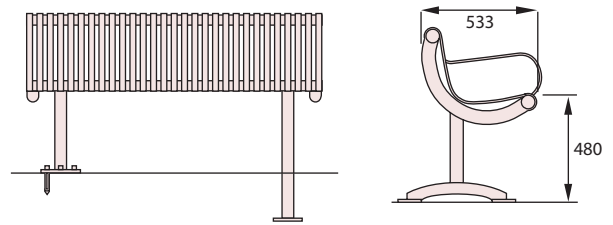

Shown with arm rest option

| Product Description | Seat Span (mm) | Seat Height (mm) | Standard Radius (mm) | Weight (kg) | Standard Finish | Length | OPTIONS | | | | | | | Guide Price* | | | |
|---|----------------|------------------|----------------------|-------------|------------------|--------------|----------------------|---------------|---------------|-------------------|--------------|--------------|---------------------------|--------------|---------------------|-------------------|-----------|
| | | | | | | | Optional Length (mm) | Fixing Method | | | | | Demountable Ground Socket | | Add Ons | | |
| | | | | | | | | Free Standing | Surface Mount | Sub-Surface Mount | Ground Fixed | Wall Mounted | | | Surface Trim Plates | Leg Diameter (mm) | Arm Rests |
| M3 Exeter Seat | 2400 | 450 | n/a | 110 | Stainless Steel | | | ■ | ■ | ■ | ■ | ■ | ■ | ■ | ■ | ■ | £4800 |
| M3 Back to Back Seat with Stainless Steel Slats | 1800 x 2 | 480 | n/a | 140 | Stainless Steel | 2000 or 2400 | ■ | ■ | ■ | ■ | ■ | ■ | ■ | ■ | 70 | ■ | £2500 |
| M3 Back to Back Seat with Hardwood Slats | 1800 x 2 | 480 | n/a | 90 | Treated Hardwood | 2000 or 2400 | ■ | ■ | ■ | ■ | ■ | ■ | ■ | ■ | 70 | ■ | £2350 |
| M3 Straight Bench with Stainless Steel Slats | 1800 | 450 | n/a | 52 | Stainless Steel | 2000 or 2400 | ■ | ■ | ■ | ■ | ■ | ■ | ■ | ■ | 70 | ■ | £1095 |
| M3 Straight Bench with Hardwood Slats | 1800 | 450 | n/a | 22 | Iroko Hardwood | 2000 or 2400 | ■ | ■ | ■ | ■ | ■ | ■ | ■ | ■ | 70 | ■ | £995 |

*Prices shown for root fix only. For other options contact sales office.



M3 Pedestal Seat with arm rests

M3 PEDESTAL SEAT

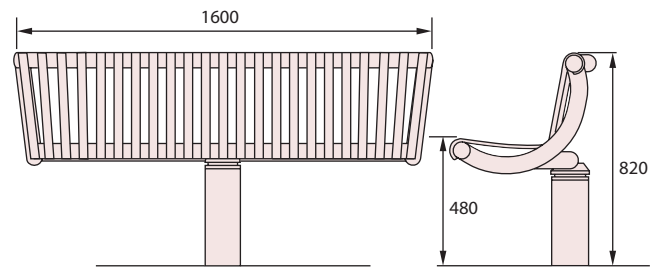
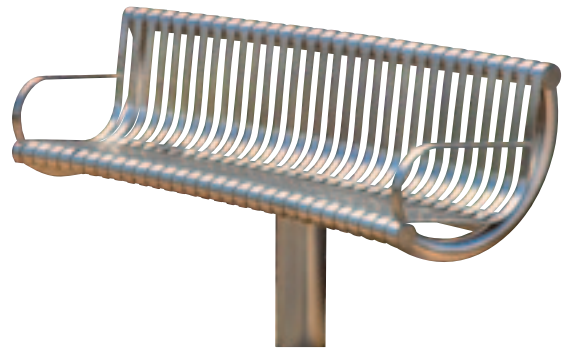

Shown with arm rest option



M3 Tree Seat and Curved Bench

M3 TREE SEAT

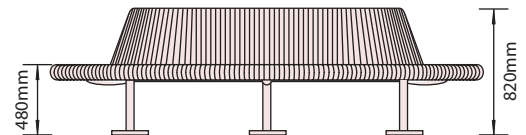

| Product Description | Seat Span (mm) | Seat Height (mm) | Standard Radius (mm) | Weight (kg) | Standard Finish | Length Optional Length (mm) | OPTIONS | | | | | Add Ons | | | Guide Price* | |
|---|----------------|------------------|----------------------|-------------|-----------------|--------------------------------|---------------|---------------|-------------------|--------------|--------------|---------------------------|---------------------|-------------------|--------------|-----------|
| | | | | | | | Free Standing | Surface Mount | Sub-Surface Mount | Ground Fixed | Wall Mounted | Demountable Ground Socket | Surface Trim Plates | Leg Diameter (mm) | | Arm Rests |
| M3 Pedestal Seat with Stainless Steel Slats | 1600 | 480 | 6500* | 80 | Stainless Steel | 1800 | | ■ | ■ | ■ | | | | | ■ | £1950 |
| M3 Tree Seat with Stainless Steel Slats | 2250 | 480 | 600* | 212/280 | Stainless Steel | 2850 (span) | ■ | ■ | ■ | ■ | | ■ | ■ | 70 | ■ | £5200 |

*External radius **Internal diameter 1200/1800

*Prices shown for root fix only. For other options contact sales office.



Bespoke M3 Curved Seat, Serpentine Bench, litter bins, tree grille and frame, bollards with white reflective tape, Chichester College

M3 CURVED SEAT

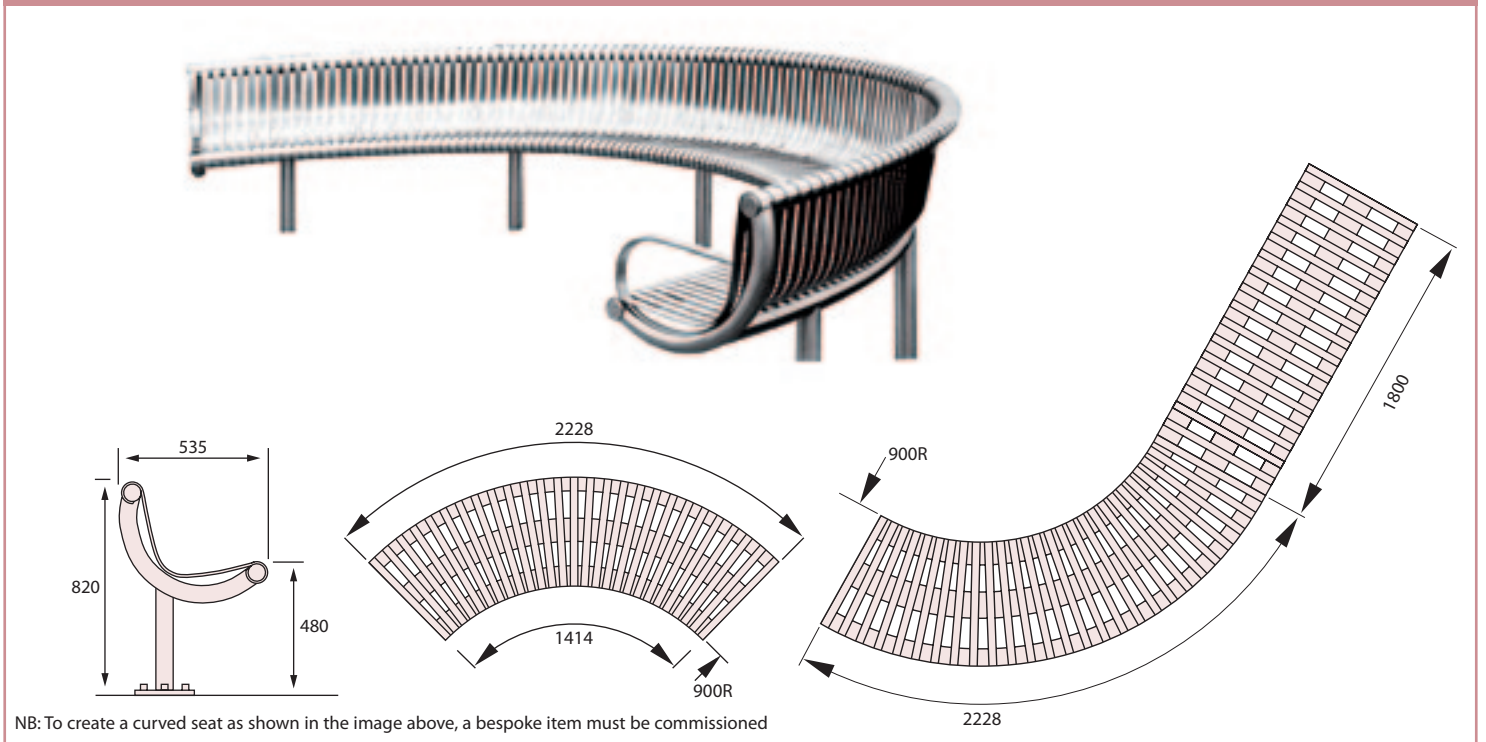

| Product Description | Seat Span (mm) | Seat Height (mm) | Standard Radius (mm) | Weight (kg) | Standard Finish | Length | OPTIONS | | | | | Demountable Ground Socket | Add Ons | | | Guide Price* |
|---|---------------------------------------|------------------|----------------------|-------------|-----------------|------------|---------------|---------------|-------------------|--------------|--------------|---------------------------|---------------------|--------------------|-----------|--------------|
| | | | | | | | Free Standing | Surface Mount | Sub-Surface Mount | Spigot Mount | Wall Mounted | | Surface Trim Plates | Legs Diameter (mm) | Arm Rests | |
| M3 Curved Seat with Stainless Steel Slats | 1885 [†] /2970 ^{††} | 480 | 900 | 70/93 | Stainless Steel | Any Length | ■ | ■ | ■ | ■ | ■ | ■ | ■ | 70 or 140 | ■ | POA |
| M3 Hockey Stick Seat with Stainless Steel Slats | 3214 [†] /4028 ^{††} | 480 | 900 | 140 | Stainless Steel | Any Length | ■ | ■ | ■ | ■ | ■ | ■ | ■ | 70 | ■ | POA |

[†]Inward ^{††}Outward



Bespoke M3 Serpentine Bench with armrests, Royal Armouries Museum, Leeds

M3 CURVED BENCH

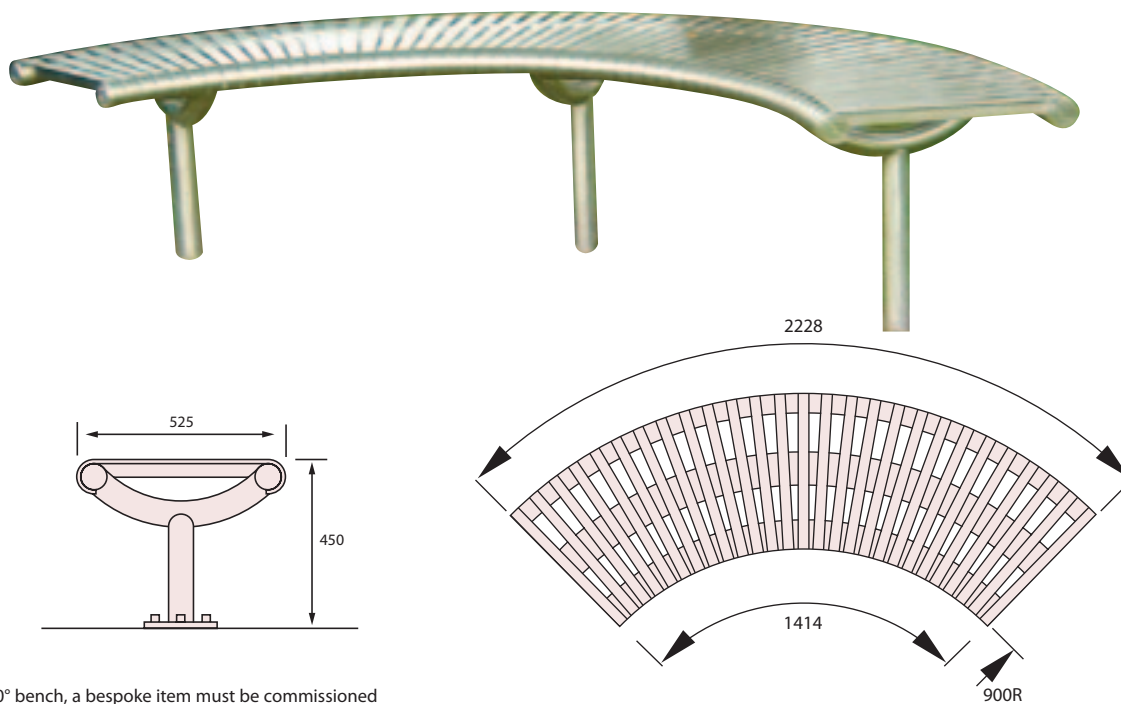

NB: To create a 360° bench, a bespoke item must be commissioned

| Product Description | Seat Span (mm) | Seat Height (mm) | Standard Radius (mm) | Weight (kg) | Standard Finish | Length | OPTIONS | | | | | Add Ons | | | Guide Price | |
|--|----------------|------------------|----------------------|-------------|-----------------|-------------|----------------------|---------------|---------------|-------------------|--------------|--------------|---------------------------|---------------------|-------------|--------------------|
| | | | | | | | Optional Length (mm) | Free Standing | Surface Mount | Sub-Surface Mount | Ground Fixed | Wall Mounted | Demountable Ground Socket | Surface Trim Plates | | Legs Diameter (mm) |
| M3 Curved Bench with Stainless Steel Slats | 2238 | 450 | 900 | 52/69 | Stainless Steel | Any Length | ■ | ■ | ■ | ■ | ■ | ■ | ■ | 70 | ■ | POA |
| M3 Serpentine Bench with Stainless Steel Slats | 3626 | 450 | 900 | 140/186 | Stainless Steel | Any length | ■ | ■ | ■ | ■ | ■ | ■ | ■ | 70 | ■ | POA |
| M3 Tree Bench | 2250 | 450 | 2836 | 158/207 | Stainless Steel | 2850 (span) | ■ | ■ | ■ | ■ | ■ | ■ | ■ | 70 | ■ | £4500 |

Steel and Stainless Steel Seating

Festival

OLLERTON



Festival Straight Seat

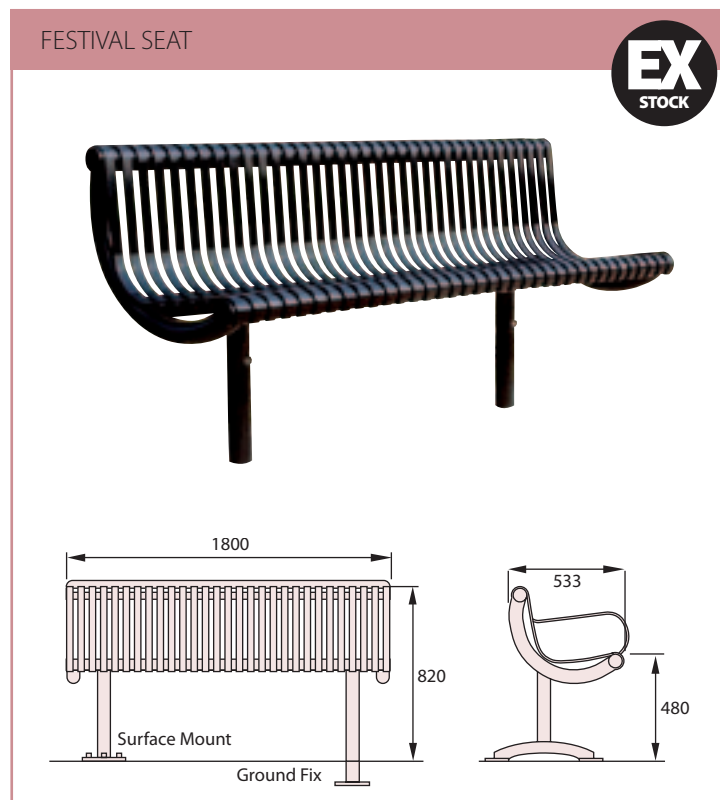

- Festival Steel Seating system is a versatile modular system that meets the demands of modern environments and enhances public spaces. Straight and curved seats and benches can be designed to any length, any internal radii above 600mm and in any combination. Festival Seating is popular in educational and healthcare establishments, and civic spaces.
- Seats are produced in numerous standard designs, including straight and back to back seats, plus inward and outward facing curved seat segments and circular seats.
- Almost endless permutations are possible that can retain the strength, safety and vandal resistant features of the individual straight seats and benches.
- **Material:** Mild steel, galvanised and polyester powder coated.
- **Colours:** A full standard range of RAL colours is available. Please refer to page 425 for more information on colour options.
- **Seating Sections:** Seating is also available with Iroko hardwood slats from renewable sources.
- **Options:** Arm rests can be provided at any position. Freestanding legs, surface trim plates, and demountable ground sockets are also available.
- **Customisation:** Engraved motifs can be commissioned for endcaps and arm rests. Plaques may also be required.

Steel and Stainless Steel Seating

Festival

OLLERTON



Festival straight seat with timber slats

- Stylish seating combining the design and form of the supports from the M3 and Festival ranges with hardwood timber slats.
- **Supports:** Available in either 316L grade satin polished stainless steel (M3) or in mild steel which is galvanised and polyester powder coated.
- **Seating Section:** Provided with Iroko hardwood timber slats sourced from renewable sources.
- **Options:** Arm rests can be provided at any position. Freestanding legs, surface trim plates and demountable ground sockets are also available.
- **Customisation:** Engraved motifs can be commissioned for endcaps and arm rests. Plaques may also be provided.

FESTIVAL STRAIGHT SEAT WITH TIMBER SLATS

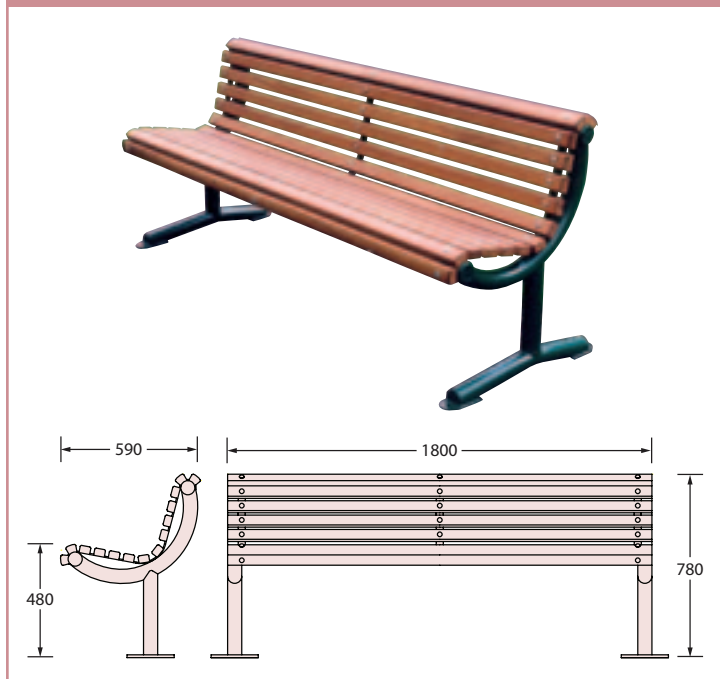

| Product Description | Seat Span (mm) | Seat Height (mm) | Standard Radius (mm) | Weight (kg) | Standard Finish | Length Optional Length (mm) | OPTIONS | | | | | Add Ons | | | Guide Price | |
|--|----------------|------------------|----------------------|-------------|----------------------|--------------------------------|---------------|---------------|---------------|--------------|--------------|---------------------------|---------------------|-------------------|-------------|-----------|
| | | | | | | | Free Standing | Surface Mount | Surface Mount | Ground Fixed | Wall Mounted | Demountable Ground Socket | Surface Trim Plates | Leg Diameter (mm) | | Arm Rests |
| Festival Straight Seat with Steel Slats | 1800 | 480 | n/a | 67 | PC In Any RAL Colour | 1800, 2000, 2400 or 3000 | ■ | ■ | ■ | ■ | ■ | ■ | ■ | 70 | ■ | £604 |
| Festival Straight Seat with Hardwood Slats | 1800 | 480 | n/a | 41 | Iroko Hardwood | 2000 or 2400 | ■ | ■ | ■ | ■ | ■ | ■ | ■ | 70 | ■ | £750 |



Festival Exeter Seat

FESTIVAL EXETER SEAT

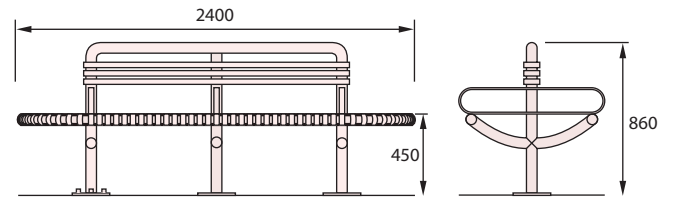

Festival Back to Back Seat

FESTIVAL BACK TO BACK SEAT

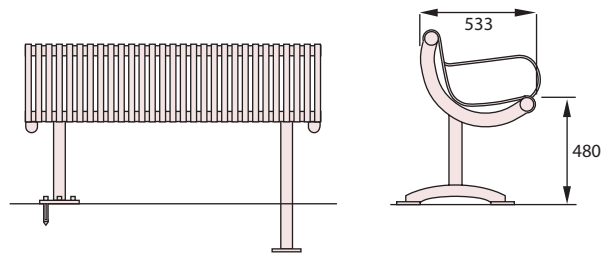

| Product Description | Seat Span (mm) | Seat Height (mm) | Standard Radius (mm) | Weight (kg) | Standard Finish | Length Optional Length (mm) | OPTIONS | | | | | Demountable Ground Socket | Add Ons | | | Guide Price* |
|--|----------------|------------------|----------------------|-------------|----------------------|-----------------------------|---------------|---------------|-------------------|--------------|--------------|---------------------------|---------------------|-------------------|-----------|--------------|
| | | | | | | | Fixing Method | | | | | | Surface Trim Plates | Leg Diameter (mm) | Arm Rests | |
| | | | | | | | Free Standing | Surface Mount | Surface Sub-Mount | Ground Fixed | Wall Mounted | | | | | |
| Festival Exeter Seat | 2400 | 450 | n/a | 210 | PC In Any RAL Colour | | ■ | ■ | ■ | | | | | | ■ | £2415 |
| Festival Back to Back Seat with Steel Slats | 1800 x 2 | 480 | n/a | 156 | PC In Any RAL Colour | 2000 or 2400 | ■ | ■ | ■ | ■ | ■ | ■ | 70 | ■ | ■ | £1260 |
| Festival Back to Back Seat with Hardwood Slats | 1800 x 2 | 480 | n/a | 82 | PC In Any RAL Colour | 2000 or 2400 | ■ | ■ | ■ | ■ | ■ | ■ | 70 | ■ | ■ | £1525 |

*Prices shown for root fix only. For other options contact sales office.



Festival Straight Benches

FESTIVAL STRAIGHT BENCH

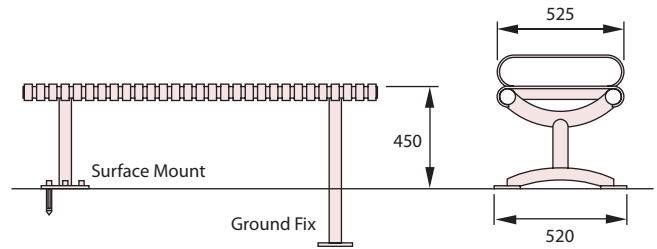

Festival Tree Seat and Curved Seat

FESTIVAL TREE SEAT

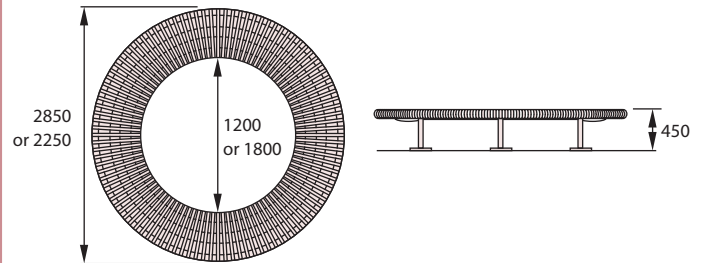

| Product Description | Seat Span (mm) | Seat Height (mm) | Standard Radius (mm) | Weight (kg) | Standard Finish | Length | OPTIONS | | | | | | | Guide Price* | | |
|---|----------------|------------------|----------------------|-------------|----------------------|--------------------------|---------------|---------------|---------------|--------------|--------------|---------------------------|---------------------|--------------|-------------------|-----------|
| | | | | | | | Fixing Method | | | | | Demountable Ground Socket | Add Ons | | | |
| | | | | | | | Free Standing | Surface Mount | Surface Mount | Ground Fixed | Wall Mounted | | Surface Trim Plates | | Leg Diameter (mm) | Arm Rests |
| Festival Straight Bench with Steel Slats | 1500 | 450 | n/a | 52 | PC In Any RAL Colour | 1800, 2000, 2400 or 3000 | ■ | ■ | ■ | ■ | ■ | ■ | ■ | 70 | ■ | £485 |
| Festival Straight Bench with Hardwood Slats | 1500 | 450 | n/a | 36 | Iroko Hardwood | 1800, 2000, 2400 or 3000 | ■ | ■ | ■ | ■ | ■ | ■ | ■ | 70 | ■ | £570 |
| Festival Tree Seat with Steel Slats | 2250 | 480 | 2850 | 253/310 | PC In Any RAL Colour | 2850 (span) | ■ | ■ | ■ | ■ | ■ | ■ | ■ | 70 | ■ | £2415** |

*Prices shown for root fixing only. For other options contact Sales Office.
 **Price shown for seat with internal diameter of 1200mm



Bespoke Festival Curved Seat, Glasgow

FESTIVAL CURVED SEAT

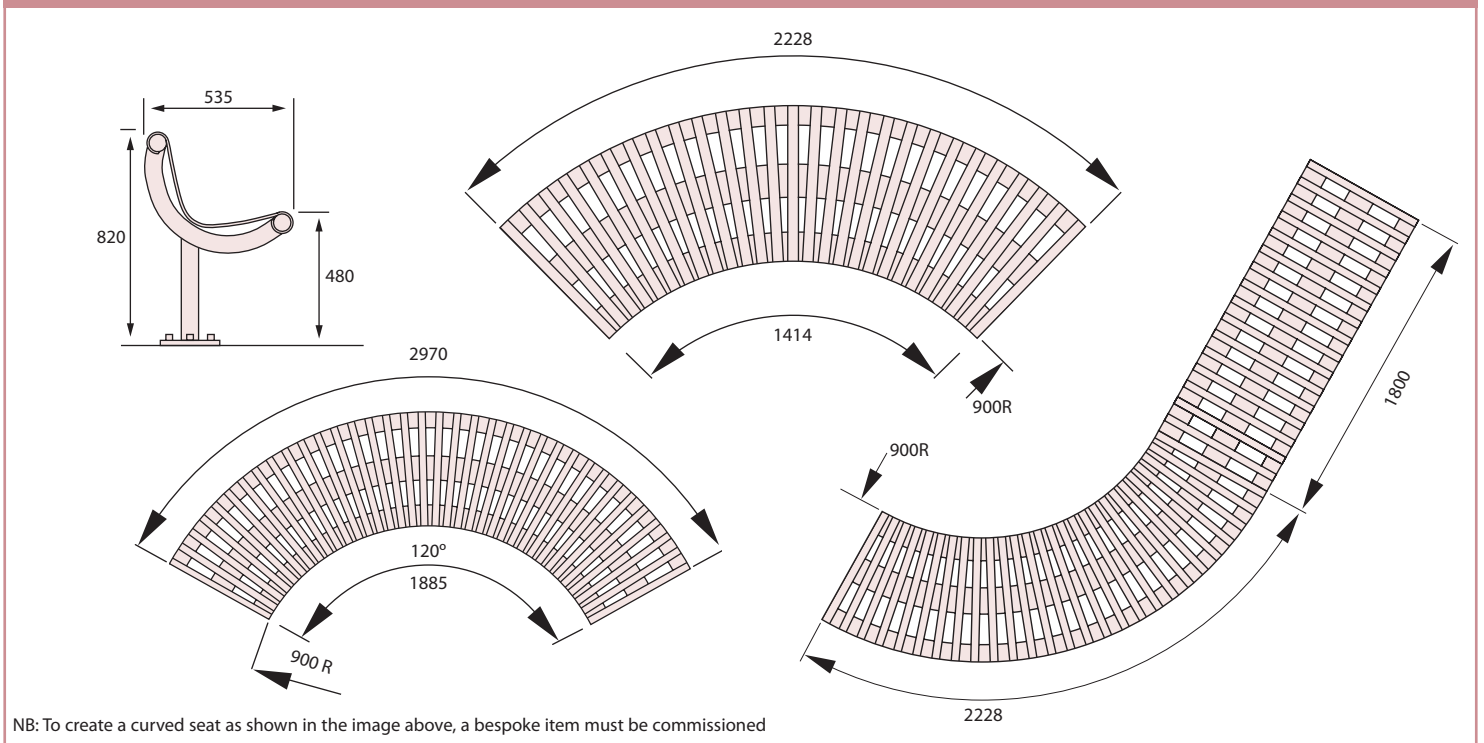

NB: To create a curved seat as shown in the image above, a bespoke item must be commissioned

| Product Description | Seat Span (mm) | Seat Height (mm) | Standard Radius (mm) | Weight (kg) | Standard Finish | Length Optional Length (mm) | OPTIONS | | | | | Add Ons | | | Guide Price | |
|---|-------------------------|------------------|----------------------|-------------|----------------------|-----------------------------|---------------|---------------|-------------------|--------------|--------------|---------------------------|---------------------|-------------------|-------------|-----------|
| | | | | | | | Free Standing | Surface Mount | Sub-Surface Mount | Ground Fixed | Wall Mounted | Demountable Ground Socket | Surface Trim Plates | Leg Diameter (mm) | | Arm Rests |
| Festival Curved Seat with Steel Slats | 1885/2970 ^{††} | 480 | 900 | 78/103 | PC In Any RAL Colour | Any Length | ■ | ■ | ■ | ■ | ■ | ■ | ■ | 70 or 140 | ■ | POA |
| Festival Hockey Stick Seat with Steel Slats | 3214/4028 ^{††} | 480 | 900 | 156 | PC In Any RAL Colour | Any Length | ■ | ■ | ■ | ■ | ■ | ■ | ■ | 70 | ■ | POA |
| Festival Pedestal Seat with Steel Slats | 1600 | 480 | 6500 | 78 | PC In Any RAL Colour | | | ■ | ■ | ■ | | | | | ■ | POA |

[†]Inward ^{††}Outward



Bespoke Festival Curved Bench, Queen Elizabeth School

FESTIVAL CURVED BENCH

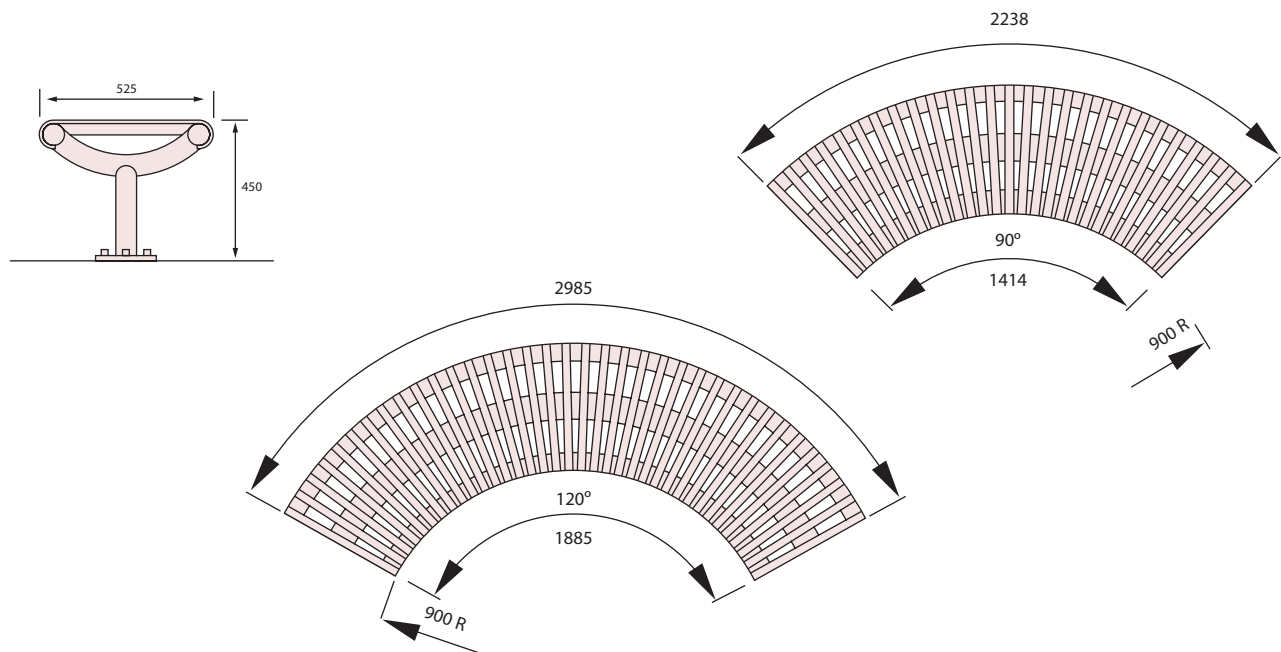

NB: To create a 360° bench, a bespoke item must be commissioned

| Product Description | Seat Span (mm) | Seat Height (mm) | Standard Radius (mm) | Weight (kg) | Standard Finish | Length Optional Length (mm) | OPTIONS | | | | | Add Ons | | | Guide Price | |
|--|--------------------------------------|------------------|----------------------|-------------|----------------------|--------------------------------|---------------|---------------|-------------------|--------------|--------------|---------------------------|---------------------|-------------------|-------------|-----------|
| | | | | | | | Free Standing | Surface Mount | Sub-Surface Mount | Ground Fixed | Wall Mounted | Demountable Ground Socket | Surface Trim Plates | Leg Diameter (mm) | | Arm Rests |
| Festival Curved Bench with Steel Slats | 2238 ¹ /1414 ² | 450 | 900 | 61/84 | PC In Any RAL Colour | Any Length | ■ | ■ | ■ | ■ | ■ | ■ | ■ | 70 | ■ | POA |
| Festival Serpentine Bench with Steel Slats | 3626 | 450 | 900 | 122/168 | PC In Any RAL Colour | Any Length | ■ | ■ | ■ | ■ | ■ | ■ | ■ | 70 | ■ | POA |
| Festival Tree Bench | 2250 | 450 | 2850 | 188/252 | PC In Any RAL Colour | 2850 (span) | ■ | ■ | ■ | ■ | ■ | ■ | ■ | 70 | ■ | £1890 |

¹Inward ²Outward

Steel and Stainless Steel Seating

Buffalo

OLLERTON



Buffalo Seat, Durham

- Strong yet comfortable, Buffalo Seating is manufactured in mild steel, hot dip galvanised and coated in up to two colours of your choice. Slats are steel or Iroko hardwood, the latter from renewable resources. For information on colours available, please turn to page 425.
- Coordinating litter bins are available.

BUFFALO BENCH WITH N SHAPE ENDS

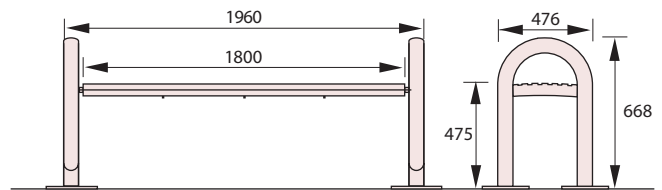

BUFFALO SEAT

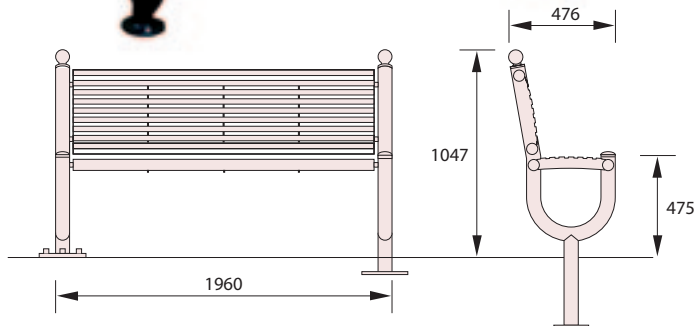

BUFFALO BENCH WITH U SHAPE ENDS

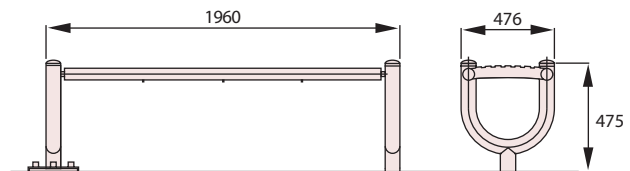

| Product Description | Seat Span (mm) | Seat Height (mm) | Weight (kg) | Standard Finish | Finish Hardwood Slats | OPTIONS | | | | Guide *Price |
|------------------------------------|----------------|------------------|-------------|----------------------|-----------------------|---------------|---------------------------------|--------------|-----------|--------------|
| | | | | | | Surface Mount | Fixing Method Sub-Surface Mount | Ground Fixed | Arm Rests | |
| Buffalo Seat with Steel Slats | 1800 | 475 | 90 | PC in Any RAL Colour | ■ | ■ | ■ | ■ | ■ | £780 |
| Buffalo 'U' Bench with Steel Slats | 1800 | 475 | 65 | PC in Any RAL Colour | ■ | ■ | ■ | ■ | ■ | £550 |
| Buffalo 'N' Bench with Steel Slats | 1800 | 475 | 65 | PC in Any RAL Colour | ■ | ■ | ■ | ■ | ■ | £550 |

*Prices shown for root fixing only. For other options contact sales office.

Steel and Stainless Steel Seating

Metropolitan

OLLERTON



Metropolitan Seat with steel section

- Manufactured from mild steel, hot dip galvanised and powder coated in a RAL colour of your choice, the Metropolitan seat and bench are suited to both contemporary and traditional landscapes.
- Seating sections and back rests feature a modern, perforated steel design, which are complemented by a stylish, arched leg profile.
- For a list of our 10 RAL colours offered as standard, but also information on additional RAL colour palette, please refer to page 425.

METROPOLITAN SEAT WITH STEEL SECTION

EX STOCK

METROPOLITAN BENCH WITH STEEL SECTION

EX STOCK

| Product Description | Seat Span (mm) | Seat Height (mm) | Standard Finish | Supplied Assembled | Fixing Method | | Guide Price |
|---------------------------------------|----------------|------------------|-----------------|--------------------|---------------|--------------|-------------|
| | | | | | Surface Mount | Ground Fixed | |
| Metropolitan Seat with Steel Section | 1818 | 443 | PC Steel | ■ | ■ | | £495 |
| Metropolitan Bench with Steel Section | 1818 | 455 | PC Steel | ■ | ■ | | £295 |

Steel and Stainless Steel Seating

Academy

OLLERTON



Academy Steel Seat

- With its simple column supports and narrow slat seating sections, the Academy seat and bench provide a functional, durable seating solution, suitable for any environment.
- The Academy is available in mild steel, which is zinc rich primed and can be polyester powder coated in almost any RAL colour. Armrests are available as an optional extra. For additional information on the RAL colours available, please turn to page 425.
- The Academy seat and bench can also be supplied in grade 316L stainless steel for a more contemporary finish. This high grade of stainless steel makes the material less prone to the effects of pitting and staining than lower grades, providing a durable, low maintenance solution.
- Academy seats and benches are supplied with an integral base plate fixing, which can be bolted directly onto finished surfaces, or positioned below ground level.

ACADEMY STEEL SEAT

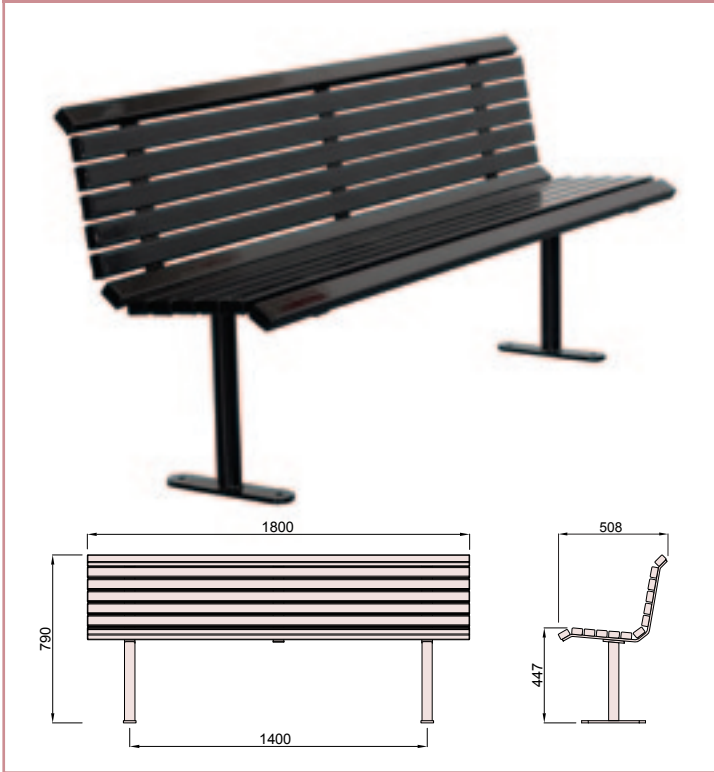

ACADEMY STEEL BENCH



ACADEMY STAINLESS STEEL SEAT



ACADEMY STAINLESS STEEL BENCH

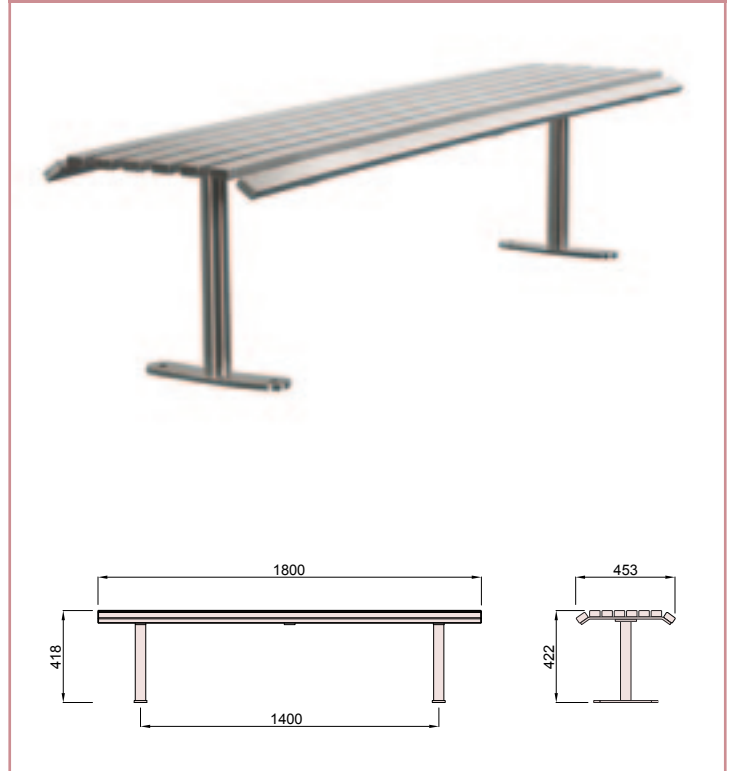

| Product Description | Seat Span (mm) | Seat Height (mm) | Standard Finish | Fixing Method | | Options | Guide Price |
|-------------------------------|----------------|------------------|-----------------|-------------------|---------------|---------|-------------|
| | | | | Sub Surface Mount | Surface Mount | | |
| Academy Steel Seat | 1800 | 447 | Steel | ■ | ■ | ■ | £420 |
| Academy Steel Bench | 1800 | 432 | Steel | ■ | ■ | ■ | £275 |
| Academy Stainless Steel Seat | 1800 | 437 | Stainless Steel | ■ | ■ | | £995 |
| Academy Stainless Steel Bench | 1800 | 422 | Stainless Steel | ■ | ■ | | £715 |

Steel and Stainless Steel Seating

Bercy and Rendezvous City



Bercy Seat, Bercy Bench and City Litter Bin

BERCY SEAT COMPOSITE

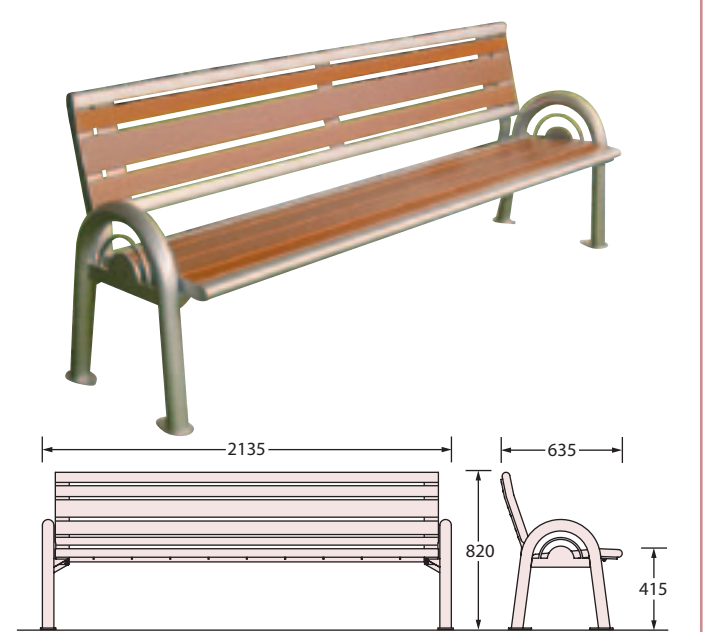

BERCY SEAT

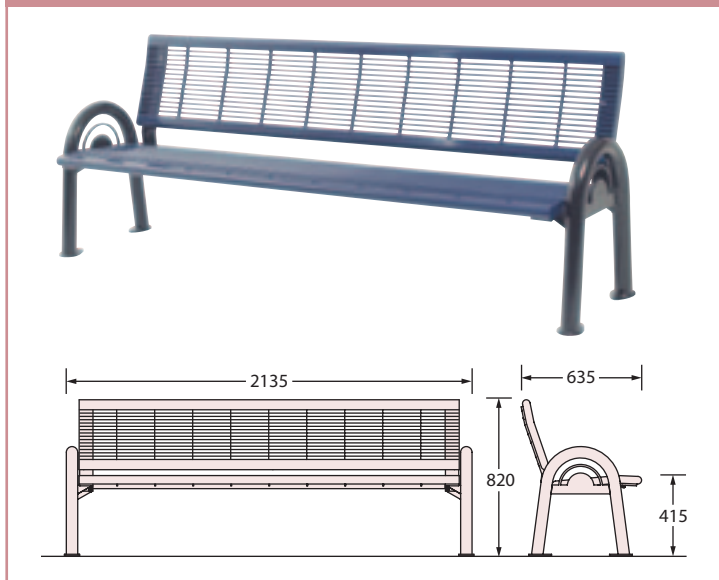

BERCY BENCH

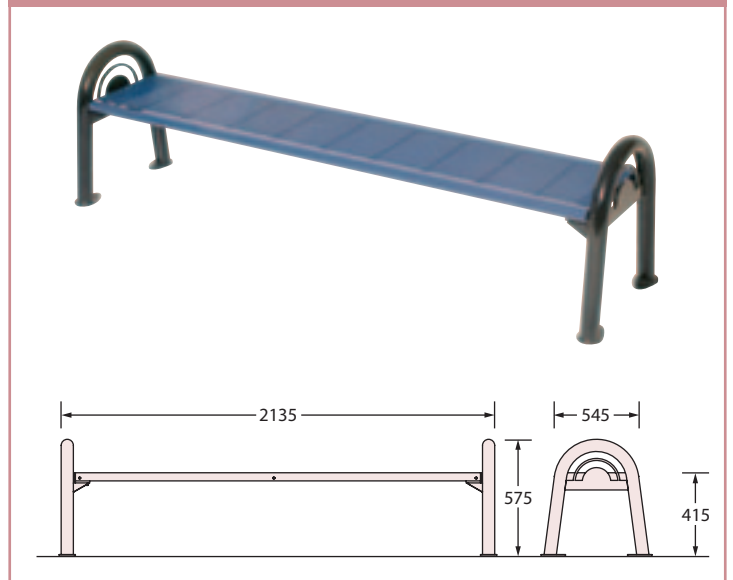

| Product Description | Seat Span (mm) | Seat Height (mm) | Weight (kg) | Seating Section | Seating Ends/Frames | Standard Finish | Fixing Method | | | Number Required | Guide Price | |
|----------------------|----------------|------------------|-------------|------------------|---------------------|-------------------------------------|---------------|---------------|--------------|-----------------|-------------|-------|
| | | | | | | | Free Standing | Surface Mount | Ground Fixed | | | |
| Bercy Seat Composite | 2135 | 415 | 83 | Treated Hardwood | Steel | PC Any Standard RAL or Sable Colour | ■ | ■ | ■ | T or DT | 4 | £1240 |
| Bercy Seat | 2135 | 415 | 51 | Steel | Steel | PC Any Standard RAL or Sable Colour | ■ | ■ | ■ | T or DT | 4 | £925 |
| Bercy Bench | 2135 | 415 | 83 | Steel | Steel | PC Any Standard RAL or Sable Colour | ■ | ■ | ■ | T or DT | 4 | £590 |

RENDEZVOUS CITY CURVED BENCH

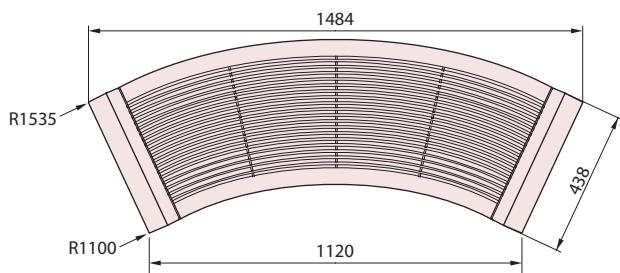

Rendezvous City:

- Features contemporary designs with modern clean lines in steel. City seats and benches offer functionality, solidity and durability with maximum style.
- Seats and backrests are constructed from steel sections which are cleaned, shot blasted and then coated with a base layer of epoxy powder and finished with a polyester powder paint.
- Legs are manufactured from either steel which is treated as above or from cast iron which is treated against rust and polyester powder coated.
- **Colours:** A full range of standard RAL (high gloss) or Sable (matt textured) colours are available. For further information, please see page 427.

RENDEZVOUS CITY SEAT

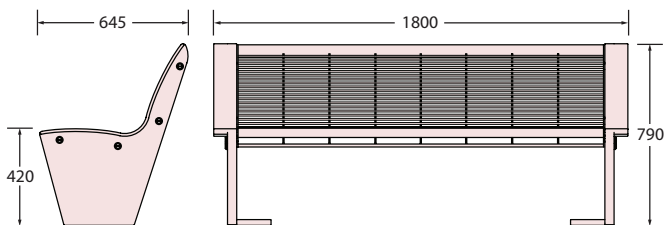
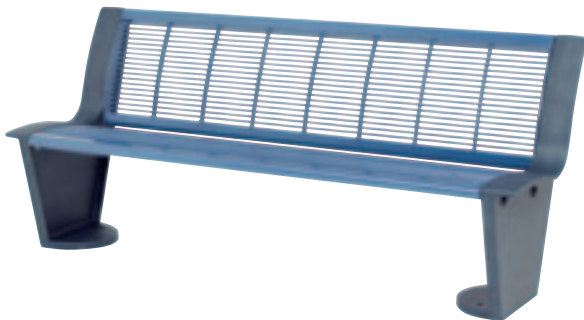

RENDEZVOUS CITY BENCH

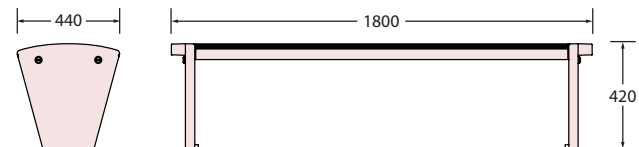
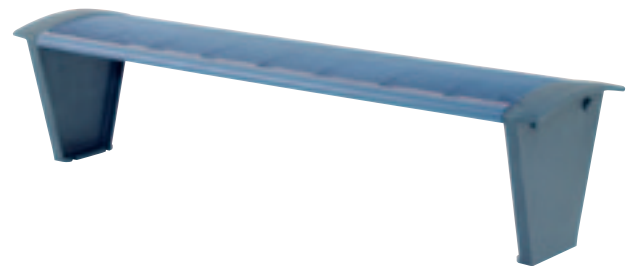

| Product Description | Seat Span (mm) | Seat Height (mm) | Weight (kg) | Seating Section | Seating Ends/Frames | Standard Finish | Fixing Method | | | | Number Required | Guide Price |
|------------------------------|----------------|------------------|-------------|-----------------|---------------------|-------------------------------------|---------------|---------------|--------------|-------------|-----------------|-------------|
| | | | | | | | Free Standing | Surface Mount | Ground Fixed | Fixing Type | | |
| Rendezvous City Seat | 1800 | 420 | 100 | Steel | Cast Iron | PC Any Standard RAL or Sable Colour | ■ | ■ | ■ | T or DT | 4 | £690 |
| Rendezvous City Bench | 1800 | 420 | 51 | Steel | Cast Iron | PC Any Standard RAL or Sable Colour | ■ | ■ | ■ | T or DT | 4 | £1350 |
| Rendezvous City Curved Bench | 1484 | 420 | 51 | Steel | Cast Iron | PC Any Standard RAL or Sable Colour | ■ | ■ | ■ | T or DT | 4 | £1800 |

Steel and Stainless Steel Seating

Urban



Trio Seat, Stainless Steel, Sunderland



Trio Seat, Steel Green, Sunderland

- The Urban range has been designed as a full system for the enhancement of highly urbanised spaces and transport systems. It is composed exclusively of individual seats that can be used independently or as a system.
- Seating is available in either steel or stainless steel. Steel furniture is zinc-plated and powder coated to a high quality finish and is available in a range of RAL (high gloss) or Sable (matt textured) colours. For additional information on colour availability, please turn to page 425. Stainless steel furniture is made from high quality 316L grade stainless steel and is shot peened to give a smooth matt finish.
- Seats can include end and/or intermediate armrests.
- A four or five seat configuration is also available.
- Solo seating can be supplied with either a wall or wall top fixing.
- Supplied with base plate or ground fixing with a standard root depth of 390mm.
- Armrests can be supplied on request.



Solo Seat, Steel Green, Sunderland

TRIO SEAT

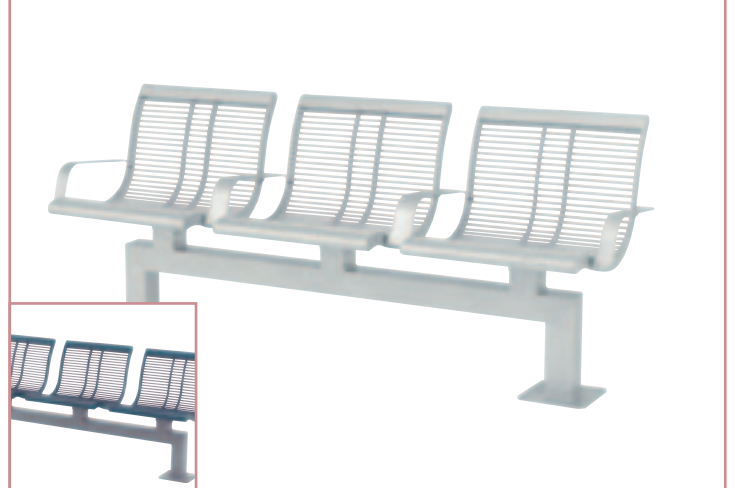

Also Available in Steel

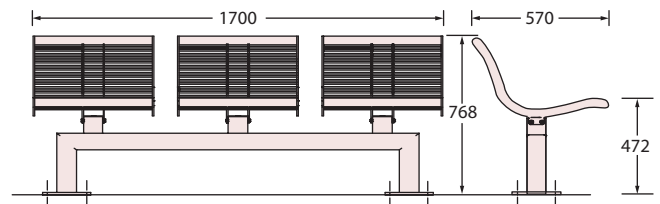

DUO SEAT



Also Available in Steel

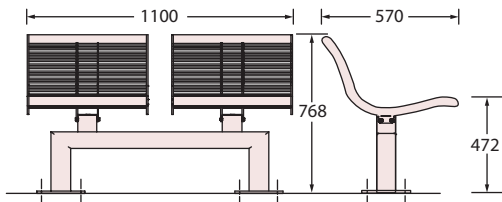

SOLO SEAT



Also Available in Steel

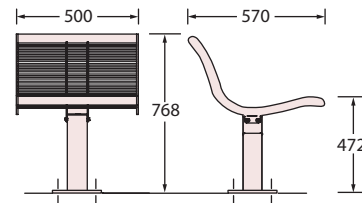

| Product Description | Seat Span (mm) | Seat Height (mm) | Weight (kg) | Standard Finish | Surface Mount | Fixing Method | | | Guide Price* | |
|---------------------|----------------|------------------|-------------|--------------------------|---------------|---------------|--------------|-----------|--------------|-----------------|
| | | | | | | Ground Fixed | Wall Mounted | Arm Rests | Steel | Stainless Steel |
| Trio Seat | 1700 | 472 | 46 | PC Steel/Stainless Steel | ■ | ■ | | ■ | £1195 | £2450 |
| Duo Seat | 1100 | 472 | 55 | PC Steel/Stainless Steel | ■ | ■ | | ■ | £616 | £1566 |
| Solo Seat | 500 | 472 | 19 | PC Steel/Stainless Steel | ■ | ■ | ■ | ■ | £357 | £843 |

*Prices shown for root fixing and exclude armrest option. For other alternatives contact sales order office.

Steel and Stainless Steel Seating

Station

OLLERTON



STATION SEAT

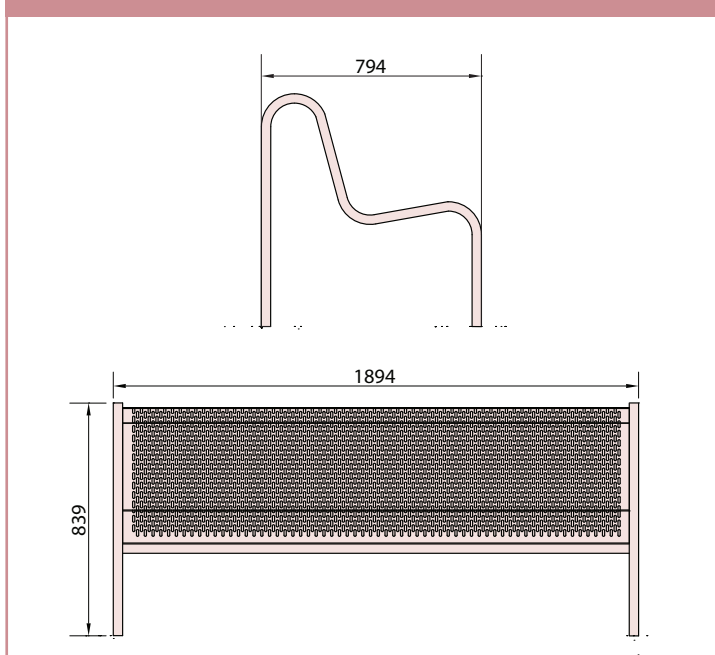

- Designed with crowded train and bus stations in mind, the Station seat is designed to ease the density and stress of travellers when commuting to work, business or leisure trips. Whatever the loads carried, the Station seat will offer comfort and tranquility to all commuters on a daily basis.
- The seat has a 2mm thick perforated sheet steel seat pan and mild steel CHS ends. It is zinc primer and polyester powder coated and root fixed. The roots are of 250mm height below ground fixed in concrete foundation.
- The seat comes in black as standard. A full range of RAL colours are available to choose from to match the surroundings, information of which can be found under page 425.
- The seat is provided fully assembled for easy site installation.

| Product Description | Seat Span (mm) | Seat Height (mm) | Weight (KG) | Standard Finish | Guide Price |
|---------------------|----------------|------------------|-------------|----------------------|-------------|
| Station Seat | 1894 | 839/250 | 30 | PC in RAL Black 9005 | £375 |



Solo Seat, Steel Green, Sunderland

TRIO SEAT

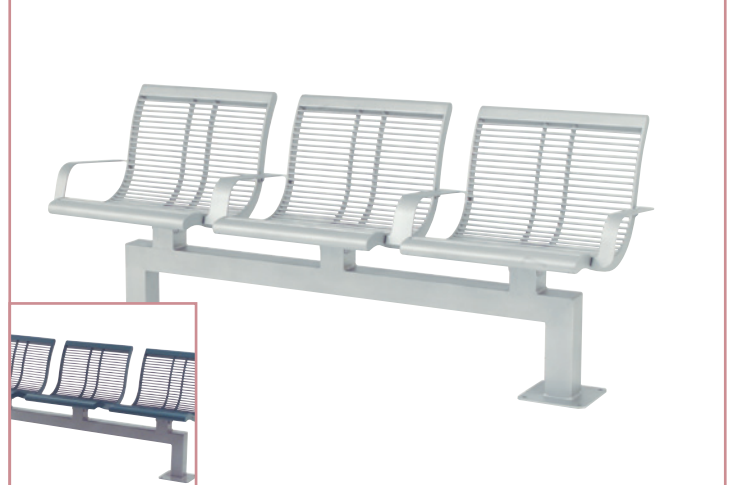

Also Available in Steel

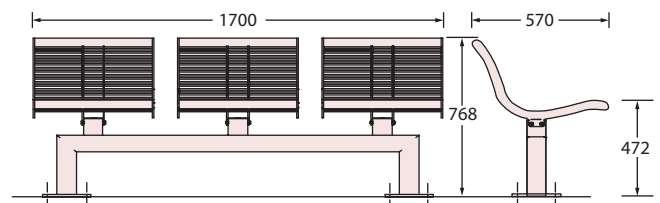

DUO SEAT



Also Available in Steel

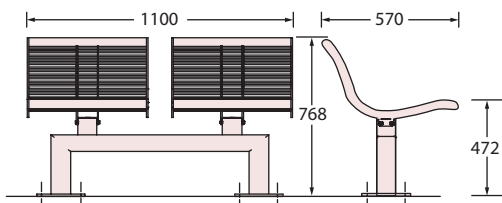

SOLO SEAT



Also Available in Steel

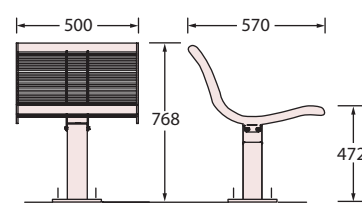

| Product Description | Seat Span (mm) | Seat Height (mm) | Weight (kg) | Standard Finish | Fixing Method | | | | Guide Price* | |
|---------------------|----------------|------------------|-------------|--------------------------|---------------|--------------|--------------|-----------|--------------|-----------------|
| | | | | | Surface Mount | Ground Fixed | Wall Mounted | Arm Rests | Steel | Stainless Steel |
| Trio Seat | 1700 | 472 | 46 | PC Steel/Stainless Steel | ■ | ■ | | ■ | £1195 | £2450 |
| Duo Seat | 1100 | 472 | 55 | PC Steel/Stainless Steel | ■ | ■ | | ■ | £616 | £1566 |
| Solo Seat | 500 | 472 | 19 | PC Steel/Stainless Steel | ■ | ■ | ■ | ■ | £357 | £843 |

*Prices shown for root fixing and exclude armrest option. For other alternatives contact sales order office.