

Slot diffuser

- Type VSD35
- with 35 mm wide slot

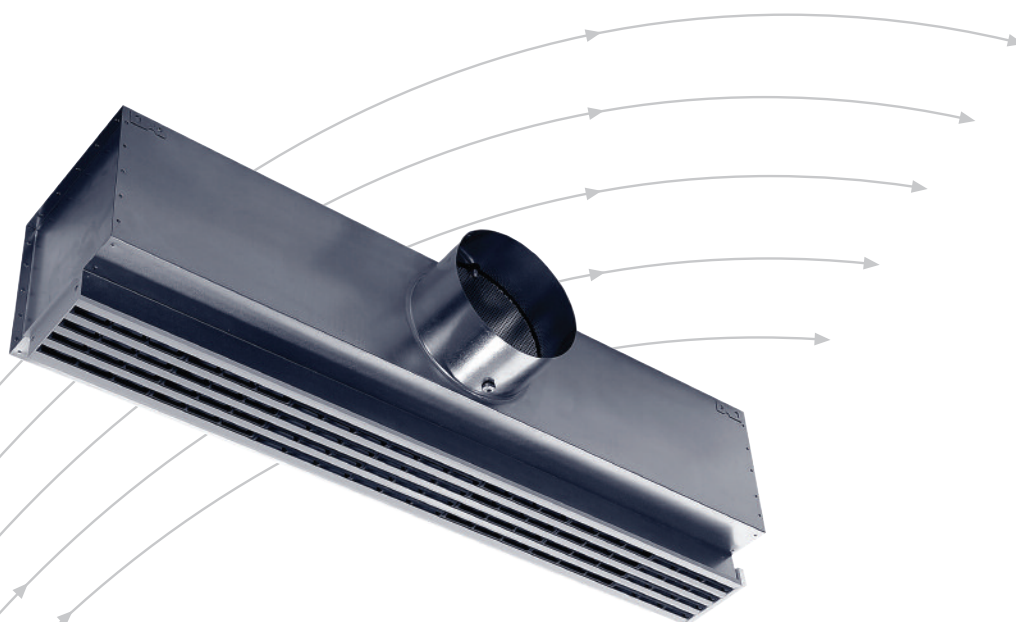

TROX[®] TECHNİK

TROX UK Ltd
Caxton Way
Thetford
Norfolk IP24 3SQ

Telephone +44 (0) 1842 754545
Telefax +44 (0) 1842 763051
e-mail trox@troxuk.co.uk
www.troxuk.co.uk

Contents · Air Diffuser Discharge

Air Diffuser Discharge	2	Acoustic Data: Spectra	9
Description	3	Acoustic Data	10
Construction · Dimensions	4	Aerodynamic Data	12
Installation Details	7	Order Details	16
Nomenclature	8		

**Air Discharge
Horizontal Right**

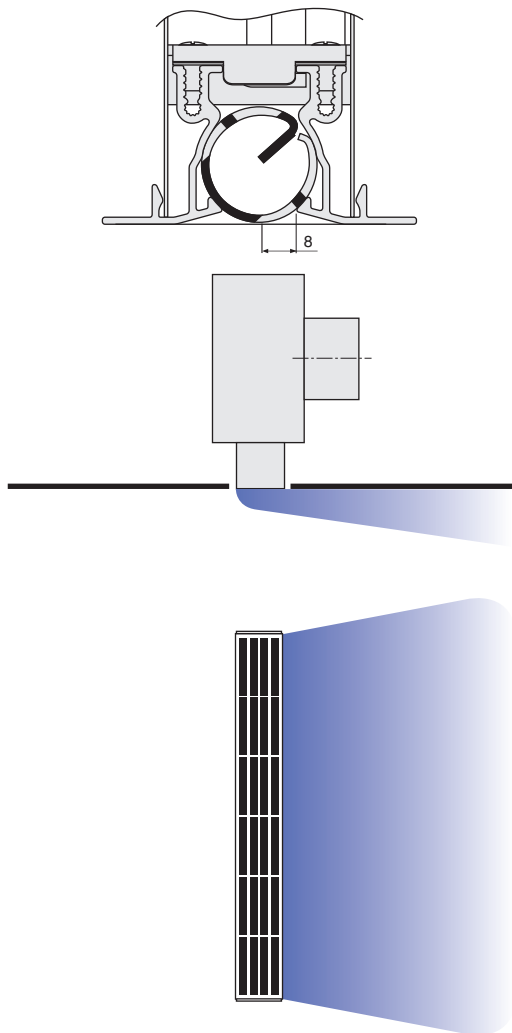

**Air Discharge
Horizontal Left**

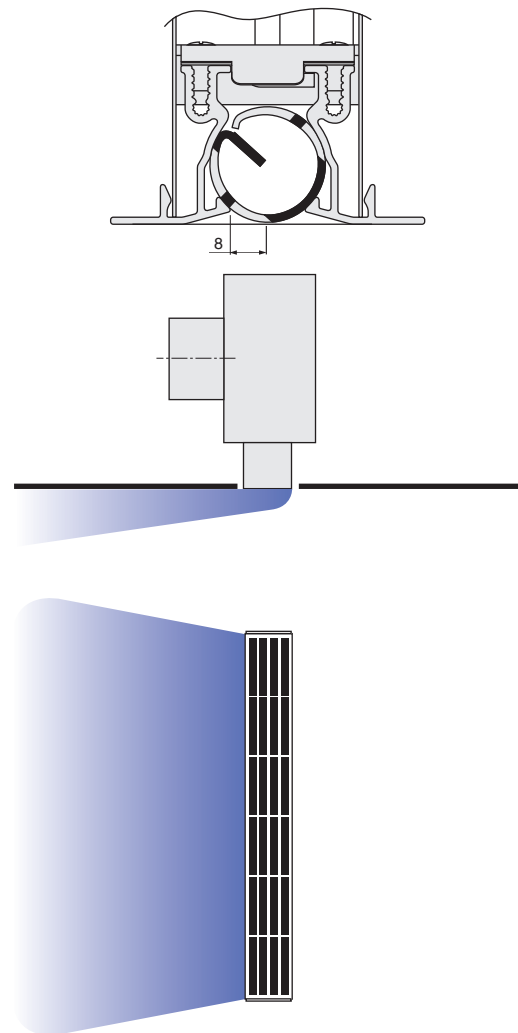

Description · Air Diffuser Discharge

The type VSD35 slot diffuser is available with 1-4 slots, it can be used in rooms with ceiling heights from approx. 2.60 m to 4.00 m. The low overall height means that the slot diffusers are particularly suitable for use in restricted ceiling voids and in suspended ceiling systems. They are characterised by high induction, which results in a rapid decay of supply air velocity and temperature differential.

The recommended supply air temperature differential range is ± 10 K. Because of their stable discharge characteristics, the slot diffusers are suitable for use in systems with constant or variable volume air flows.

The direction of air discharge can be adapted to the required room conditions. The air control blades are set to the customer's requirements as stated on the order. If the discharge direction(s) have to be subsequently changed, this can easily be done on site by rotating the air control blades.

**Air Discharge
Alternating Angled**

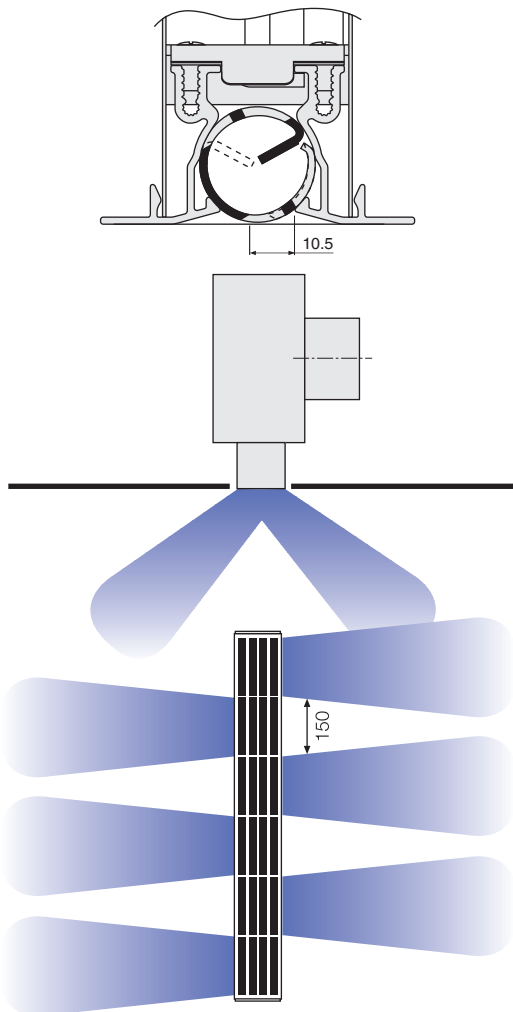

**Air Discharge
Alternating Horizontal**

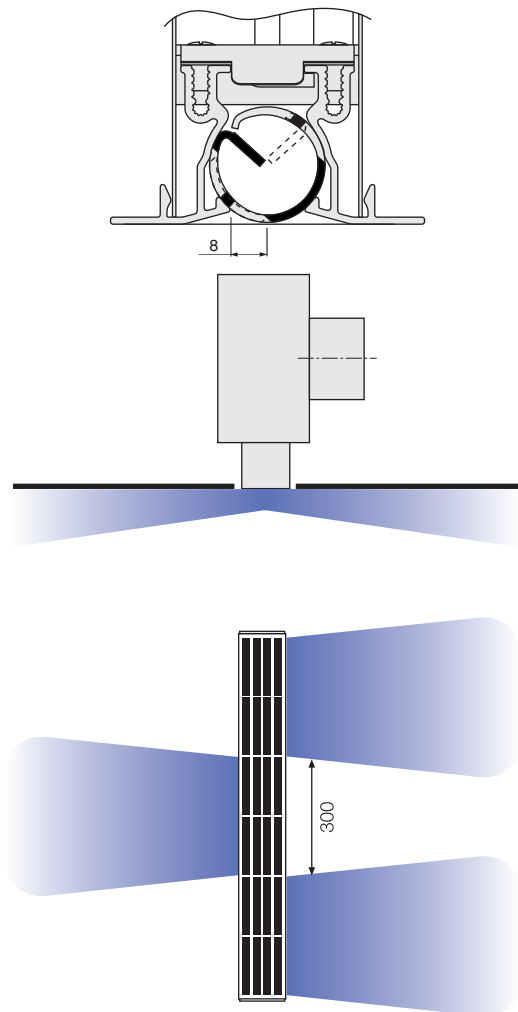

Construction · Dimensions

		AKV-VSD35 plenum details		AKV-VSD35 extended height plenum details	
Slots	Ø D	W	B	W	B
1	98, 123, 148,	138	36.8	87	36.8
2	158, 198, 248,	176	63.6	114	63.6
3	298, 313, 348	214	90.4	140	90.4
4		254	117	167	117.2

AKV-VSD35

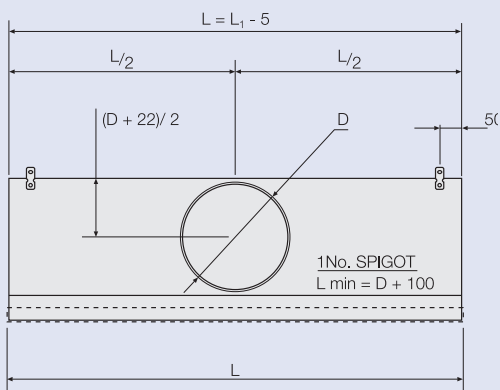

Plenum Length L - 300mm to 1500mm
(150mm increments)

AKV-VSD35

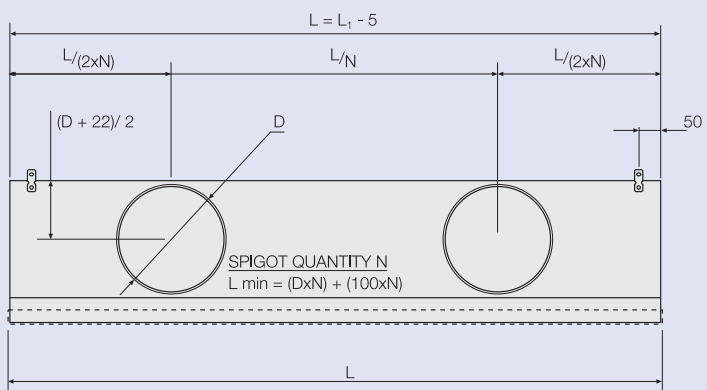

Plenum Length L - 1650, 1800 (2 Spigots)

AKV-VSD...M/

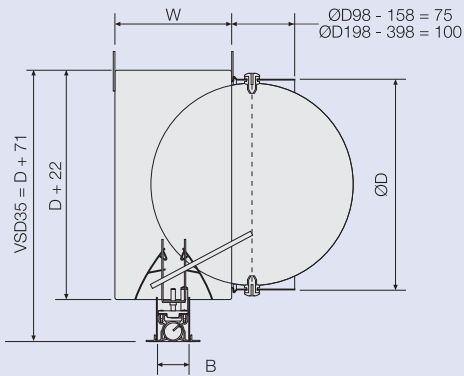

Plenum to slot fixing detail

AKV-VSD...D12-O/

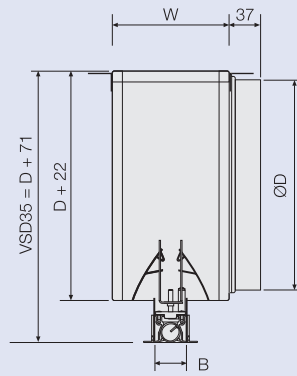

Slot installed in board detail

Extended Height Plenum

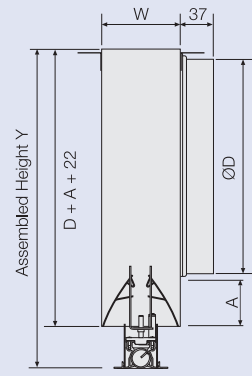

Assembled Height Y = VSD35 (D + A + 71)
Extension A = 125, 150, 200

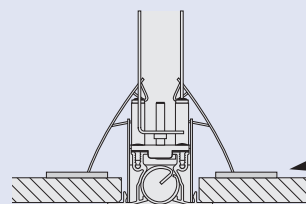
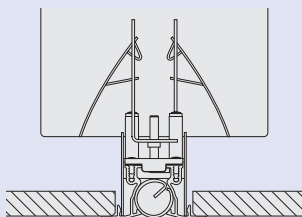

NOTE: Suitable support battens (by others) should be used at each spring clip location to distribute the weight of the diffuser and to prevent penetration of the substrate.

Minimum Board Thickness
VSD35 = 12.5mm

Construction · Dimensions

Slot Width Dimensions VSD35				
Slots	'P'			
	FL	NF	PL	TZ
1	64	44	-	-
2	91	71	-	-
3	118	98	-	133
4	144.5	124.5	299	-
O/A Height	37*	37*	37*	37*

*Overall height excludes 'FK' fixing kit

Tolerance Length 'L₁' +/- 1
Width 'P' +/- 1

VSD35 slot diffusers are supplied separate from the plenum box which is fitted to the rear of the diffuser on site by others. Lined plenums are available as an option. The supply air is connected via the circular side entry spigot which is optionally available with a volume control damper. The face sections are available without flanges type NF or with integral edge flanges type FL, or with flange profiles types PL or TZ to suit various ceiling requirements. Matching end caps are available for the diffuser faces, in the form of end angles or end plates. The alignment pins used at the joints are also included in the scope of supply, to enable the alignment and interconnection of individual L₁ sections. Mitre corners pieces are for aesthetic reasons not fitted with air control blades.

NF = No Flange. The flangeless VSD slot diffuser is suited to installing in apertures in ceiling tiles where the slot diffuser face can sit flush with the tile. It is combined with the L02 end angle for levelling.

FL = Flanged. The flanged VSD can be used to lay on a ceiling T bar or be pulled up and cover an opening in the ceiling.

PL = Plank Ceiling. VSD35 4 slot diffusers with extended flanges to replace a 300mm x 30mm plank ceiling tile. It is combined with the PL02 end angle and edge mounted bracket on each side for levelling.

TZ = Techzone. VSD35 3 slot diffuser to integrate into a 150mm Armstrong Techzone with Microlook 8 edge detail.

Ceiling Integration/Sections

NF

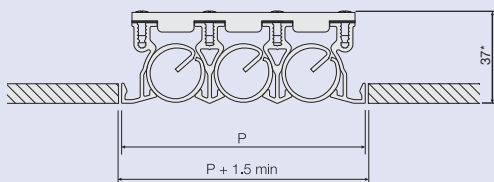

Type 'P' end cap

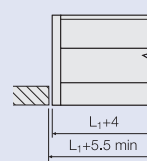

Type 'L' end cap

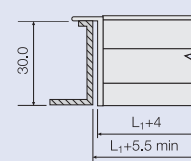

FL

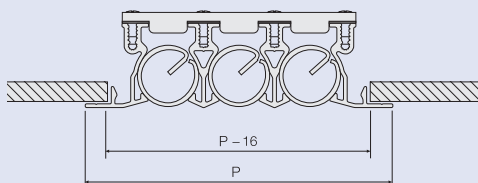

Type 'A' end cap

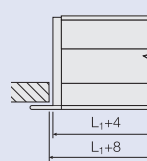

TZ

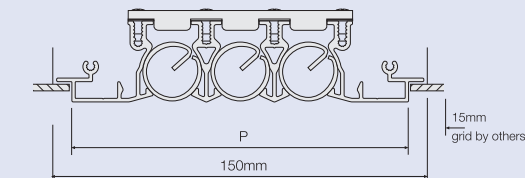

Type 'P' end cap

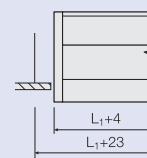

PL

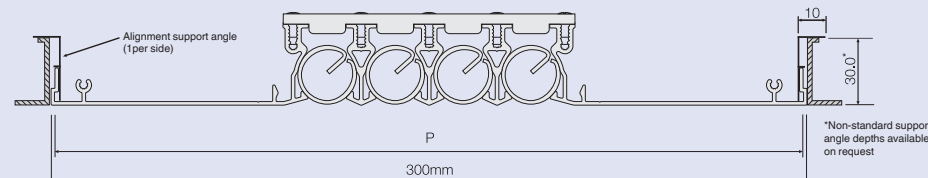

Type 'PL' end cap

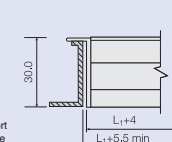

*Non-standard support angle depths available on request

NOTE: 'PL' diffuser type only available as finite section L₁ = 300 min / 1800 max
Must be specified with PL02 (end cap at each end of diffuser).

Construction · Dimensions

End Caps					
End Cap	Description	Border			
		NF	FL	PL	TZ
PO1	'P' type fitted on one end only	✓			
PO2	'P' type fitted on both ends	✓			✓
AO1	'A' type fitted on one end only		✓		
AO2	'A' type fitted on both ends		✓		
LO2	'L' type fitted on both ends	✓			
PL02	'PL' type fitted on both ends			✓	

End Caps

Type P

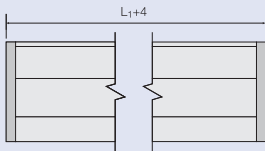

Type A

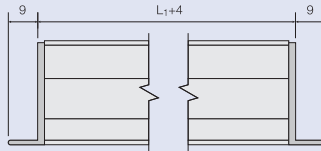

Type L

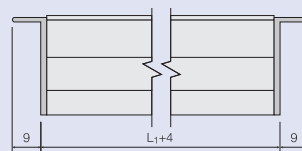

Type PL

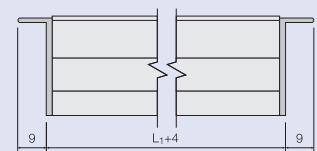

Without end caps ('0')

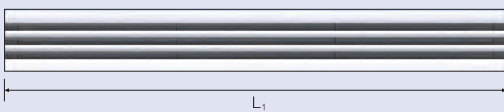

End caps on one end ('XX01')

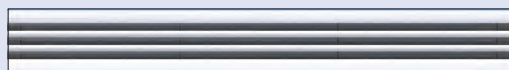

End caps on both ends ('XX02')

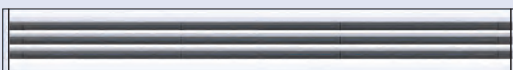

Faceted Ends

Non Standard
E = 300 minimum
Angle = 34° to 89° in 1 degree increments

Tolerance +/- 1°

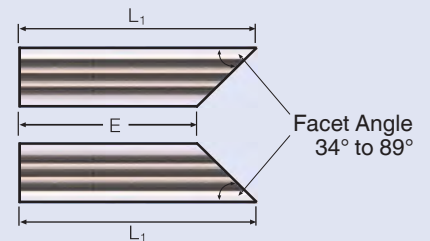

Front face

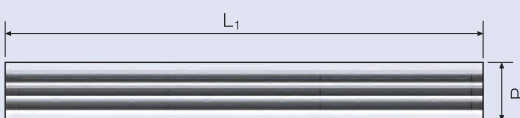

Mitred Corners

Standard
E = 200 : Angle = 90° or 135°
Non Standard
E = 200 : Angle = 68° to 179° in 1 degree increments

Tolerance +/- 1°

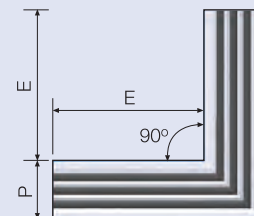

Installation Details

Figure 1

Standard method of installing slot diffuser assemblies is to use the four suspension points on the plenum box. Suitable support rods/wires and fixing accessories by others on site.

Figure 2

If there are linear runs of slot diffusers, the alignment pins supplied can be used to keep the face of the diffuser aligned. The alignment pins (2 per slot) are initially fitted on one side and then inserted approx. halfway into the other section.

Figure 3

Installation spring clip is supplied with 8 pre-set notch positions to suit variable ceiling types. The required notch should be selected on each spring clip prior to installation within the ceiling. NOTE - When used in conjunction with type AKV plenums, notch position 1 should be used.

Figure 4

In order to fit the diffuser to the plenum box, the air control blades below the fixing points must be adjusted so that the screw can be reached with a screw driver. Push the diffuser into the neck of the plenum compressing the spring clips. Once inside the plenum the spring clips will spring out preventing the diffuser from coming out. Then turn the screw so the diffuser pulls up tight into the plenum.

Figure 5

The airflow rate can be adjusted from the front face of the diffuser. To do this, the air control blade below the spigot must be adjusted until the damper can be moved using a screwdriver or round bar (max. dia. 3.5mm, length depending on the neck extension).

Figure 1

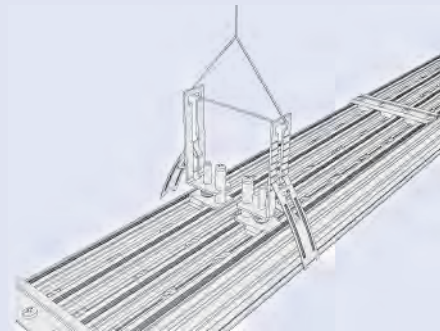
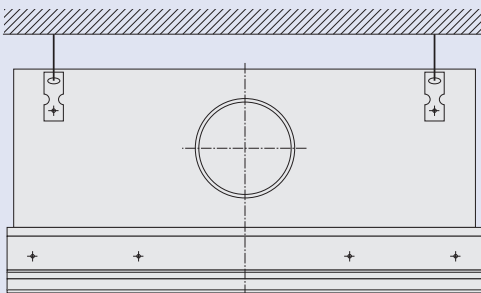

For diffusers without plenums the use of a safety wire by others attached to the slab provides an extra level of safety.

Figure 2

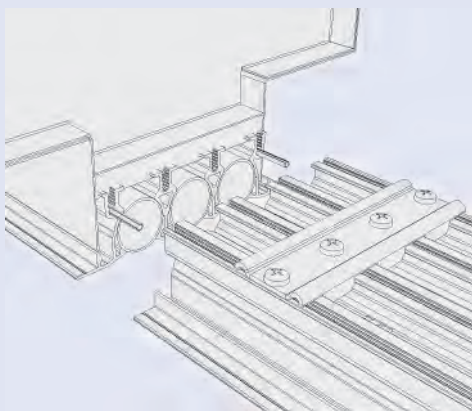
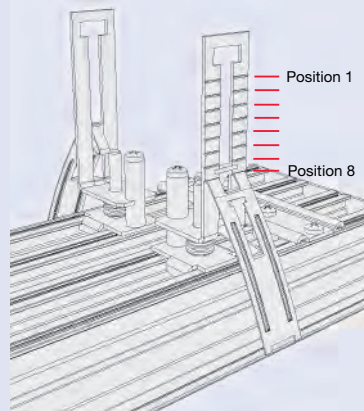

Figure 3



Notch Positions

Notch Position	Min board thickness mm	Max board thickness mm
1	45	52
2	40	47
3	35	42
4	30	37
5	25	32
6	20	27
7	15	22
8	12.5	17

Figure 4

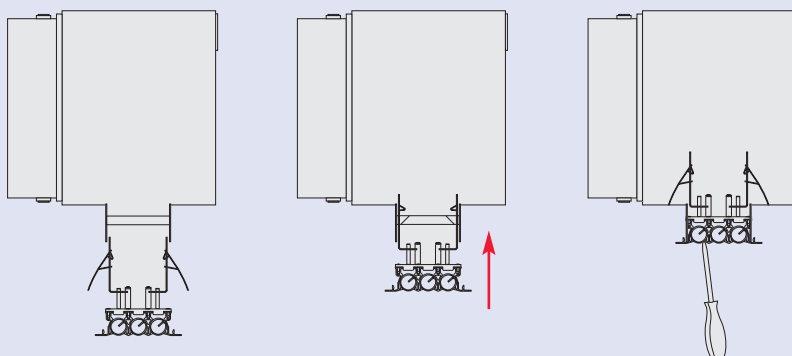
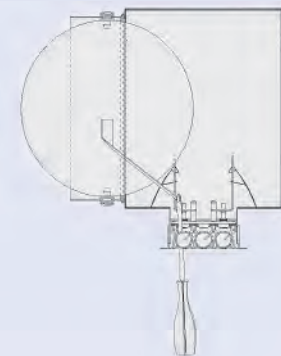

Figure 5



Nomenclature

Nomenclature

\dot{V}	in l/s · m:	Volume flow per unit length
\dot{V}	in m ³ /h · m:	Volume flow per unit length
\dot{V}_t	in l/s:	Total volume flow
\dot{V}_t	in m ³ /h:	Total volume flow
A	in m:	Spacing between two diffusers
H ₁	in m:	Distance between ceiling and occupied zone
H _{1 max}	in m:	Maximum penetration depth when heating
L	in m:	Distance from diffuser L = A/2 + H ₁ or L = X + H ₁
\bar{v}_{H_1}	in m/s:	Time average air velocity between two diffusers at distance H ₁ from ceiling
\bar{v}_L	in m/s:	Time average air velocity at wall at distance L
v _{eff}	in m/s:	Effective jet velocity
Δ t _Z	in K:	Temperature difference between room air and supply air
Δ t _L	in K:	Difference between room temperature and core temperature at distance L
Δ t _{H₁}	in K:	Difference between room temperature and core temperature at distance H ₁
Δ p _t	in Pa:	Total pressure drop
L _{WA}	in dB(A):	A-weighted sound power level
L _{W NC}	:	NC rating of sound power spectrum
L _{W NR}	:	L _{W NR} = L _{W NC} + 2
L _{pA} , L _{pNC}	:	A weighting and NC rating respectively of room sound pressure level
		L _{pA} ≈ L _{WA} - 8 dB
		L _{pNC} ≈ L _{W NC} - 8 dB
Δ L	in dB/oct.:	Relative level with respect to L _{WA}
L _W	in dB/oct.:	Octave band sound power level of regenerated noise L _W = L _{WA} + Δ L

Effective Jet Velocity

\dot{V}_t in l/s

$$v_{\text{eff}} = \frac{\dot{V}_t}{s_{\text{eff}} \cdot L_1 \cdot 1000} \text{ [m/s]}$$

L₁ = Length of slot diffuser in m

\dot{V}_t in m³/h

$$v_{\text{eff}} = \frac{\dot{V}_t}{s_{\text{eff}} \cdot L_1 \cdot 3600} \text{ [m/s]}$$

Effective Slot Width

Air discharge	Horizontal	Angled
s _{eff} in m	0.0062	0.0049

Example

Data given:

VSD35-1; Air discharge alternating, angled

Slot length $L_1 = 1050$ mm

Total volume flow $\dot{V}_t = 25$ l/s

Spigot diameter $D = 98$ mm

Required: Sound power level of regenerated noise L_W

Octave band centre frequency in Hz	63	125	250	500	1000	2000	4000	8000
L_{WA} in dB (A)	29	29	29	29	29	29	29	29
ΔL in dB	3	1	7	-3	-15	-23	-31	-38
L_W in dB	32	30	36	26	14	6	-2	-9

Diagram 1: Sound power and pressure drop

$\Delta p_t = 17 \text{ Pa} \cdot 1.4 \approx 24 \text{ Pa}$

$L_{WA} = 29 \text{ dB(A)}$

Effective jet velocity v_{eff} :

$$v_{\text{eff}} = \frac{\dot{V}_t}{S_{\text{eff}} \cdot L_1 \cdot 1000} = \frac{25}{0.0049 \cdot 1.05 \cdot 1000} = 4.9 \text{ m/s}$$

Relative Spectra ΔL for Damper Angle 0°

Type	Length mm	Effective jet velocity v_{eff} m/s	Octave band centre frequency in Hz								
			63	125	250	500	1000	2000	4000	8000	
VSD35-1	600	2	13	6	6	-6	-28	-42	-45	-50	
			1050	2	7	-10	-30	-43	-46	-52	
			1500	16	8	6	-8	-26	-36	-47	-53
	1050	3	9	5	6	-4	-21	-32	-35	-40	
			1050	11	2	7	-6	-22	-34	-42	-48
			1500	11	6	7	-5	-20	-29	-38	-46
	1500	5	3	2	6	-1	-14	-21	-28	-34	
			1050	3	1	7	-3	-15	-23	-31	-38
			1500	3	2	6	-2	-13	-20	-30	-40
	600	7	-2	0	4	0	-10	-14	-27	-31	
			1050	-3	0	6	-2	-10	-16	-29	-34
			1500	-3	-1	5	-1	-9	-16	-33	-36
VSD35-2	600	2	14	9	5	-5	-24	-33	-37	-42	
			1050	20	7	6	-9	-20	-27	-35	-45
			1500	5	8	7	-5	-18	-26	-37	-47
	1050	3	9	7	6	-3	-18	-26	-30	-36	
			1050	14	6	7	-5	-15	-23	-34	-43
			1500	1	5	7	-3	-14	-22	-36	-43
	1500	5	0	3	6	-1	-11	-19	-27	-33	
			1050	6	3	6	-3	-12	-19	-30	-38
			1500	-5	1	6	-2	-10	-17	-32	-40
	600	7	-6	-1	5	-1	-8	-15	-29	-30	
			1050	-1	0	6	-2	-10	-17	-35	-38
			1500	-10	-2	5	-1	-8	-15	-36	-38
VSD35-3	600	2	10	5	6	-3	-24	-39	-44	-51	
			1050	9	6	7	-7	-16	-28	-38	-48
			1500	11	2	7	-5	-17	-26	-36	-48
	1050	3	5	4	6	-2	-18	-28	-35	-42	
			1050	3	4	7	-5	-13	-23	-36	-45
			1500	5	1	7	-4	-13	-21	-35	-45
	1500	5	-2	1	6	-2	-10	-17	-28	-36	
			1050	-6	0	7	-3	-11	-17	-29	-39
			1500	-3	0	6	-3	-9	-15	-33	-42
	600	7	-8	-2	4	-2	-6	-10	-30	-34	
			1050	-12	-3	6	-2	-9	-14	-32	-36
			1500	-8	-2	5	-3	-7	-12	-36	-40
VSD35-4	600	2	9	6	7	-5	-18	-29	-34	-45	
			1050	13	5	7	-7	-18	-28	-38	-50
			1500	4	3	7	-5	-13	-21	-36	-45
	1050	3	5	5	7	-4	-13	-22	-29	-40	
			1050	5	3	7	-5	-13	-21	-32	-44
			1500	1	2	7	-4	-10	-18	-26	-38
	1500	5	-2	2	6	-4	-7	-15	-28	-36	
			1050	-6	-1	6	-4	-7	-15	-28	-38
			1500	-4	1	6	-3	-7	-14	-26	-35
	600	7	-7	-1	4	-4	-5	-11	-31	-35	
			1050	-14	-4	3	-4	-4	-11	-30	-33
			1500	-8	-1	5	-3	-6	-12	-27	-32

Acoustic Data

Correction to diagram 1: Damper setting							
D = 98 mm		Air discharge horizontal			Air discharge angled		
Damper angle		0°	45°	90°	0°	45°	90°
L ₁ = 600	Δp _t	x 1	x 1.3	x 2.0	x 1.7	x 1.9	x 2.6
L ₁ = 1050	Δp _t	x 1	x 1.3	x 2.6	x 1.4	x 1.7	x 3.0
L ₁ = 1500	Δp _t	x 1	x 1.5	x 3.5	x 1.2	x 1.6	x 3.8
	L _{WA}	-	+3	+5	-	+3	+5
	L _{WNC}	-	+3	+5	-	+4	+6

Correction to diagram 3: Damper setting							
D = 123 mm		Air discharge horizontal			Air discharge angled		
Damper angle		0°	45°	90°	0°	45°	90°
L ₁ = 600	Δp _t	x 1	x 1.3	x 2.4	x 1.7	x 2.0	x 3.4
L ₁ = 1050	Δp _t	x 1	x 1.6	x 3.8	x 1.3	x 1.9	x 4.7
L ₁ = 1500	Δp _t	x 1	x 1.5	x 4.3	x 1.2	x 1.8	x 4.4
	L _{WA}	-	+3	+5	-	+4	+7
	L _{WNC}	-	+4	+6	+1	+5	+8

Correction to diagram 2: Damper setting							
D = 123 mm		Air discharge horizontal			Air discharge angled		
Damper angle		0°	45°	90°	0°	45°	90°
L ₁ = 600	Δp _t	x 1	x 1.1	x 1.6	x 1.8	x 1.9	x 2.3
L ₁ = 1050	Δp _t	x 1	x 1.2	x 2.2	x 1.6	x 1.8	x 2.8
L ₁ = 1500	Δp _t	x 1	x 1.3	x 2.3	x 1.4	x 1.7	x 3.2
	L _{WA}	-	+3	+5	-	+4	+5
	L _{WNC}	-	+4	+6	+1	+5	+6

Correction to diagram 4: Damper setting							
D = 138 mm		Air discharge horizontal			Air discharge angled		
Damper angle		0°	45°	90°	0°	45°	90°
L ₁ = 600	Δp _t	x 1	x 1.3	x 2.4	x 1.5	x 1.8	x 3.4
L ₁ = 1050	Δp _t	x 1	x 1.5	x 4.0	x 1.5	x 1.9	x 5.1
L ₁ = 1500	Δp _t	x 1	x 1.7	x 4.9	x 1.3	x 2.0	x 6.6
	L _{WA}	-	+4	+7	-	+5	+8
	L _{WNC}	-	+4	+6	+1	+5	+8

1 Sound power level and pressure drop VSD35-1; D = 98 mm

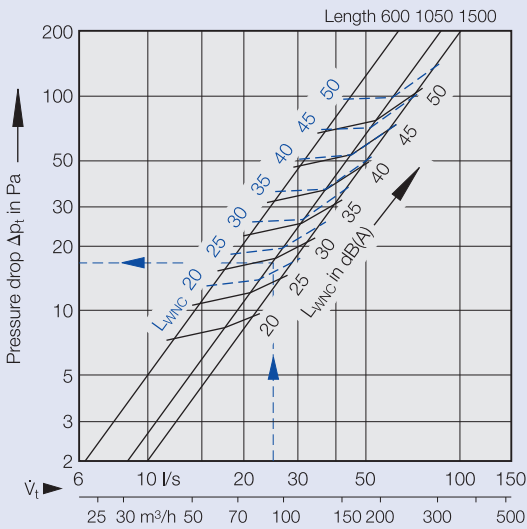

3 Sound power level and pressure drop VSD35-2; D = 123 mm

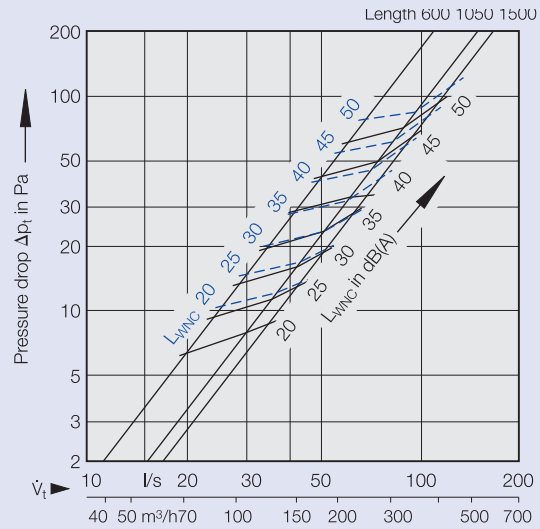

2 Sound power level and pressure drop VSD35-1; D = 123 mm

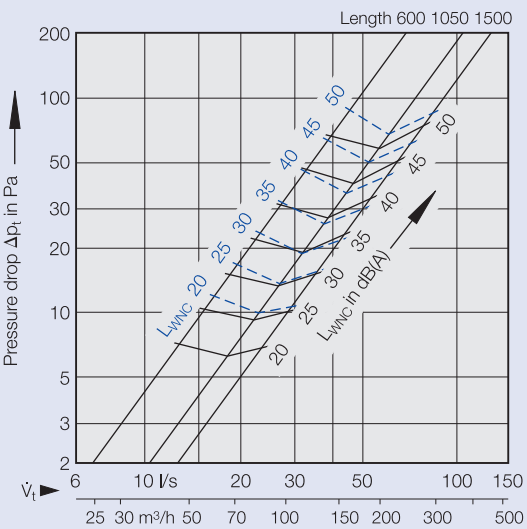

4 Sound power level and pressure drop VSD35-2; D = 138 mm

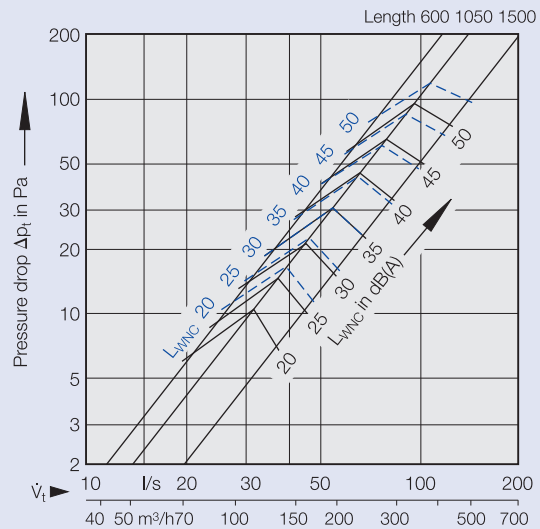

Correction to diagram 5: Damper setting

D = 138 mm		Air discharge horizontal			Air discharge angled		
Damper angle		0°	45°	90°	0°	45°	90°
L ₁ = 600	Δp _t	x 1	x 1.4	x 3.3	x 1.6	x 1.9	x 4.3
L ₁ = 1050	Δp _t	x 1	x 1.7	x 4.9	x 1.3	x 2.0	x 6.1
L ₁ = 1500	Δp _t	x 1	x 1.7	x 4.4	x 1.2	x 1.8	x 6.2
	L _{WA}	-	+4	+6	+1	+5	+7
	L _{WNC}	-	+4	+6	+1	+6	+8

Correction to diagram 7: Damper setting

D = 158 mm		Air discharge horizontal			Air discharge angled		
Damper angle		0°	45°	90°	0°	45°	90°
L ₁ = 600	Δp _t	x 1	x 1.2	x 2.4	x 1.5	x 1.7	x 4.4
L ₁ = 1050	Δp _t	x 1	x 1.9	x 4.0	x 1.2	x 1.8	x 6.7
L ₁ = 1500	Δp _t	x 1	x 1.7	x 4.2	x 1.2	x 2.3	x 7.2
	L _{WA}	-	+4	+6	+1	+5	+7
	L _{WNC}	-	+4	+6	+1	+6	+7

Correction to diagram 6: Damper setting

D = 158 mm		Air discharge horizontal			Air discharge angled		
Damper angle		0°	45°	90°	0°	45°	90°
L ₁ = 600	Δp _t	x 1	x 1.2	x 2.2	x 1.6	x 1.8	x 5.8
L ₁ = 1050	Δp _t	x 1	x 1.5	x 3.2	x 1.4	x 2.2	x 7.4
L ₁ = 1500	Δp _t	x 1	x 1.9	x 4.8	x 1.2	x 2.1	x 9.2
	L _{WA}	-	+3	+6	+1	+5	+8
	L _{WNC}	-	+4	+6	+1	+5	+8

Correction to diagram 8: Damper setting

D = 198 mm		Air discharge horizontal			Air discharge angled		
Damper angle		0°	45°	90°	0°	45°	90°
L ₁ = 600	Δp _t	x 1	x 1.1	x 2.0	x 1.5	x 1.8	x 3.3
L ₁ = 1050	Δp _t	x 1	x 1.4	x 3.2	x 1.2	x 1.7	x 4.7
L ₁ = 1500	Δp _t	x 1	x 1.7	x 4.1	x 1.2	x 2.1	x 6.0
	L _{WA}	-	+3	+5	+1	+5	+6
	L _{WNC}	-	+3	+5	+1	+6	+7

5 Sound power level and pressure drop
VSD35-3; D = 138 mm

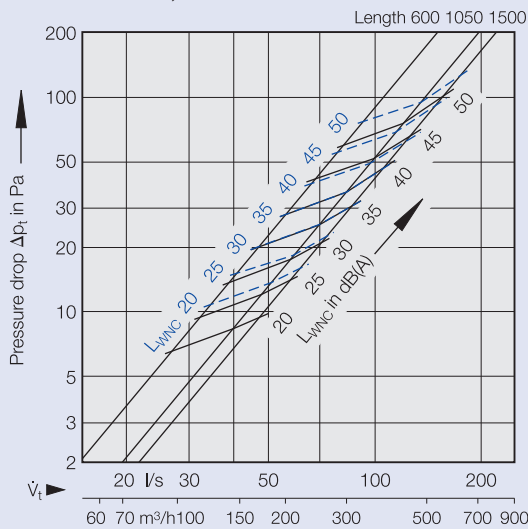

7 Sound power level and pressure drop
VSD35-4; D = 158 mm

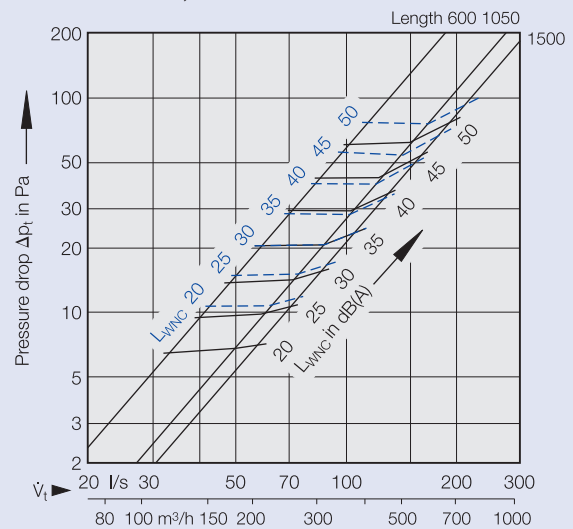

6 Sound power level and pressure drop
VSD35-3; D = 158 mm

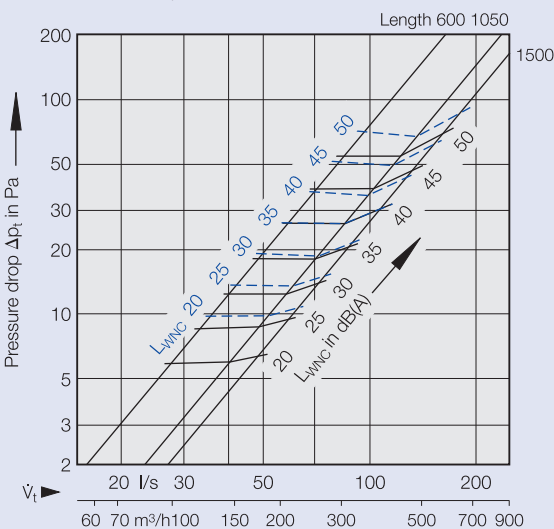

8 Sound power level and pressure drop
VSD35-4; D = 198 mm

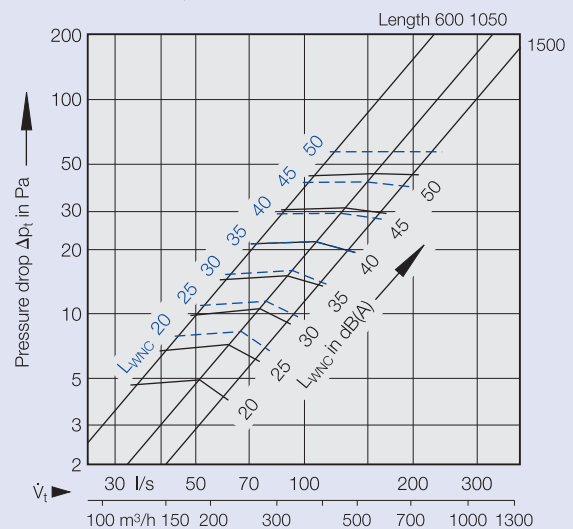

Aerodynamic Data

Air discharge: Horizontal, one or two directions

9 Air velocity between two diffusers and at the wall

$H_1 = 1.0, 1.2, 1.6, 2.0$ m

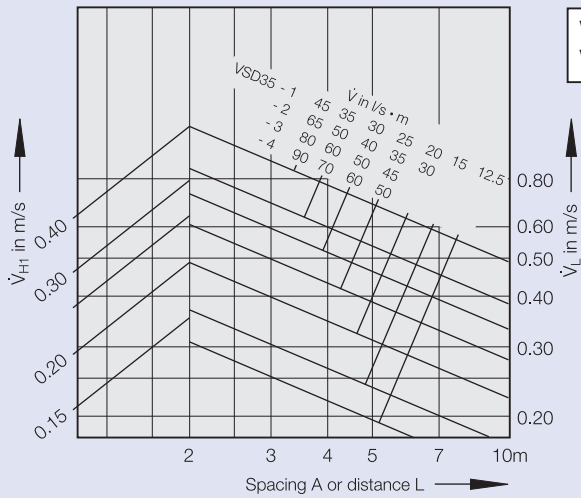

Diffuser Layout

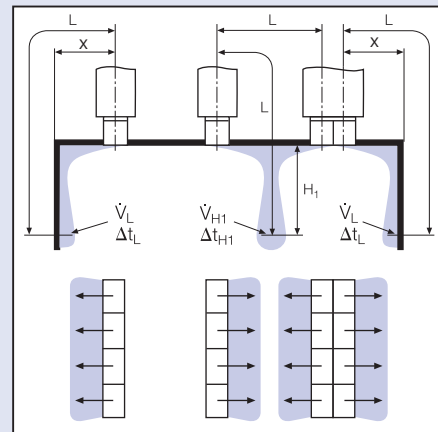

10 Temperature quotient

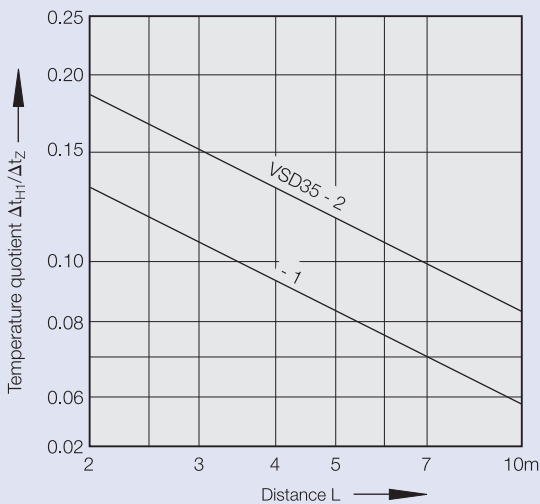

11 Temperature quotient

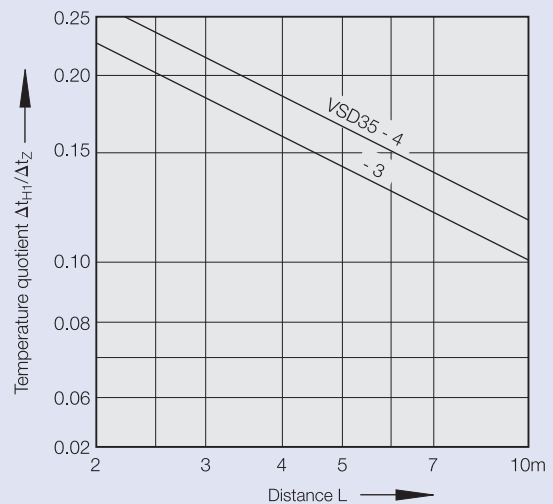

Aerodynamic Data

Air discharge: Alternating horizontal

Example

Data given:

VSD35-1; air discharge: alternating horizontal

Volume flow per unit length $\dot{V} = 30 \text{ l/s} \cdot \text{m}$

Supply air temperature differential
Horizontal, cooling $\Delta t_z = -10 \text{ K}$

Spacing between diffusers $A = 1.8 \text{ m}$

Distance between ceiling
and occupied zone $H_1 = 1.2 \text{ m}$

Distance between diffuser
centre line and wall $X = 2.4 \text{ m}$

Diagram 12:
 $\dot{V}_{H1} = 0.13 \text{ m/s}$

Air velocity between two diffusers

Diagram 13:
 $L = X + H_1 = 2.4 + 1.2 = 3.6 \text{ m}$
 $\dot{V}_L = 0.27 \text{ m/s}$

Air velocity at the wall

Diagram 14:
 $L = A/2 + H_1 = 0.9 + 1.2 = 2.1 \text{ m}$
 $\Delta t_L / \Delta t_z = 0.064$
 $\Delta t_L = 0.064 \times (-10) \text{ K}$
 $\Delta t_L = -0.64 \text{ K}$
For $L = X + H_1 = 3.6 \text{ m}$; $\Delta t_L / \Delta t_z = 0.049$;
 $\Delta t_L \approx -0.5 \text{ K}$

12 Air velocity between two diffusers

$H_1 = 1.0 \ 1.2 \ 1.6 \ 2.0 \text{ m}$

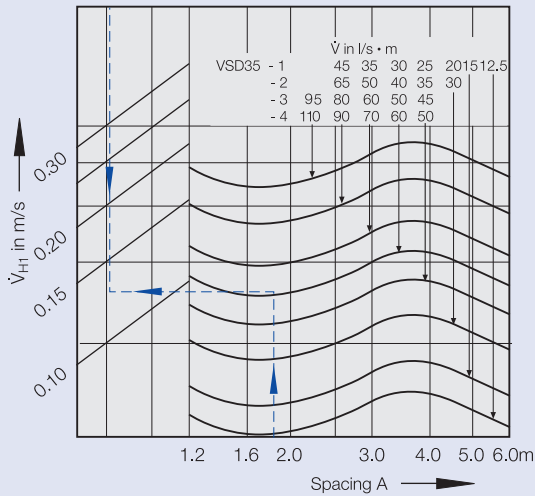

Diffuser Layout

$\dot{V} [\text{m}^3/\text{h}] =$
 $\dot{V} [\text{l/s}] \times 3.6$

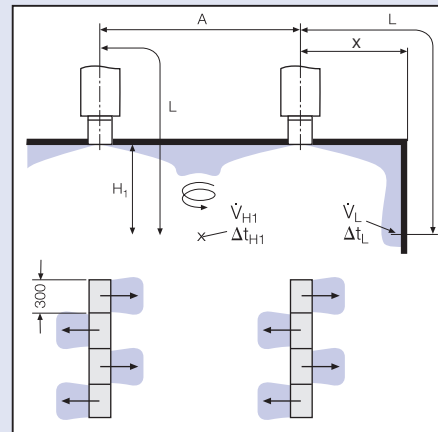

13 Air velocity at the wall

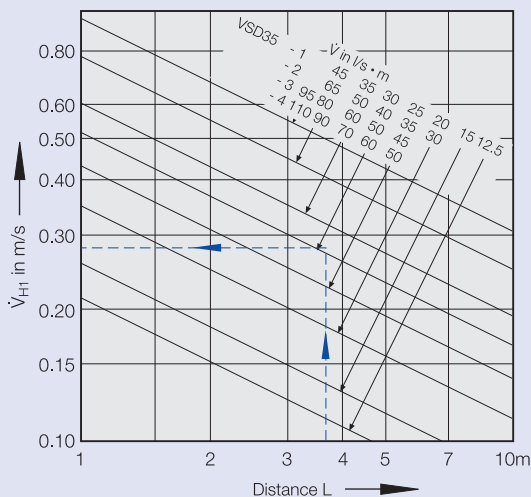

14 Temperature quotient

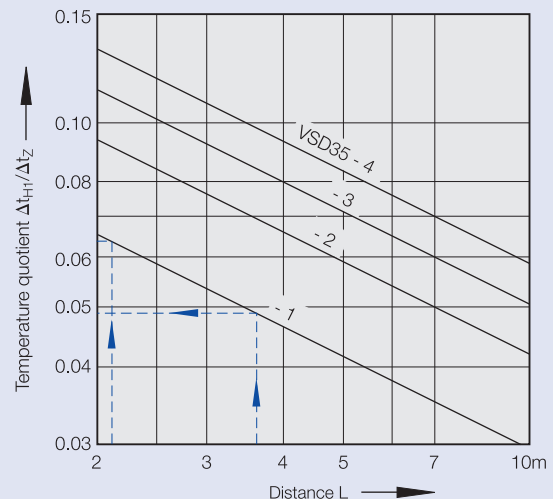

Aerodynamic Data

Air discharge: Alternating angled

Example

Data given:

VSD35-1; air discharge alternating angled

Volume flow per unit length $\dot{V} = 25 \text{ l/s} \cdot \text{m}$

Supply air temperature differential $\Delta t_z = -8 \text{ K}$
approx. $+8 \text{ K}$

Spacing between diffusers $A = 2.4 \text{ m}$

Distance between ceiling and occupied zone $H_1 = 1.0 \text{ m}$

Diagram 15:

$\bar{V}_{H1} = 0.20 \text{ m/s}$

Air velocity between two diffusers

Diagram 17:

$\Delta t_{H1}/\Delta t_z = 0.051$

$\Delta t_{H1} = -0.051 \times (-8 \text{ K}) \approx -0.4 \text{ K}$

For heating $\Delta t_z = +8 \text{ K}$

Temperature quotient, cooling

Diagram 19:

$H_{1\text{max}} \approx 1.5 \text{ m}$

Maximum penetration depth for heating

15 Air velocity between two diffusers

$H_1 = 1.0 \quad 1.2 \quad 1.6 \quad 2.0 \text{ m}$

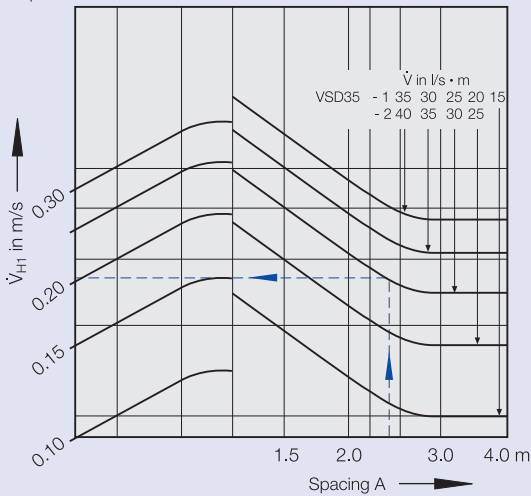

Diffuser Layout

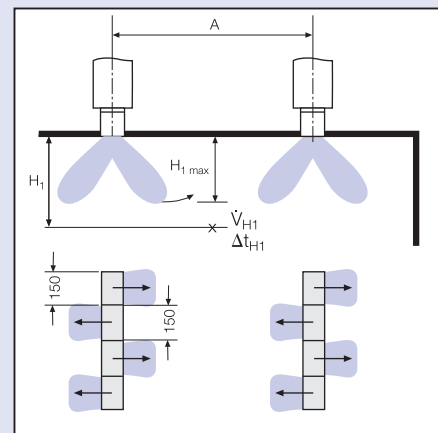

16 Air velocity between two diffusers

$H_1 = 1.0 \quad 2.0 \quad 2.5 \quad 3.0 \text{ m}$

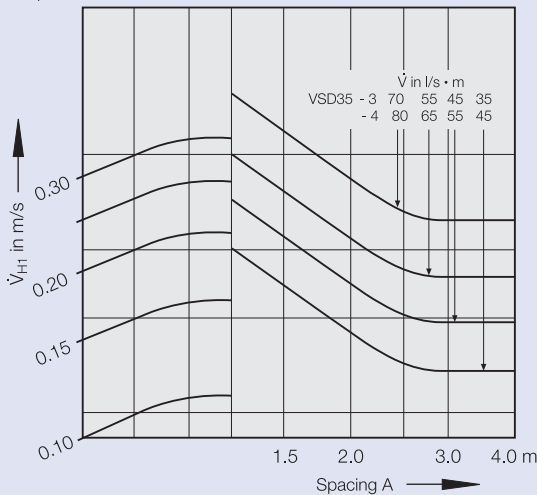

17 Temperature quotient

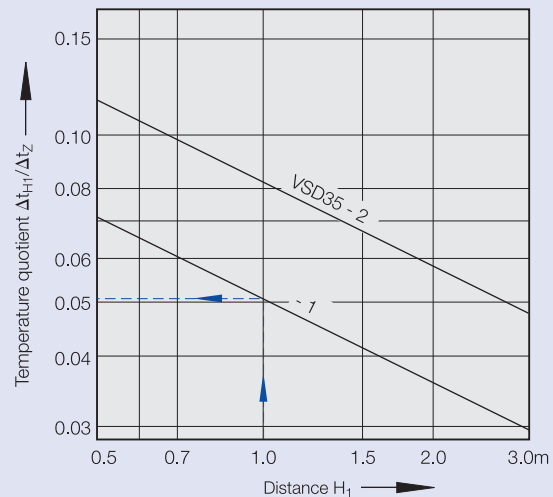

18 Temperature quotient cooling

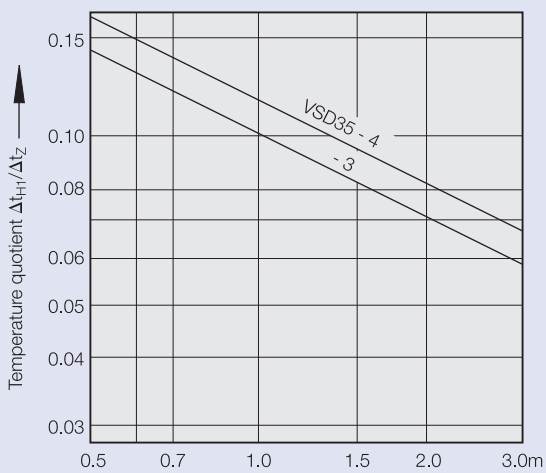

Diffuser Layout

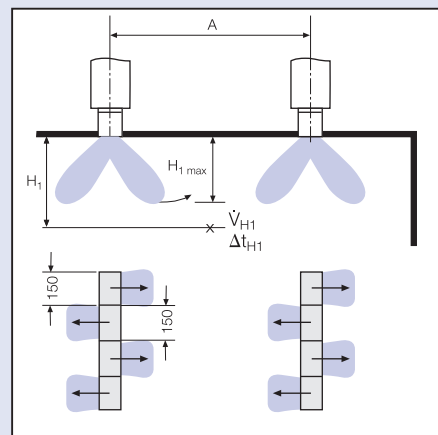

19 Maximum penetration depth, heating

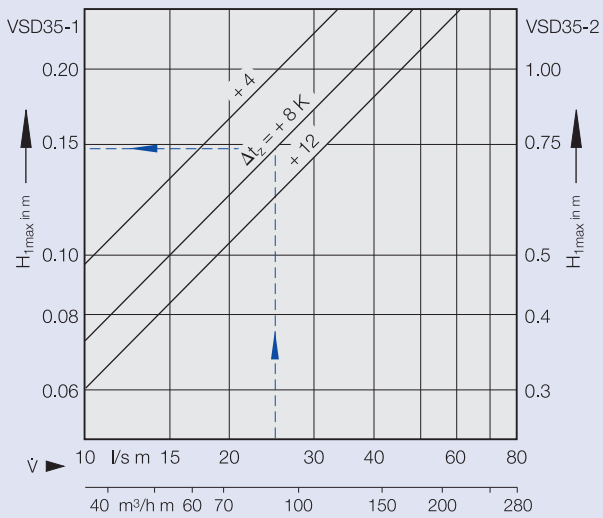

20 Maximum penetration depth, heating

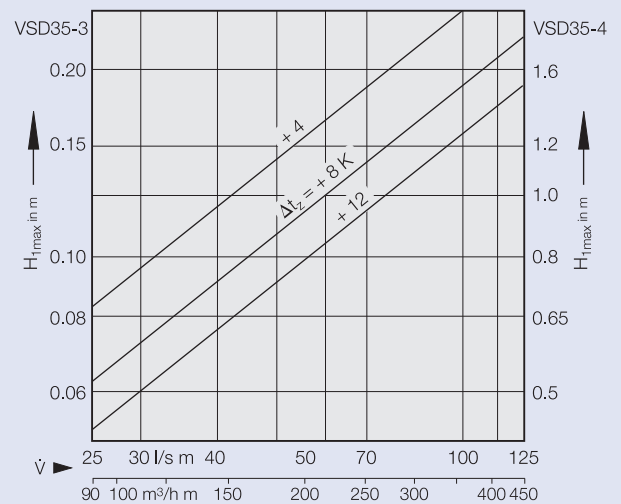

Order Details

Specification

Adjustable slot diffuser with aesthetically designed face section, suitable for installation in suspended ceiling systems, comprising the diffuser face in 1 to 4-slot configuration, optionally without edge flange NF or with integral edge flange FL. End caps either as end plates or end angles, with incorporated air control blades, which are set at the factory but can be adjusted by the user at any time to enable adaptation to the prevailing conditions. The slot diffuser has a variable neck length and the diffuser face can optionally be fitted to the plenum box on site. The plenum box is optionally available with an inner lining of 12 mm in thickness, with circular side entry spigot and four suspension points for suspension of the complete

assembly from the ceiling slab, optionally with volume control damper which is adjustable on the face of the diffuser.

Materials:

Diffuser face and end caps consist of extruded aluminium sections powder coated in RAL colours. The air control blades are produced in black plastic (polystyrene) as standard, similar to RAL 9005, or on request in white (similar to RAL9010). Plenum boxes are from formed pre galvanised sheet steel, optional spigot damper is pre galvanised perforated sheet steel. Plenum boxes can be internally lined with 12mm black faced foam with a class O rating.

Order Code

VSD35-V3-BF-4-FL-A02 / **1200** / **0** / **P3** / **RAL 9010** / **20%** / **HH2**

Type VSD35

Style
 Black White
 BF WF
 BL WL
 BN WN
 BE WE

No. of Slots
 1 to 4

End Cap
 0 = No end plate/angle
 P0X¹ = Plate
 A0X¹ = Angle
 L0X¹ = Offset angle
 PL0X¹ = Plank
¹) where X = 1 or 2

Flange
 NF= Not flanged
 FL = Flanged
 PL = Plank ceiling¹
 TZ = Techzone²
¹) 4 slot only
²) VSD35 3 slot only

Fixings
 0 = Without
 FK = Fixing kit

Length L₁ mm length of diffuser or angle* of mitre in degrees
 *Only in 90° or 135° with 200mm inside leg

Finish/colour
 P3 = powder coated to RAL 9010 20%¹
 P2 = powder coated to RAL 9006 25%
 P4 = powder coated to RAL 9005 20%
 P6 = other colours to RAL
¹) standard finish

Blade Setting
 HH1 = All blades in one direction
 HH2 = Alternating blades every 300mm
 HA2 = 45° Alternating blades every 150mm then 300mm
 HH3 = Alternating blade 33%/66%.
 150mm then 300mm

F=Finite
 L=Linear
 N=Non active
 E=Mitre*

Order Code

AKV-VSD35-V3-0-4-D12-M / **1200 x 1 x 198 x 0** / **269**

Type VSD35

Plenum Type
 0 = Standard Plenum
 EH = Extended Height
 RA = Light baffle return air

No. of Slots
 1 to 4

Lining
 None
 D12 = 12mm

Length
 450mm to 1800mm
 150mm increments

Spigot Damper
 0 = Standard spigot
 M = Spigot damper
 MC = Cord operated spigot damper

Spigot dia

No. of Spigots
 1 to 4

Assembled Height

Extended Height
 A = extension height mm
 0 = without extended neck

Order Example

Make: TROX
 Diffuser Type: VSD35-V3-BF-4-FL-P02/1200/0/P3/RAL9010/20%/HH2
 Plenum Type: AKV-VSD35-V3-0-4-D12-M/1200x1x198x0/0