

easyflush

installation guide

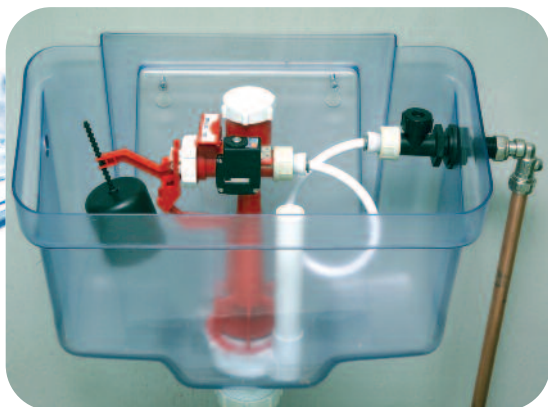

1 Introduction

the **easyflush** valve provides electronic flushing and filling of the WC.

There are two versions to suit different applications:

easyflush wave is operated by the user bringing their hand towards the infrared sensor. The dual flush is standard. A part flush is triggered by a quick hand pass (under 1 second) and a full flush is triggered by a slightly longer hand pass (over 1 second).

easyflush walkaway is activated when the user stands up or leaves the cubicle, but it can also be activated by the user bringing their hand toward the sensor; this function can be disabled by the installer. The dual flush is standard. A part flush is triggered by short user occupancy (under 45 seconds) and a full flush by long user occupancy (over 45 seconds).

supplied parts

- 1 Side inlet
- 2 Bottom inlet
- 3 Outlet
- 4 Inlet washer and nut
- 5 Stem washer with boss
- 6 Stem washer
- 7 Stem nut
- 8 Cap seal
- 9 Cap washer
- 10 Cap nut
- 11 Valve unit
- 12 Float
- 13 Inlet hose
- 14 Sensor unit
- 15 Sensor gasket
- 16 Sensor nut
- 17 Hole adaptor
- 18 Clamp plate
- 19 Screw packer
- 20 Usage label
- 21 Mains adaptor*
- 22 Screws*
- 23 Battery case*
- 24 Sticky pad
- 25 Flush pipe**

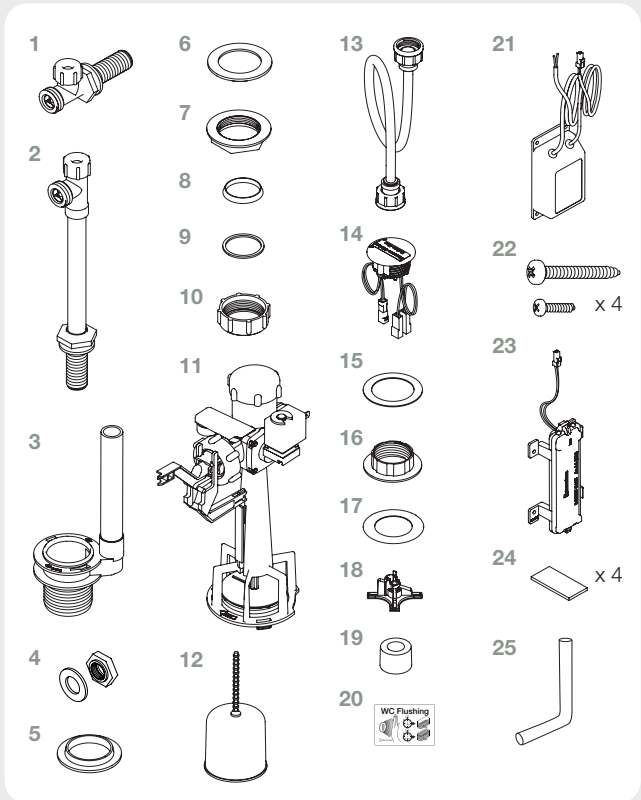

* Where supplied
** When pre-assembled in a cistern

optional extras

- Infrared Configuration Unit (ICU)
- Multi Product Power Supply Unit (PSUC)
- Side Front Adaptor (SFA)

2 Valve operation

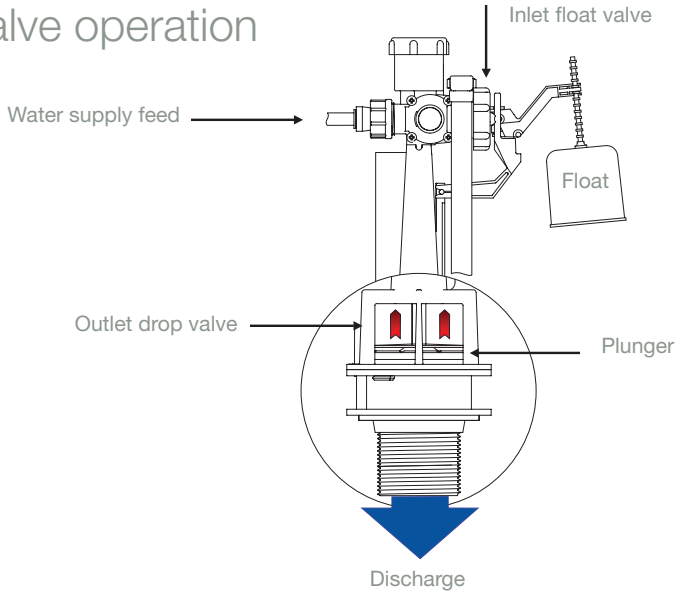

3 Sensor positioning

cistern mounted sensor
(WAVE only)

panel mounted sensor
(WAVE only)

panel mounted sensor
(WALKAWAY only)

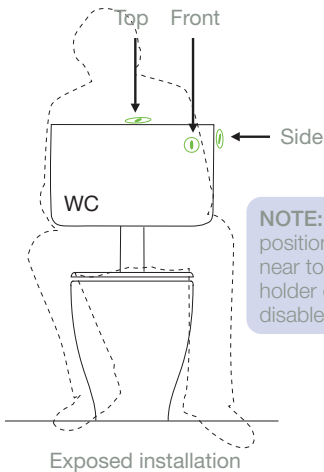

NOTE: Do not position sensor near toilet roll holder or disabled bar.

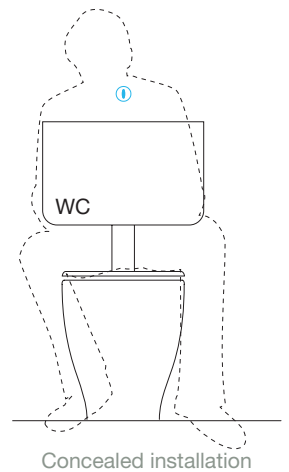
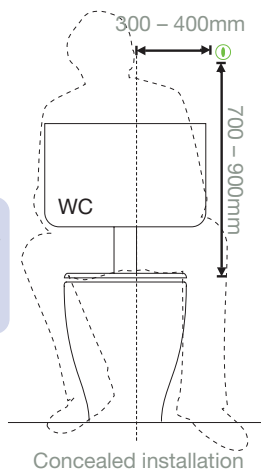

NOTE: Reflective surfaces and materials such as hi-vis jackets may cause the sensor to activate when not expected.

4 Installation schematic

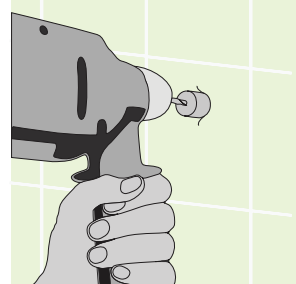
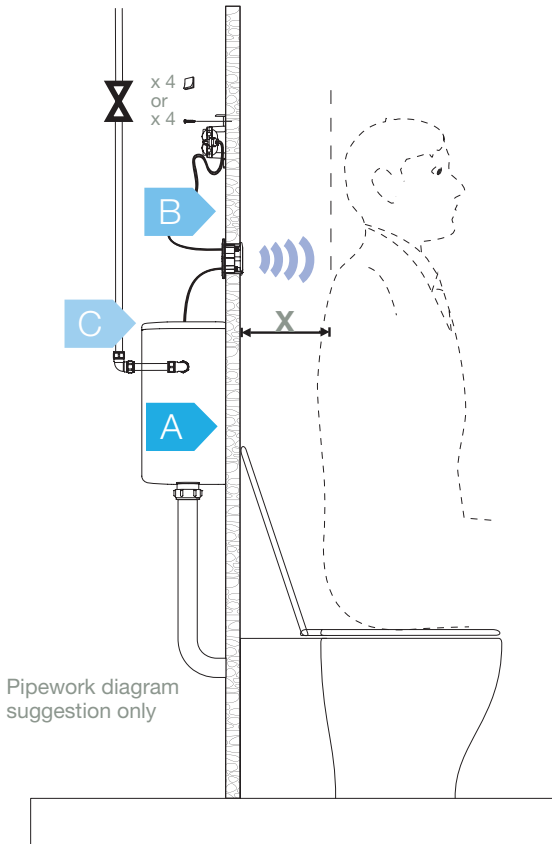

Drill hole to the required diameter.
See **B** for guidance

X – Walkaway version only.
If this distance is less than 12cm
it is recommended that the
Hand Activation is disabled. Refer
to section 10.

NOTE: For chemical water treatment.
If the water system has been treated with chemical dosing,
ensure the system is thoroughly flushed before fitting any
Cistermiser products. Concentrated chemicals in dead
legs can damage the product and result in failure. If the
water is treated with Chlorine Dioxide (ClO₂), ensure
concentration levels are maintained below 5ppm.

A

Valve installation

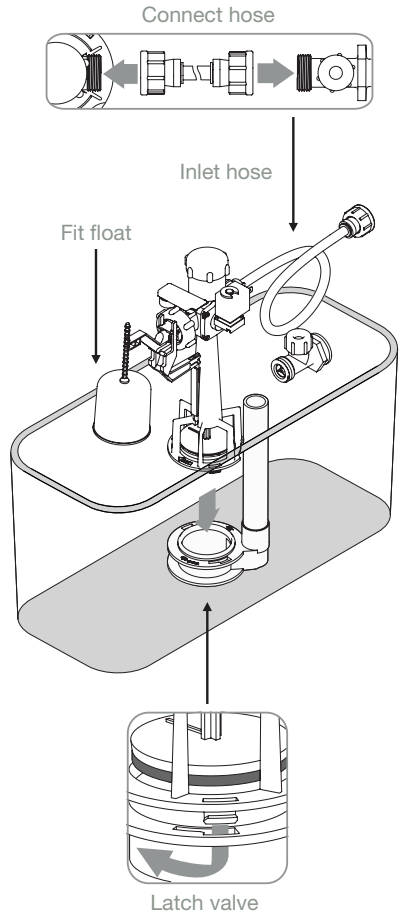
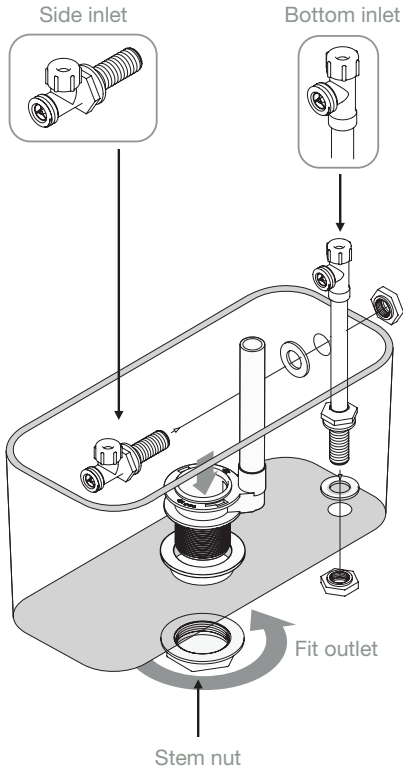

NOTE: For extra narrow cisterns fit outlet & valve pre-fitted together.

B Panel mounted sensor

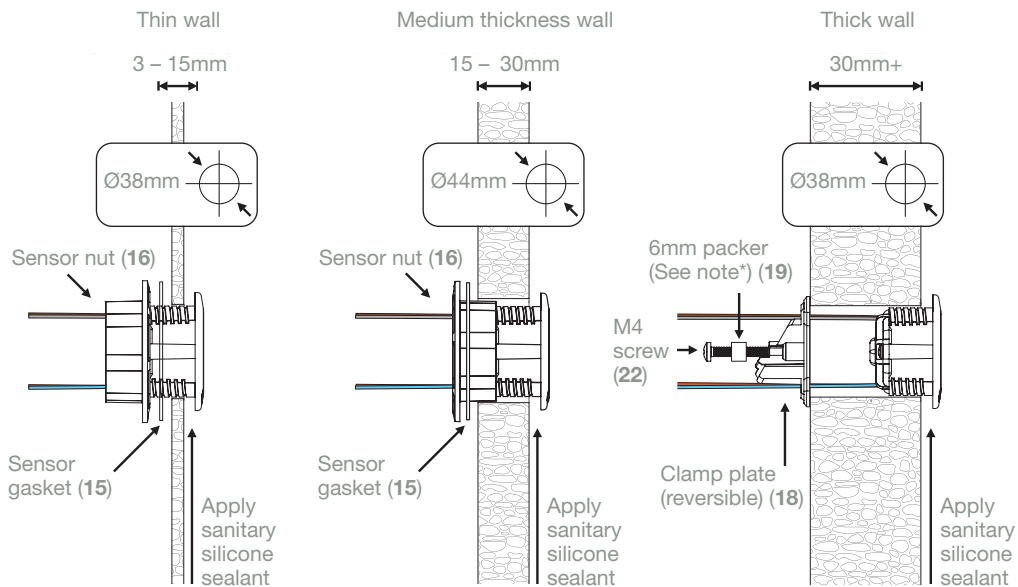

NOTE: *If wall thickness is under 35mm use packer to prevent screw causing damage to sensor

C Cistern mounted sensor – wave version only

Sensor fixing

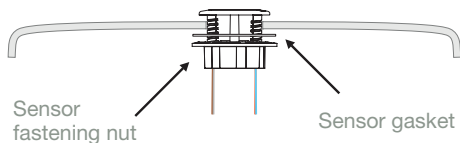

NOTE: Use hole adaptor for holes between 40 and 50mm. A hole diameter larger than 50mm is a non standard installation.

Mounting options

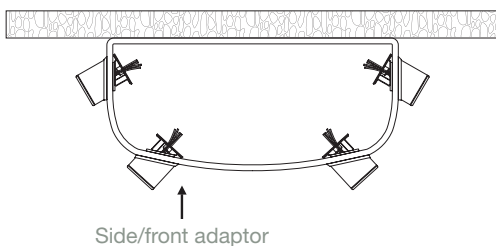

NOTE: Side/front adaptor required.

(Not supplied with standard product but available as an extra. Contact Cistermiser for further details or order on-line at www.cistermiser.co.uk).

5 Power connections

NOTE: Only one power source should be connected at any time, either mains or batteries. It is not possible to connect both simultaneously.

If using the battery case, open it and fit 4 Alkaline AA (LR-6) batteries as indicated. Reseal and fasten into place on panel using screws (22) or with the sticky pads (24). If used in an exposed installation the battery case can be hung inside the cistern by hooking it over the edge.

If using the mains adaptor, fasten into place on panel in a dry location using screws (22) or with the sticky pads (24) and connect the un-terminated mains cable to a 50Hz 230V AC single phase supply via a 1A fused spur (not supplied).

electrical connection

As shown below, connect the spade connectors from the sensor unit to the solenoid prongs taking care to connect the wires according to the colour coding on the label. If these are not long enough they can be extended up to 1 metre.

Connect the power connector from the sensor to the mains adaptor, or in the case of a battery powered installation, the battery case.

NOTE: Remove the lens protection label from the sensor BEFORE connecting to the power. When the power is first connected the LED in the sensor flashes amber. This is normal and lasts only a few seconds.

Colour conventions are brown for positive and grey for negative.

Connections

Sensor valve unit

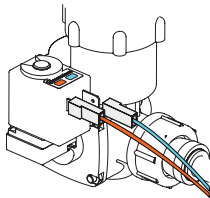

Power connector

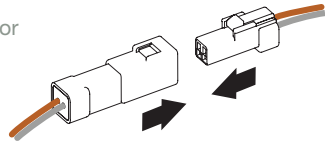

Power options

Battery case requires 4 x AA alkaline batteries

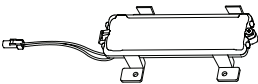

Mains adaptor requires 1A fused spur

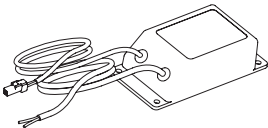

Multi product power supply unit ((Not supplied, contact Cistermiser for further details). Suitable for powering up to 20 units

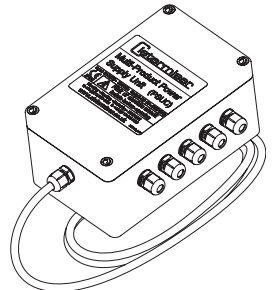

6 Testing and commissioning

Restore the water supply and check all joints and connections for leaks. The cistern will begin filling until the float rises sufficiently to close the water inlet valve.

Check the water level to ensure the cistern fills to the required full flush volume – typically six litres is sufficient – adjust the position of the float if necessary to allow more or less water in for a full flush.

testing operation

NOTE: During installation it is not uncommon for an unexpected flush to occur as a result of a sensor being unintentionally activated during the refill time delay. To check that operation is correct it is important to take the refill time into account.

wave version: Test the installation by placing a hand within 10cm of the sensor for 1 second. The **easyflush** should enter a part flush, lasting 2 seconds (configurable, see section 9 Advanced setting guide). Place a hand within 10cm of the sensor for more than 2 seconds to activate a full flush, lasting 8 seconds. After operating, the **easyflush** will not flush again until the cistern is full, but the **easyflush** does 'remember' attempts to flush. This is called a memory flush.

walkaway version: Same as above to operate **wave** or sit on WC for 6 seconds to activate a part flush, lasting 2 seconds and for more than 45 seconds to activate a full flush, lasting 8 seconds.

explanation of the memory flush (rapid green flashing)

If a second flush is requested whilst the cistern is refilling, the **easyflush** will not flush immediately but will 'remember' the request. The sensor will show a rapid green flashing during this time. After the refill duration (see below) the **easyflush** will flush, completing either a part or full flush as requested.

refill duration setting

It may be necessary for it to be increased or decreased depending on the supply water pressure. The refill duration should be matched to the time it takes the cistern to complete its refill. Follow the Advanced Configuration instructions in section 9.

removal of trapped air from the system

When installing the **easyflush** for the first time air may be trapped in the valve and supply line. This will cause the valve to fluctuate repeatedly between the open and closed positions. To expel air from the system activate the valve by placing a hand in front of the sensor whilst the valve is in this repeating cycle. It may be necessary to do this several times before the action ceases and the valve operates normally.

additional configuration

Additional configuration is possible with an Infrared Configuration Unit (ICU) remote control. (Not supplied; contact Cistermiser). See section 10 for further details.

NOTE: For grey water/rain water harvesting. Ensure adequate filtering is fitted, a 10µm filter is recommended.

NOTE: For chemical water treatment. If the water system has been treated with chemical dosing, ensure the system is thoroughly flushed before fitting any Cistermiser products. Concentrated chemicals in dead legs can damage the product and result in failure. If the water is treated with Chlorine Dioxide (ClO₂), ensure concentration levels are maintained below 5ppm.

7 Usage advice and specification

Minimum working pressure: 0.5 bar dynamic

Maximum working pressure: 6 bar static

NOTE: The **easyflush** is a flush and fill type valve. It uses the incoming water pressure to lift the flush mechanism. At pressures below 0.5 bar dynamic, the valve will not perform as intended.

Back siphonage protection: Class 4 type double check valve – integral in inlet.

factory settings

Range (EF Wave): ~18cm.

Range (EF Walkaway): ~65cm (~9cm for hand activation).

Refill duration after part flush: 48 seconds.

Refill duration after full flush: 80 seconds.

Part flush duration: 2 seconds.

Full flush duration: 8 seconds.

Power requirements: Either 6V from 4 x alkaline AA (LR6) batteries or 6V DC regulated from mains adaptor. (1A fused spur required).

Normal battery life: 2 years under typical usage conditions. A single red flashing of the LED indicates that the batteries are low and need to be replaced.

Cleaning: Clean with soap and water only.

Lens care: Infrared lens can be polished with a soft cloth.

electronic specification

Control classification: Independent.

Maximum load: 7.5W 1.25A (6VDC) EMC emissions tested at load.

Rated temperature range: 0-40°C.

Action classification: Type 1.Y.

Pollution classification: Degree 1.

Ingress protection: IP65.

8 Component dimensions

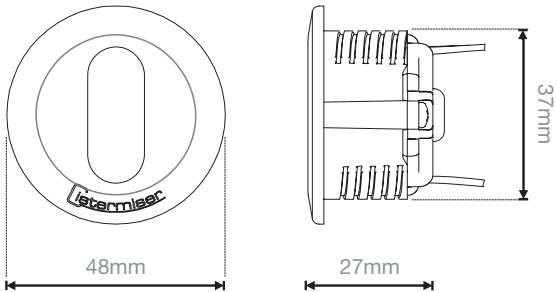
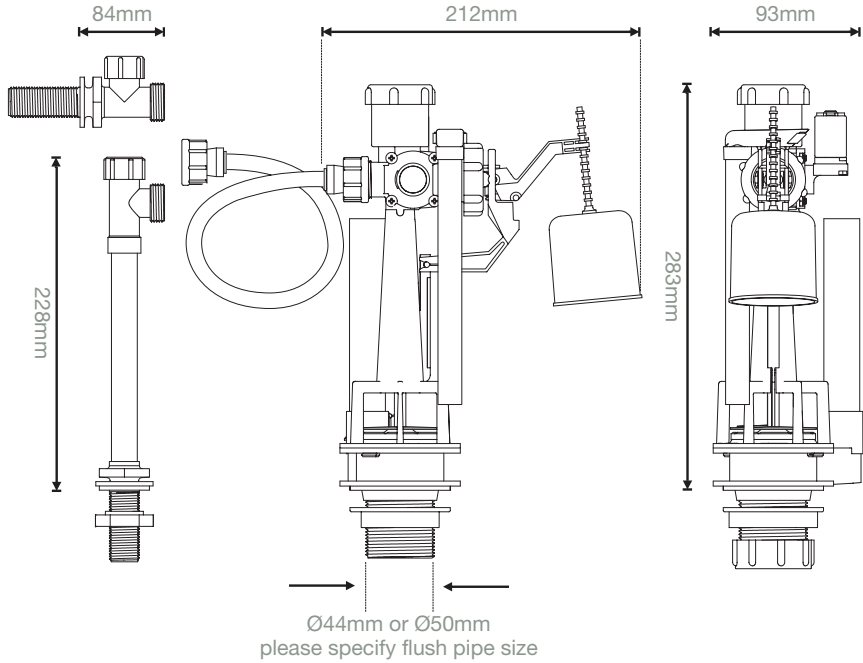

9 Advanced settings guide

easyflush walkaway Carry out only if settings need to be changed

1 Disconnect power, wait for 5 seconds and reconnect.

2 When **flashing amber**.



Place hand 4-6cm from sensor until **constant green**, then remove hand.



3 You are now in configuration mode

If a hand is not placed over the sensor, it will go into normal operation mode.

Sensing range of adjustment

A Wait for **single red flashing** LED to enter sensing range mode.



B Briefly place your hand in front of the sensor until the **green LED flashes slowly**. Range configuration mode will then be ready.

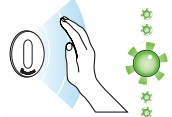

C Stand at the distance from the sensor you would like to set at maximum range. Wait 8 seconds until **constant green** LED shows.

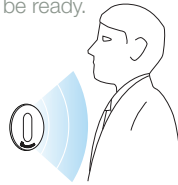

Sensor distance is now set.

Refill duration adjustment

A Wait for **double red flashing** LED to enter refill time.



B During **double red flashing**, briefly place your hand in front of the sensor. The valve will flush and the cistern will refill. A **green flashing** LED will be seen.



C Once the cistern has refilled completely and the water has ceased to flow, move your hand back into the line of sight of the sensor. The refill time has now been set.

Part flush duration adjustment

A Wait for **triple red flashing** LED to enter part flush time mode.



B During the **triple red flashing** briefly place your hand in front of the sensor. The valve will start to flush and a **green flashing** LED will be seen. **HOLD HAND STEADY**.

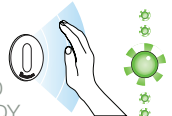

C When the valve has flushed for the desired part flush time, move your hand out of the line of sight of the sensor. The water will cease to flow and the part flush time will be set.

4 After configuration the unit will **flash amber**, giving opportunity to re-enter configuration mode.



easyflush wave Carry out only if settings need to be changed

1 Disconnect power, wait for 5 seconds and reconnect.

2 When **flashing amber**.



Place hand 4-6cm from sensor until **constant green**, then remove hand.



3 You are now in configuration mode

If a hand is not placed over the sensor, it will go into normal operation mode.

Sensing range of adjustment

A Wait for **single red flashing** LED to enter sensing range mode.



B Briefly place your hand in front of the sensor until the **green LED flashes slowly**. Range configuration mode will then be ready.

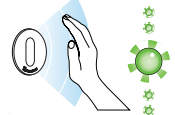

C Move your hand to the distance from the sensor you would like to set as maximum range. Wait 8 seconds until **constant green** LED shows.



Sensor distance is now set.

Refill duration adjustment

A Wait for **double red flashing** LED to enter refill time.



B During **double red flashing** briefly place your hand in front of the sensor. The valve will flush and the cistern will refill. A **green flashing** LED will be seen.

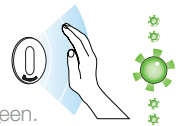

C Once the cistern has refilled completely and the water has ceased to flow, move your hand back into the line of sight of the sensor. The refill time has now been set.

Part flush duration adjustment

A Wait for **triple red flashing** LED to enter part flush time mode.

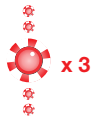

B During the **triple red flashing** briefly place your hand in front of the sensor. The valve will start to flush and a **green flashing** LED will be seen. **HOLD HAND STEADY**.

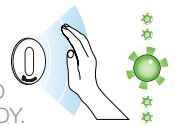

C When the valve has flushed for the desired part flush time, move your hand out of the line of sight of the sensor. The water will cease to flow and the part flush time will be set.

















4 After configuration the unit will **flash amber** giving opportunity to re-enter configuration mode.



10 Infrared Configuration Unit (ICU) guide

NOTE: Not supplied but available from Cistermiser or any major plumbing merchant.

button descriptions

-  Activates cleaning mode
-  Activates ICU configuration mode
-  Decreases setting
-  Increases setting
-  Checks the setting being altered
-  Saves changes and exits ICU configuration mode
-  Quits ICU configuration mode without saving changes
- 1**  Configures sensor range
- 2**  Configures part flush time
- 3**  Configures cistern refill time
- 4**  Toggles Wave function ON/OFF (Walkaway ONLY)
- 5**  12-hour hygiene cycle activation
- 6**  Dual flush activation
- 7**  Aurorange setting of sensor range
- 8**  Siphonic trap refill activation
- 9**  Resets to default factory settings

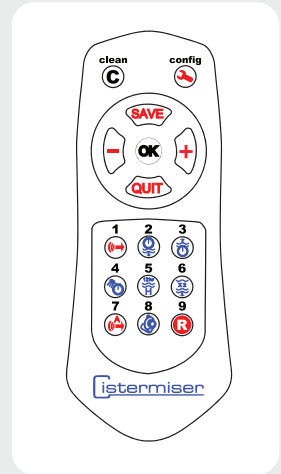

entering configuration mode

Point the ICU towards the **easyflush** sensor and push the configuration  button. Activation is most effective when the configuration button is held down as the ICU is brought close to the sensor.

It can take up to 3 seconds for the product to sense the ICU. The **easyflush** will return to normal operation if there are no button presses for 30 seconds.

configuring sensor range

Point the ICU at the **easyflush** sensor and press the **1**  sensor range button (the sensor blinks green).

Decrease or increase the sensor range by pressing the  and  buttons respectively.

The sensor blinks red when the min or max value is reached.

Press the  button to check the sensor range setting - the sensor displays the current setting by flashing green; see table.

For Wave version

Number of flashes	1	2	3	4	5
Range (cm approx)	6	9	11	15	17

For Walkaway version

Number of flashes	1	2	3	4	5
Range (cm approx)	45	50	53	56	58

Save setting and exit ICU configuration mode by pressing  the button.

Exit without saving by pressing the  button.

configuring part flush time

Point the ICU at the **easyflush** sensor and press the **2**  flush time button (the sensor blinks green).

Decrease or increase the part flush time by pressing the  and  buttons respectively. The sensor blinks red when the min or max value is reached.

Press the  button to check the part flush time setting - the sensor displays the current setting by flashing green; see table.

Number of flashes	1	2	3	4	5
Part flush time (sec)	1	2	3	4	5

Save setting and exit ICU configuration mode by pressing the  button.

Exit without saving by pressing the  button.

NOTE: The full flush volume is set by setting the float height in the cistern.

configuring refill time

Point the ICU at the **easyflush** sensor and press the **3**  refill time button (the sensor blinks green).

Decrease or increase the refill time by pressing the  and  buttons respectively. The sensor blinks red when the min or max value is reached.

Press the  button to check the refill time setting - the sensor displays the current setting by flashing green; see table.

Number of flashes	1	2	3	4	5	6	7
Refill time (sec)	0	20	40	60	80	100	120

Save setting and exit ICU configuration mode by pressing the  button.

Exit without saving by pressing the  button.

activating and de-activating the hand wave flushing (walkaway version only)

Point the ICU at the **easyflush** sensor and press the **4**  (the sensor blinks green). By default the hand wave function is on.

Pressing the  and  button switches the hand wave function on or off respectively.

Press the  button to check the setting - the sensor flashes green once if function is off or twice if it is on.

Save setting and exit ICU configuration mode by pressing the  button.

Exit without saving by pressing the  button.

activating the 12-hour hygiene flush cycle

Point the ICU at the **easyflush** sensor and press the hygiene cycle button (the sensor blinks green).

Pressing the  and  buttons switches the hygiene flush function on or off respectively.



Press the  button to check the setting - the sensor flashes green once if function is off or twice if it is on.

Save setting and exit ICU configuration mode by pressing the  button.

Exit without saving by pressing the  button.

activating the dual flush function

Point the ICU at the **easyflush** sensor and press the **6**  (the sensor blinks green).

Pressing the  and  buttons switches the dual flush function on or off respectively. Press the  button to check the setting - the sensor flashes green once if function is off or twice if it is on.

Save setting and exit ICU configuration mode by pressing the  button.

Exit without saving by pressing the  button.

configuring sensor range using the autorange function

If the cubicle door is opposite the sensor, ensure that the cubicle door is closed or ajar, but not fully open.

Point the ICU at the **easyflush** sensor and press the **7**  button.

Immediately stand clear of the sensor. Sensor blinks green for 5 seconds, then a steady green when setting complete. The sensor measures the background reflections and sets the sensor range to an appropriate setting.

Save setting and exit ICU configuration mode by pressing the  button.

Exit without saving by pressing the  button.

11 Frequently asked questions

indicators for normal sensor function after user activation

Wave:

- single **green** flash once a second (if part flush)
- double **green** flash once a second (if full flush)
- constant rapid **green** flash (if re-flush has been requested)

Walkaway:

- 3 seconds between **green** flashes (if a presence is detected)
- single **green** flash once a second (if part flush)
- double **green** flash once a second (if full flush)
- constant rapid **green** flash (if re-flush has been requested)

no water is entering the cistern

No obvious indicator	Ensure that the water supply is reaching the valve. Minimum working pressure 0.5 bar dynamic, maximum 6.0 bar static.
	Air in inlet hose (normally found with low pressure). Ensure loop is facing downwards.
	Blockage. Ensure the filters on the inlet and outlet side of the valve are clear.
The sensor is covered	Anti vandal mode has been triggered. The object/debris needs to be removed from the sensor and the valve will resume normal functionality.

the valve is not working at all

The sensor light does not flash when a hand is placed in front of it.	Ensure the power supply is connected. If mains power is being used through the mains adaptor check that the mains adaptor is working by reverting to the battery pack. Remove the mains adaptor when using batteries.
Sensor is flashing red slowly or not at all when hand is placed in front of it.	Low or no battery power; change batteries. If operated by mains power, check wiring then contact Cistermiser.
No obvious indicator	Ensure there is a good water supply and pressure of 0.5 to 6 bar.

continuous flow into the pan from the cistern

No obvious indicator	Check the seal of the flush valve and clean away any debris or scale.
No obvious indicator	Water flowing through the overflow; ensure that the water entering the cistern is being shut off by adjusting the float accordingly. If the float is set too high, water will continuously flow into the cistern and out of the overflow.
Sensor is flashing red slowly or not at all when hand is placed in front of it.	Low or no battery power; change batteries. If operated by mains power, check wiring then contact Cistermiser.

11 Frequently asked questions

WC flushes when in use

Working as normal otherwise	Ensure that the sensor is mounted in the correct position. Refer to installation schematic (section 3).
	Ensure the sensor range is correctly configured. Refer to the advanced setting guide (section 9).

other issues

Shuddering noise	Air in the system. Flush the valve repeatedly to purge the system.
Double red flash	Faulty wiring. Check wiring carefully.
	Faulty solenoid. Call Cistermiser for advice.
Red flash once every second	Low or no battery power. Change batteries. If operated by mains power, check wiring then contact Cistermiser.
Red flash twice every 3 seconds	Sensor covered or heavily scratched. Uncover or polish out scratches.

cistermiser product warranty and extended warranty

Cistermiser products are guaranteed for 12 months from the date of manufacture. The guarantee is for faulty products and parts only: there is no labour warranty. If you believe your product is faulty, please either contact Cistermiser directly on **0118 969 1611** or at **warranty@cistermiser.co.uk**, with a photograph and the serial number, to diagnose the cause of the problem.

The warranty on Cistermiser products can be extended, within one year of date of manufacture, at no cost to three years from the date of installation by completing the enclosed warranty card or at **www.cistermiser.co.uk/warranty**. Please make a note of the serial number and take a photograph of the installation before you leave site.

