

INNOVATION | MANUFACTURER | DESIGN | SOLUTION

JANUARY 2022

AMPHIBIA INSTALLATION GUIDE





CONTENT

We offer a broad range of high performance structural waterproofing products – from waterproofing membranes to ground gas protection systems.



SECTION 1

Introduction 1

SECTION 2

Preparations 7

SECTION 3

Applications 9

SECTION 4

Service Penetrations 26



Section 01

Introduction

- 1.1 OVERVIEW
- 1.2 RADON & METHANE
- 1.3 DELTA AMPHIBIA 1.3MM
- 1.4 DELTA AMPHIBIA 1.6MM

Introduction

1.1 OVERVIEW

Delta Amphibia is a Pre- & Post- Applied Fully Bonded Waterproofing Membrane with Reactive Core.

Delta Amphibia is a hydro-reactive, self-healing, self-sealing multi-layer waterproofing system which can be applied on vertical and horizontal areas of new construction.

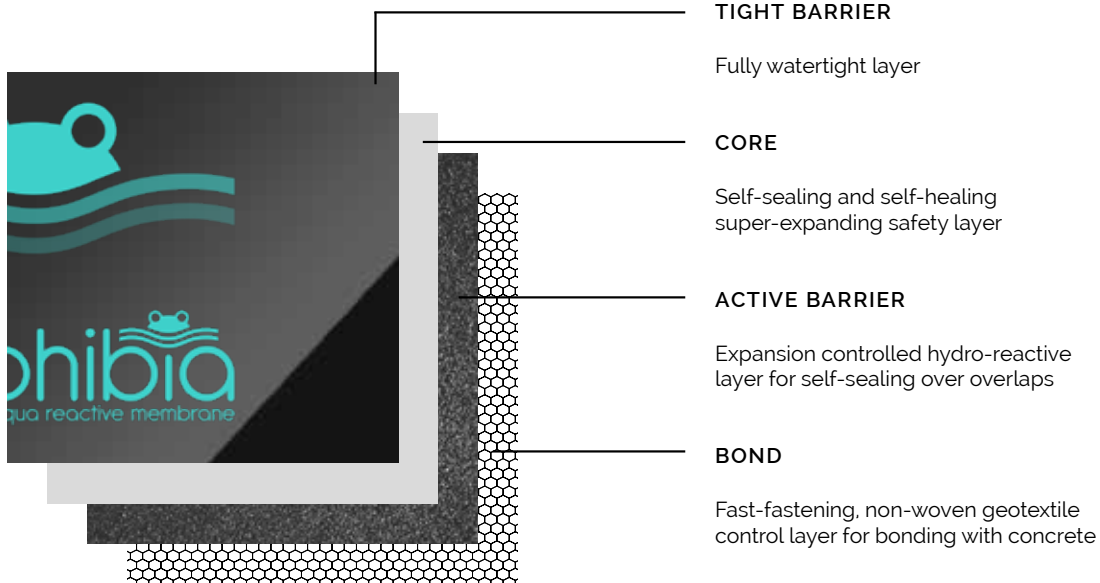

BEST PRACTICE

Best practice defines a process, method(s), or technique(s) which when executed, effectively leads to enhanced project performance.

Best practice is based on the adoption of regulations, standards, specifications, coordinating methods and procedures that are to be used, benchmarking, compatibility and quality of products and compliance of a particular product, service, or material.

Best practices maintain quality.

"At our very core, we are driven by a diverse team that is dedicated to innovation and is passionate about creating integrated, maintainable and robust solutions".

REGISTERED INSTALLER NETWORK

As manufacturers of quality systems, it is imperative to work with quality installation companies. At Delta, we pride ourselves that we've built a team of highly qualified, reliable, specialist approved Registered Installers.

Delta Registered Installers Network are an elite group of experienced Delta System installers who share our values – a dedication to quality, authenticity and exceptional customer services.

Our Delta Registered Installer Partners all have extensive experience of working with and installing Delta Systems, meaning you can be confident of a quick, efficient installation, carried out with the minimum of disruption and fuss.

All Delta Registered Installers adhere to a strict-criteria and are required to attend training as well as demonstrating quality of workmanship before accreditation of the Registered Installer title, resulting in a meaningful scheme that provides unrivalled technical excellence.

PRODUCT GUARANTEES

Delta Membrane Systems Limited offer a 10-year Product Guarantee on all Amphibia membranes, seals and fixings when the Delta Amphibia system has been installed by a Delta Registered Installer.



Introduction

Triple active protection for watertight waterproofing

- Self Repairing
- Self Sealing
- Self Fastening

ADVANTAGES

- BBA Certified
- Type A Waterproofing Solution to BS 8102:2022
- Cold application with capabilities of testing tightness through simple inspections
- Self-Sealing overlapping
- Fully Bonded
- Impermeability with no side seepage of water
- Immediate mechanical protection
- Self repairing on accidental holes
- High resistance of hydraulic load
- Highly flexible, easily adapts to different configurations of supports
- Crack bridging capability
- Easy passage of connecting reinforcements with self-sealing holes
- Resistance to aggressive natural agents contained in the ground
- Usable where there is a presence of salt water
- Water tight even where water is not considered present
- Easy and quick installation

TYPICAL FIELDS OF APPLICATION

- Residential Buildings
- Commercial Buildings
- Industrial (Retail Units and Warehouses)
- Leisure Facilities
- Archives/Libraries/Vaults
- Hospitals
- Schools
- Underground Rail Stations and Tunnelling
- Underground Car Parking Areas
- Engineered Structures
- Tunnel shafts
- Insulated Formwork Construction (ICF)

AREAS OF USE

- New build basements
- Foundations
- Tunnels
- Garages
- All other concrete constructions below ground

The benefits of Delta Amphibia waterproofing:

- High durability
- No lateral water underflow
- High flexibility and crack bridging ability
- Cost effective solution

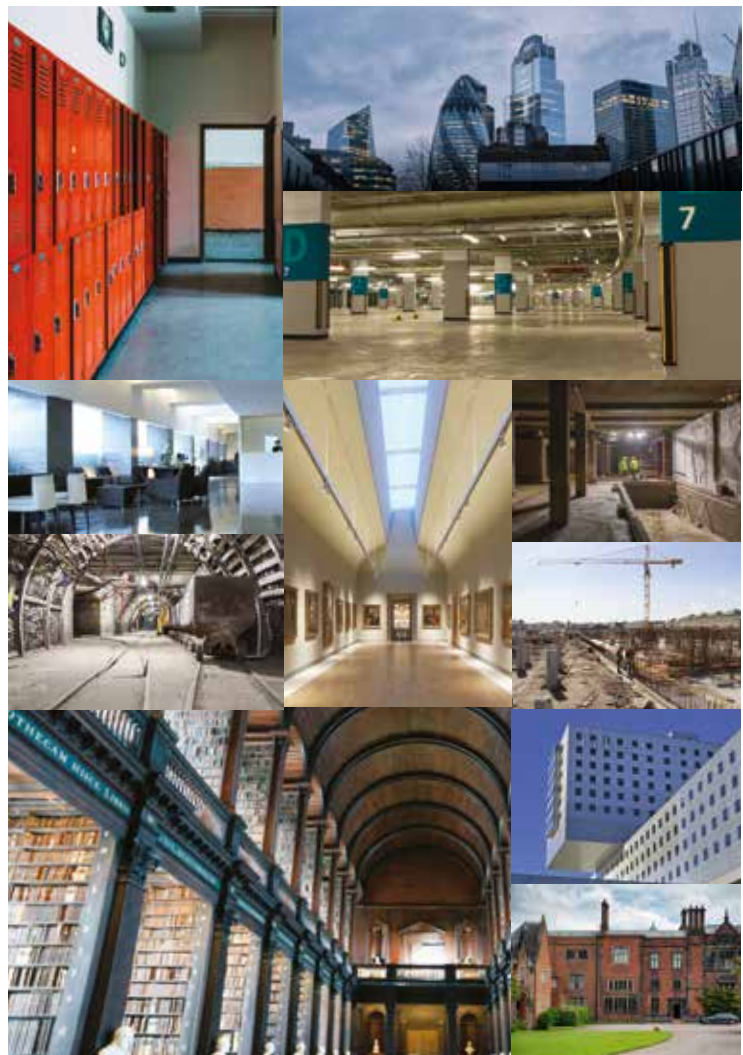

Introduction

1.2 RADON AND METHANE

GAS RADON

The presence of gas (methane and radon) in the soil can be a relevant problem for underground structures. In particular, Radon is a radioactive gas naturally occurring in the ground. There is a higher concentration of radon if the house is above or near granitic or volcanic land, especially if its foundations are resting directly on the ground. What can be done about it? Once ascertained that the radon level in the house is higher

than average – radon is also present in upper floors, but it decreases with height – you need to reduce its hazard. Soil depressurisation, forced ventilation in crawl spaces, foundation waterproofing, crack sealing as well as ventilation of rooms can be carried out to face the issue.

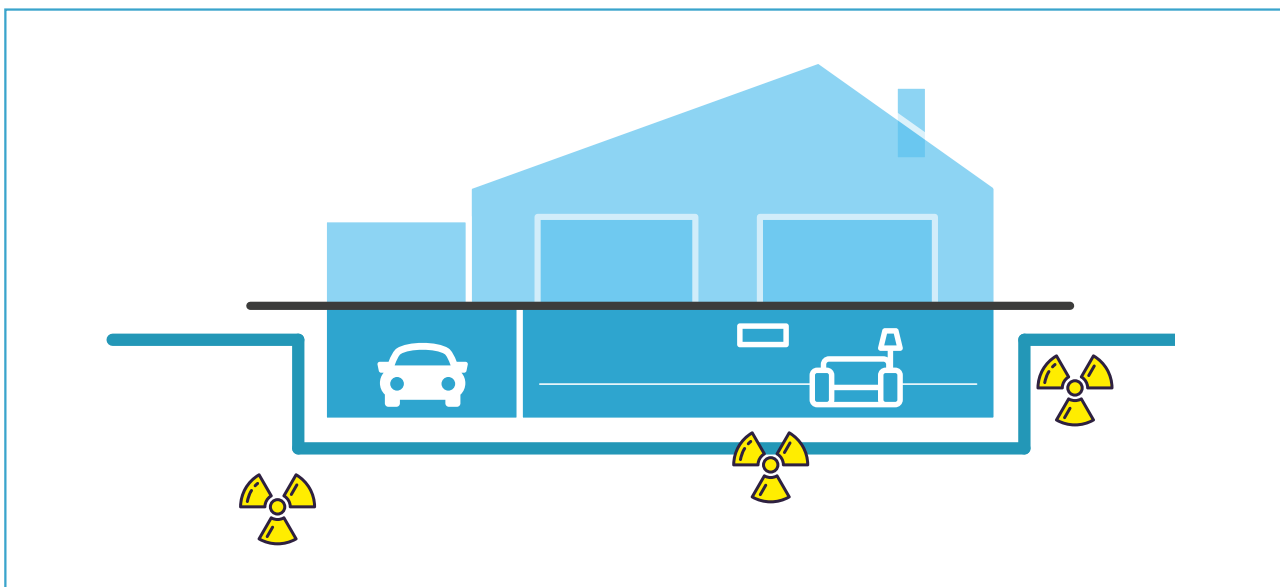

RADON & UNDERGROUND STRUCTURES:

Radon is an inert gas, which means that it does not chemically react with the environment around it. Once generated, it can migrate through the soil and spread from construction materials. The concentration of radon in a house depends on many factors: the presence of uranium and radium in the soil and in construction materials, soil permeability, construction techniques and living habits. The pressure inside buildings is generally lower than outside. The lower pressure influences the normal convective motion of the soil, so that radon is 'drawn' inside the buildings themselves, penetrating through different areas: cracks in the foundation bed or vertical walls, construction joints in the horizontal and vertical connection points, bed interruptions or drains.

In this sense, both in new buildings and in underground structures to be refurbished, at the design stage it is best to provide for vents, construction joints, cracks and drains.

In this way the Delta Amphibia system can be considered a protection against gas ingress in the structures reducing risks for health.

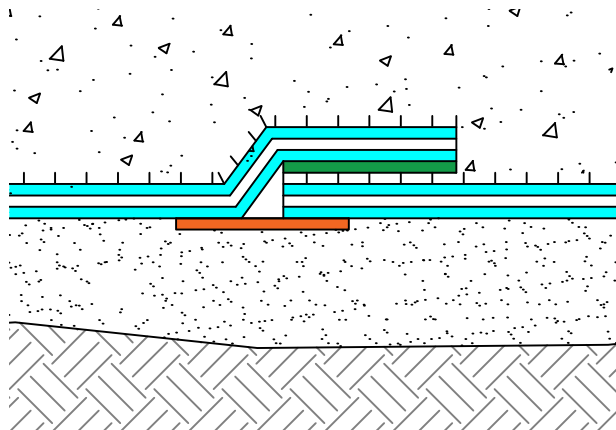

Introduction

1.3 DELTA AMPHIBIA 1.3MM

Delta Amphibia 1.3mm Pre-Applied membrane is a co-extruded multi-layer waterproofing membrane. This robust, tough but flexible waterproofing membrane is ideal for all construction applications. Delta Amphibia is an EPDM waterproof membrane available in two widths, reactive to contact with water, self-repairing, self-sealing and self-fastening to concrete.

Delta Amphibia offers differentiated function for total water tightness of underground structures against water seepage. Moreover, it is provided with a calibrated non-woven fabric on the inner face/side in contact with fresh concrete which allows the mechanical adhesion of the membrane to the structure.

- Cold application with easy visual inspection of correct installation
- Resistant to groundwater
- Self-sealing overlapping's
- Absolute impermeability, with no side seepage of water
- High puncture resistance
- Immediate mechanical protection, self-repairing also on accidental holes
- High resistance to hydraulic load
- High flexibility and capacity to bridge cracks
- Total adhesion to the reinforced concrete structure
- Easy passage of connecting reinforcements with self-sealing holes
- Resistance to aggressive natural agents contained in the ground
- Also usable in the presence of salt / Brackish water

FIELDS OF APPLICATION

Waterproofing and protection of concrete underground structures such as residential and commercial buildings, shopping centres, public works etc, which require close and continuous contact between the waterproofing product and structure (foundation slabs and walls, against slurry walls, piles, Berlinese or disposable formwork. It can also be used in other structures such as channels, tanks, purification systems and tunnels.

Anti-damp protection for concrete structures built at ground level such as underfloor screeds.

Delta Amphibia Pre-Applied Membrane 1.3mm can be used:

- Multi-storey underground constructions
- Cellars, garages, tavern, technical rooms, underground rooms in general
- Tunnels, underpasses, and similar infrastructures
- Inground pool waterproofing
- Existing cellars, garages, tavern, technical rooms, underground rooms in general
- Existing tunnels, underpasses, and similar infrastructures
- Elevator pits/lightwells

TECHNICAL DATA

Specification	Delta Amphibia 1.3mm	Delta Amphibia 1.3mm
Product Code	DMS 1036	DMS 1035
Roll Dimensions	1.80m x 20m (70.87 X 787.40in)	0.9m x 10m (35.43 X 393.70in)
Membrane Thickness	1.3mm	1.3mm
Equivalent Area	36 ² m (387.5 ft ²)	9 m ² (96.9 ft ²)
Roll Weight	59kg (130lbs)	15kg (33lbs)
Tolerance	+/- 5%	+/- 5%



Introduction

1.4 DELTA AMPHIBIA 1.6MM

Delta Amphibia 1.6mm Pre-Applied membrane is a co-extruded multi-layer waterproofing membrane. This robust, tough but flexible waterproofing membrane is ideal for all construction applications. Delta Amphibia is an EPDM waterproof membrane available in two widths, reactive to contact with water, self-repairing, self-sealing and self-fastening to concrete.

Delta Amphibia offers differentiated function for total water tightness of underground structures against water seepage. Moreover, it is provided with a calibrated non-woven fabric on the inner face/side in contact with fresh concrete which allows the mechanical adhesion of the membrane to the structure.

- Cold application with easy visual inspection of correct installation
- Resistant to groundwater
- Self-sealing overlapping's
- Absolute impermeability, with no side seepage of water
- High puncture resistance
- Immediate mechanical protection, self-repairing also on accidental holes
- High resistance to hydraulic load
- High flexibility and capacity to bridge cracks
- Total adhesion to the reinforced concrete structure
- Easy passage of connecting reinforcements with self-sealing holes
- Resistance to aggressive natural agents contained in the ground
- Also usable in the presence of salt / Brackish water

FIELDS OF APPLICATION

Waterproofing and protection of concrete underground structures such as residential and commercial buildings, shopping centres, public works etc, which require close and continuous contact between the waterproofing product and structure (foundation slabs and walls, against slurry walls, piles, Berlinese or disposable formwork. It can also be used in other structures such as channels, tanks, purification systems and tunnels.

Anti-damp protection for concrete structures built at ground level such as underfloor screeds.

Delta Amphibia Pre-Applied Membrane 1.6mm can be used:

- Multi-storey underground constructions
- Cellars, garages, tavern, technical rooms, underground rooms in general
- Tunnels, underpasses, and similar infrastructures
- Inground pool waterproofing
- Existing cellars, garages, tavern, technical rooms, underground rooms in general
- Existing tunnels, underpasses, and similar infrastructures
- Elevator pits/lightwells

TECHNICAL DATA

Specification	Delta Amphibia 1.6mm	Delta Amphibia 1.6mm
Product Code	DMS 1001	DMS 1000
Roll Dimensions	1.80m x 20m (70.87 X 787.40in)	0.9m x 10m (35.43 X 393.70in)
Membrane Thickness	1.6mm	1.6mm
Equivalent Area	36 ² m (387.5 ft ²)	9 m ² (96.9 ft ²)
Roll Weight	59kg (130lbs)	15kg (33lbs)
Tolerance	+/- 5%	+/- 5%





Section 02 Preparation

2.1 PREPARATION

Preparation

2.1 PREPARATION

Delta Amphibia Membranes and System Components should be installed in accordance with the recommendations of the relevant codes of practice and industry guidance, such as BS 8102:2022 Protection of below ground structures against water ingress. Code of practice and CP 102:1973 Code of practice for protection of buildings against water from the ground.

Type-A protection is defined by BS 8102:2022 Protection of below ground structures against water ingress. Code of practice as 'barrier protection'. This is where Delta Amphibia is installed which offers a barrier to the passage of water with the aim of keeping the target environment within a prescribed level of 'dryness'.

The Delta Amphibia Waterproofing System should only be installed to a suitably prepared substrate.

Bonded systems, such as the Delta Amphibia System can be distinguished according to their time of installation into pre- and post-applied. Pre-applied bonded systems are installed before the concrete works on a mud-slab, a soil retention system, or a formwork and later form a bond with the subsequently poured fresh concrete. They can be installed in horizontal formation, with the concrete structure being built directly on top. These systems require special care on site since no additional protection layers are applied. Further concrete works on pre-applied membranes can lead to soiling and punctual damage, eventually affecting the bond or the waterproofing system.

Post applied systems are installed onto existing hardened concrete structures.

Correct substrate preparation of concrete surfaces is essential in creating a full and durable bond to prevent any water migration or lateral water underflow between the concrete structure and the Delta Amphibia System.

Quality of concrete is a key factor for successful Type A waterproofing.

For successful waterproofing using Delta Amphibia detailed planning should be considered at the earliest possible stage of the design process.

All service penetrations should be fully sealed and included in the detailed planning.

A risk assessment should be carried out to identify any possible long-term water pressures, the effects of surface water percolation, use of external drainage and the effects of party wall impaction on neighbouring structures.

The water tightness of a Type A System relies fundamentally on the effectiveness of the waterproofing system, site and design preparation, installation of the membrane system and the structure.

Delta Amphibia Membranes can be positioned in a variety of different situations as part of a combined system, for example:

- Externally to new formed concrete
- Between contiguous or secant piles and a concrete liner wall
- Externally in combination with a Type B Waterproof concrete system
- Beneath basement and ground bearing slabs
- In combination with an internal Type C Delta Cavity Drainage Membrane System
- As an effective external system for lift pits and service trenches

An aerial, black and white photograph of a construction site. The image shows a large rectangular area with a grid of rebar (steel reinforcement) laid out on a concrete slab. Scaffolding and wooden formwork are visible around the perimeter and within the area. The ground is uneven and appears to be a construction site. A semi-transparent blue rectangle is overlaid on the left side of the image, containing the text 'Section 03 Application' and a horizontal line.

Section 03 Application

Application

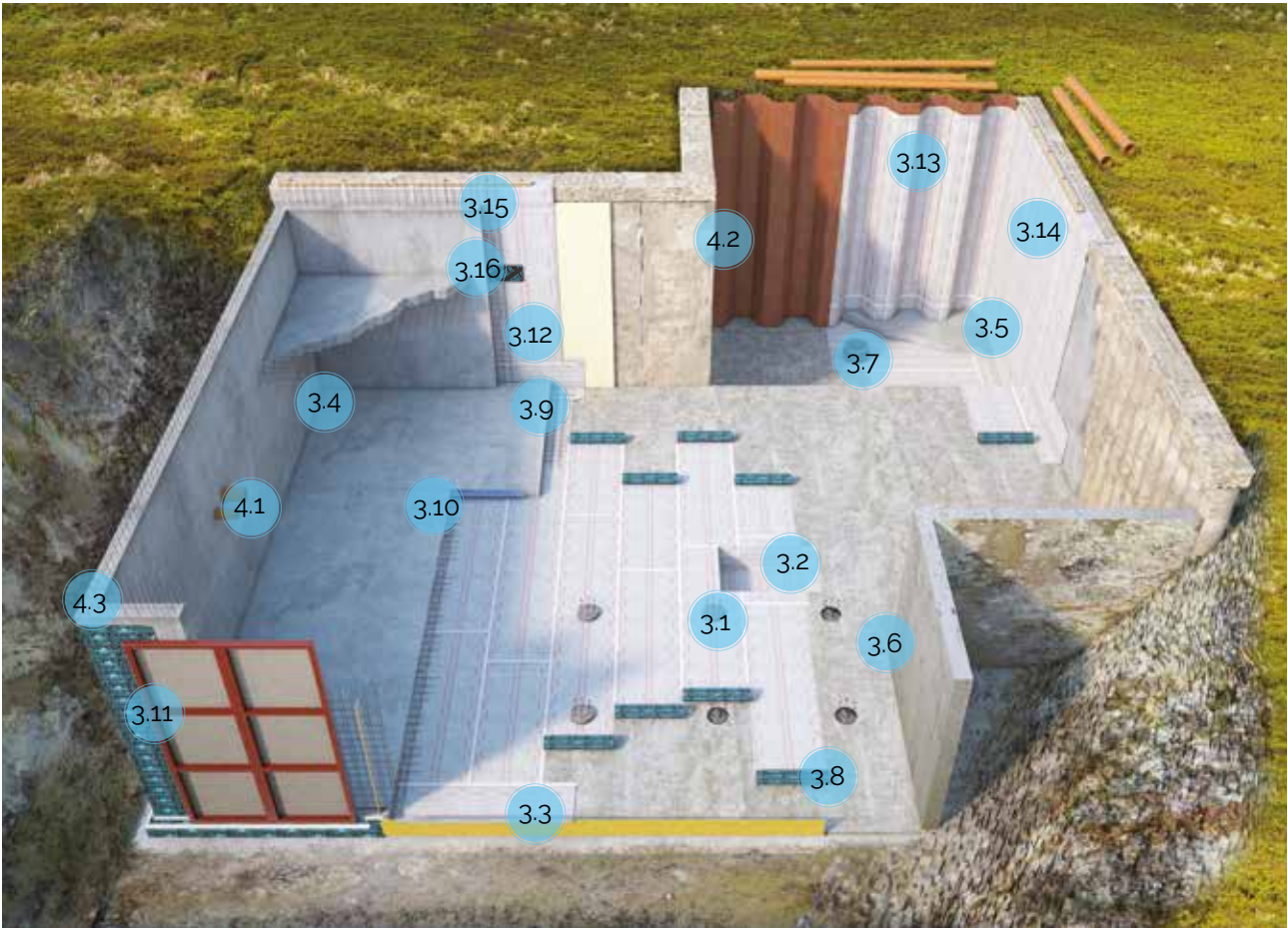

APPLICATION

- | | |
|--|---|
| 3.1 Foundation Piles | 3.9 Joints in Raft Foundation |
| 3.2 Lift Pit | 3.10 Joints in Raft Foundation |
| 3.3 Application on Raft Foundation Toe | 3.11 Vertical Application on Formworks |
| 3.4 Corner 90° | 3.12 Vertical Application on Diaphragm Walls |
| 3.5 Corner 90° | 3.13 Vertical Application on Metal Sheet Piling |
| 3.6 Corner 90° | 3.14 Vertical Application on Pile Walls |
| 3.7 Presence of dewatering wells and different heights | 3.15 Joints in Retaining Walls |
| 3.8 Sheet Application | 3.16 Slab Sealing in Blindside Installation |

SERVICE OF PENETRATIONS

- 4.1 Sealing of Penetration
- 4.2 Sealing of Penetration
- 4.3 Connections and Sealing Details

Application

3.1 FOUNDATION PILES

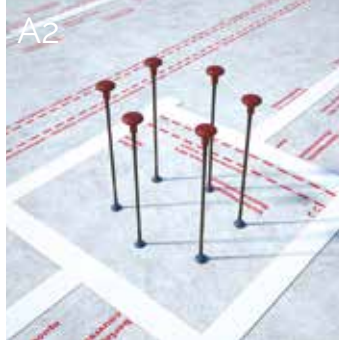
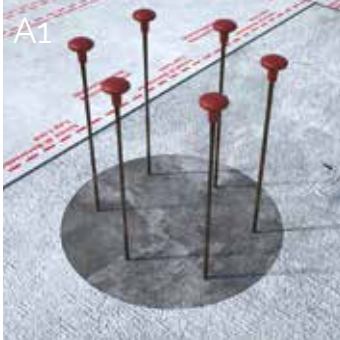

A1/A2 | DELTA AMPHIBIA OVER PILE HEADS

1. Soil
2. Foundation pile
3. Lean concrete
4. Reconstruction with Koster Repair Mortar Plus
5. Delta Amphibia over pile heads
6. Concrete protective screed (optional)
7. Steel bars sealed with Delta Amphibia AKTI-VO 201
8. RC structure suitable to withstand hydraulic pressures and exempt from defects

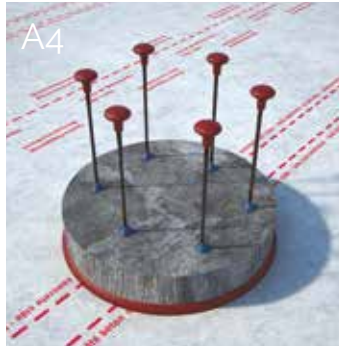
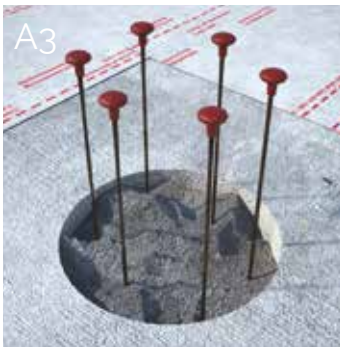
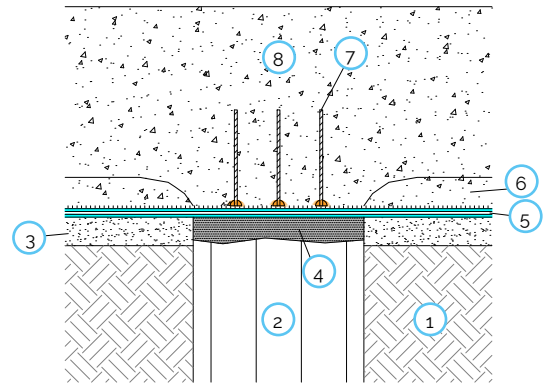

A3/A4

1. Soil
2. Foundation pile
3. Lean concrete
4. Suitable reconstruction with Koster Repair Mortar Plus or with concrete externally waterproofed with Koster NB1
5. Delta Amphibia
6. Delta Amphibia AKTI-VO 201
7. Koster Quellband
8. Concrete protective screed (optional)
9. Steel bars sealed with Delta Amphibia AKTI-VO 201 or Koster Quellband
10. RC structure suitable to withstand hydraulic pressures and exempt from defects

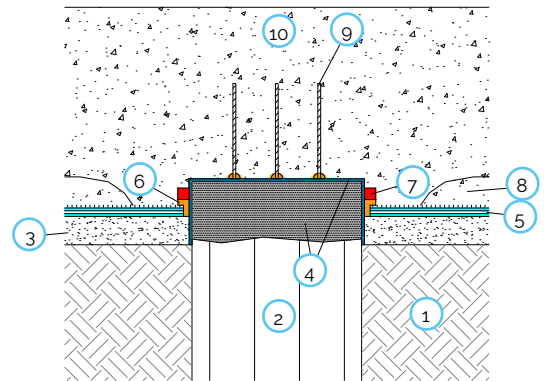

Application

3.2 LIFT PIT

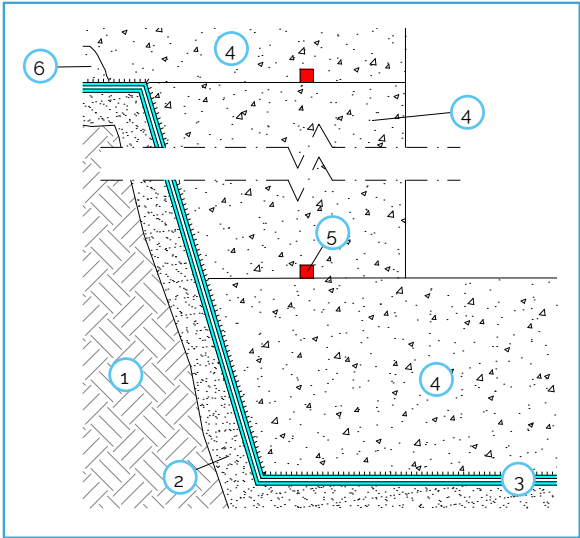
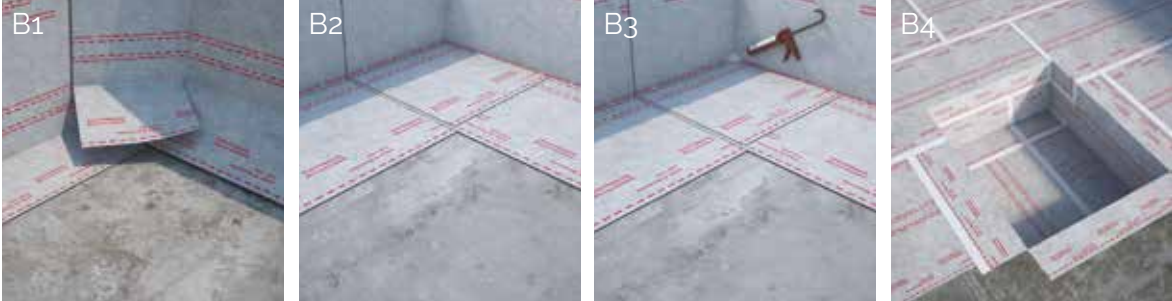

B1/B2/B3/B4 | LIFT PIT

- 1. Soil
- 2. Lean concrete
- 3. Delta Amphibia
- 4. RC structure suitable to withstand hydraulic pressures and exempt from defects
- 5. Koster Quellband
- 6. Concrete protective screed (optional)



LIFT PIT WITH DELTA AMPHIBIA SYSTEM

Application

3.3 APPLICATION ON RAFT FOUNDATION TOE

OPEN BASEMENT EXCAVATION

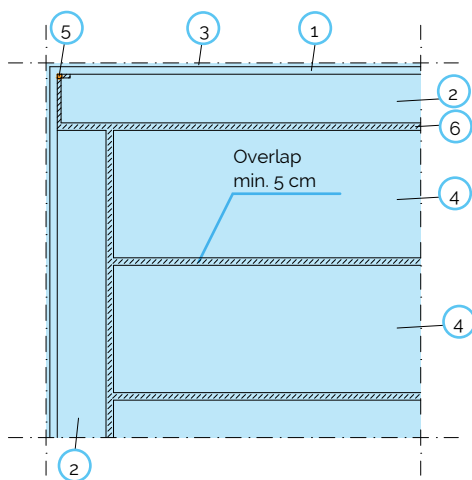

RAFT FOUNDATION: DELTA AMPHIBIA INSTALLATION ON LEAN CONCRETE BLINDING

1. Formworks
2. Delta Amphibia H.90 vertically installed all along the formworks and folded on the raft foundation.
3. Delta Amphibia H.90 flap over the formwork
4. Delta Amphibia H.180 on lean concrete
5. Delta Amphibia AKTI-VO 201
6. Delta Amphibia Safety Tape or Delta Amphibia BI-Mastic



RAFT FOUNDATION WITH DELTA AMPHIBIA SYSTEM

Application

3.4 CORNER 90°

OPEN BASEMENT EXCAVATION

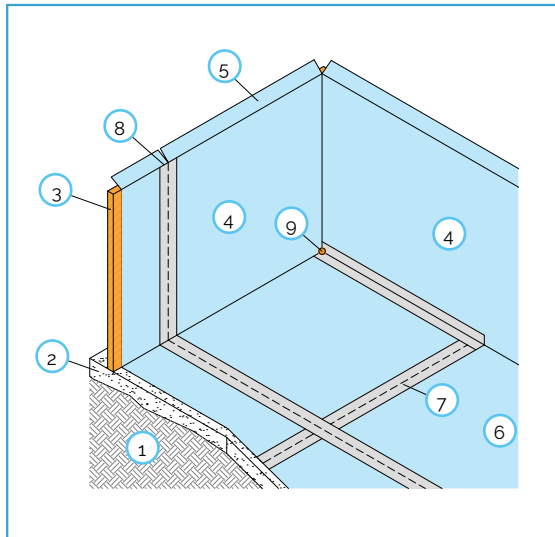

D1.1 SEALING OF INTERNAL 90° CORNER ON

D1.2 FORMWORKS

D1.3

D1.4

1. Soil
2. Lean concrete
3. Formwork
4. Delta Amphibia H.90 vertically applied all along the formworks and folded on the raft foundation
5. Delta Amphibia H.90 flap over the formwork
6. Delta Amphibia H.180 on lean concrete
7. Delta Amphibia Safety Tape or Delta Amphibia BI-Mastic
8. Apply staples to fix vertically the sheets to the formworks
9. Delta Amphibia AKTI-VO 201



90° CORNER IN CASE OF OPEN BASEMENT EXCAVATION WITH DELTA AMPHIBIA SYSTEM

Application

BLINDSIDE

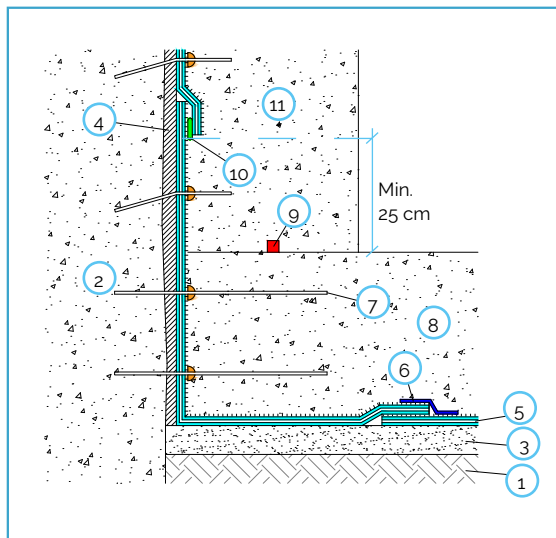
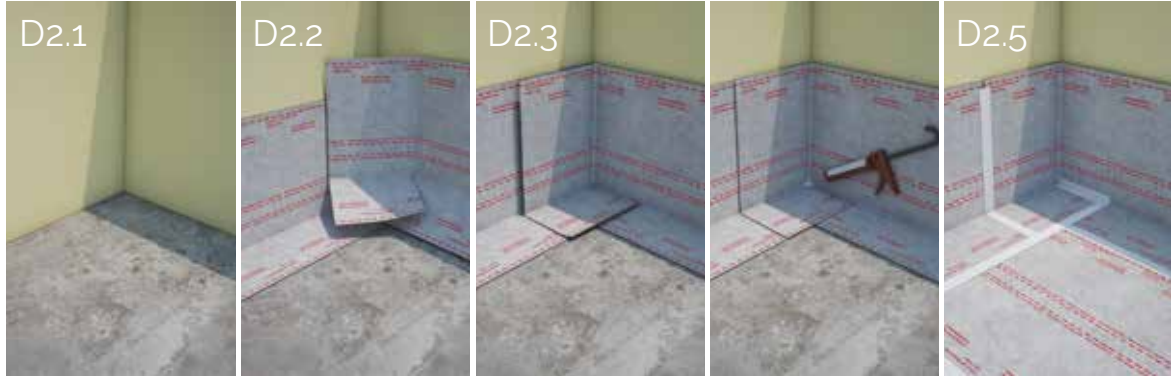

D1.1 SEALING OF INTERNAL 90° CORNER ON D1.2 DIAPHRAGM WALLS

D1.3 D1.4

1. Soil
2. Diaphragm walls
3. Lean concrete
4. Smoothing or non-degradable rigid panel
5. Delta Amphibia
6. Delta Amphibia Safety Tape or Delta Amphibia BI-Mastic
7. Connectors sealed with Delta Amphibia AKTI-VO 201
8. RC raft foundation suitable to withstand hydraulic pressures and exempt from defects
9. Koster Quellband
10. Delta Amphibia BI-Mastic
11. RC walls suitable to withstand hydraulic pressures and exempt from defects



90° CORNER IN CASE OF BLINDSIDE APPLICATION WITH DELTA AMPHIBIA SYSTEM

Application

3.6 CORNER 90°

OPEN BASEMENT EXCAVATION

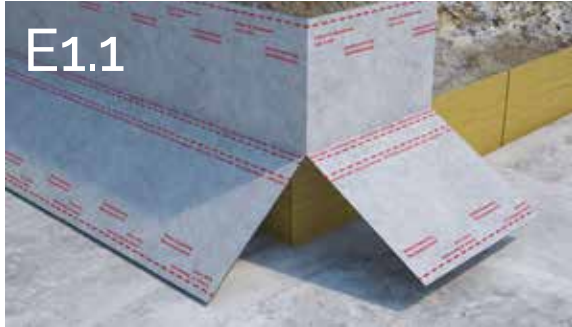

E1.1 SEALING OF INTERNAL 270° CORNER ON
E1.2 FORMWORKS

E1.3

E1.4

1. Formwork
2. Delta Amphibia H.90 vertically applied all along the formworks and folded on the raft foundation
3. Delta Amphibia H.90 flap over the formwork
4. Delta Amphibia H.180 on lean concrete
5. Delta Amphibia Safety Tape or Delta Amphibia BI-Mastic
6. Delta Amphibia AKTI-VO 201

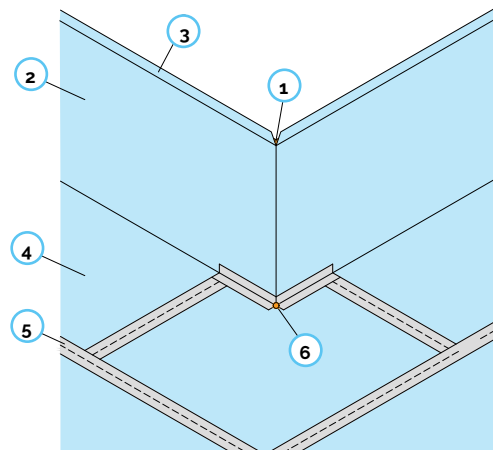

270° CORNER IN CASE OF OPEN BASEMENT EXCAVATION WITH DELTA AMPHIBIA SYSTEM

Application

3.8 PRESENCE OF DEWATERING WELLS AND DIFFERENT HEIGHTS

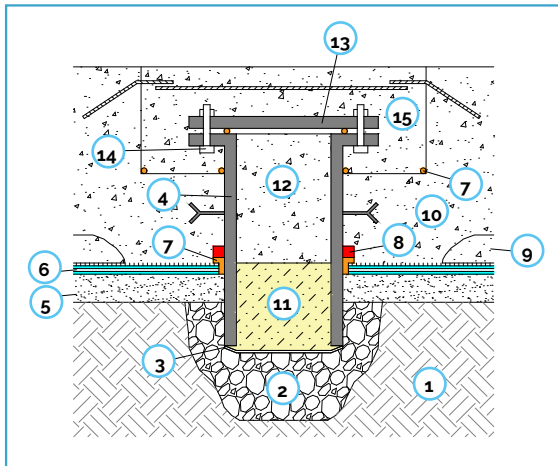
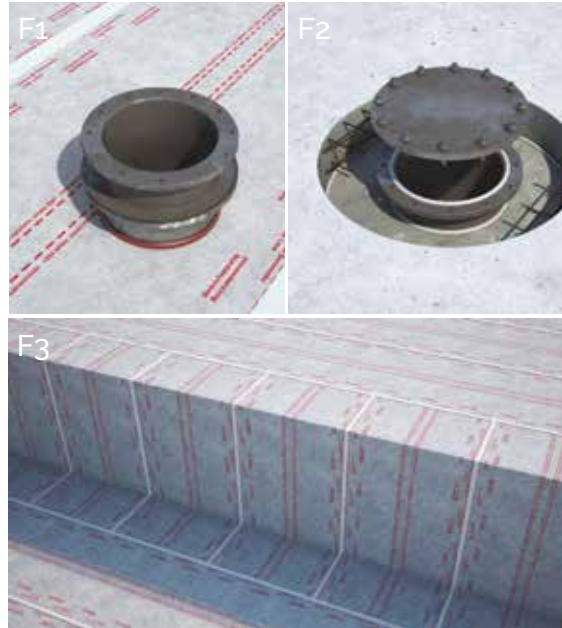

F1/F2 DEWATERING WELL WITH DELTA AMPHIBIA

1. Soil
2. Drainage area
3. Non-woven textile + net
4. Flanged pipe with clamp-irons (stainless or galvanised)
5. Lean concrete
6. Delta Amphibia
7. Delta Amphibia AKTI-VO 201
8. Koster Quellband
9. Protective screed (optional)
10. RC raft foundation suitable to withstand hydraulic pressures and exempt from defects
11. Granular bentonite
12. Cast-in-place concrete to fill the well
13. Stainless steel cap sealed with Delta Amphibia AKTI-VO 201
14. Welded bolts
15. Cast-in-place concrete to fill the void on the raft

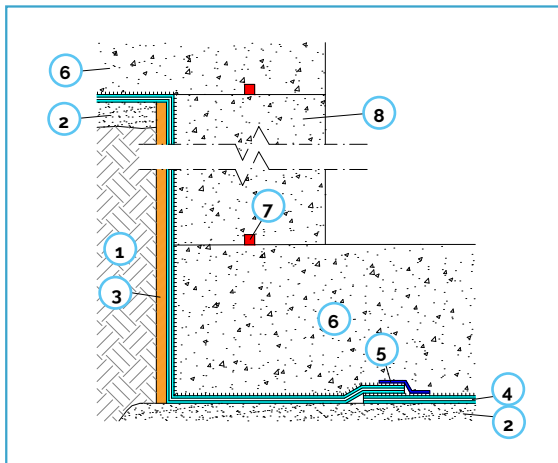

F3 RAFT FOUNDATIONS AT DIFFERENT HEIGHTS

1. Soil
2. Lean concrete
3. Disposable formwork or lean concrete
4. Delta Amphibia
5. Delta Amphibia safety tape or Delta Amphibia BI-Mastic
6. RC raft foundation suitable to withstand hydraulic pressures and exempt from defects
7. Koster Quellband
8. RC wall suitable to withstand hydraulic pressures and exempt from defects

Application

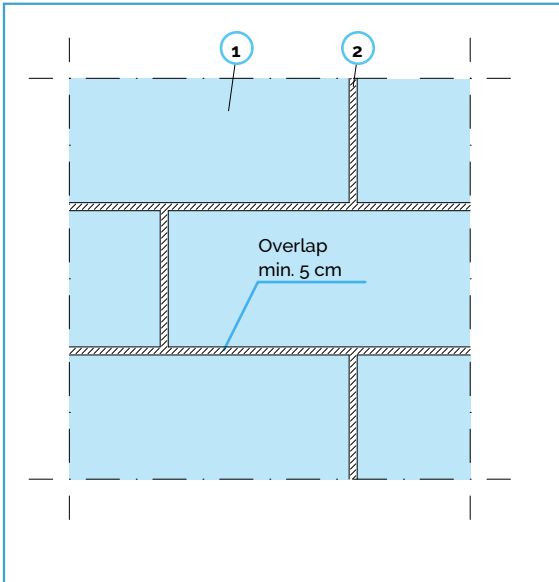

G1/G2 DELTA AMPHIBIA INSTALLATION PATTERN TYPE

- 1. Delta Amphibia
- 2. Delta Amphibia Safety Tape or Delta Amphibia BI-Mastic



RAFT FOUNDATION WITH DELTA AMPHIBIA SYSTEM

Application

3.10 JOINTS IN RAFT FOUNDATION

CONSTRUCTION JOINTS

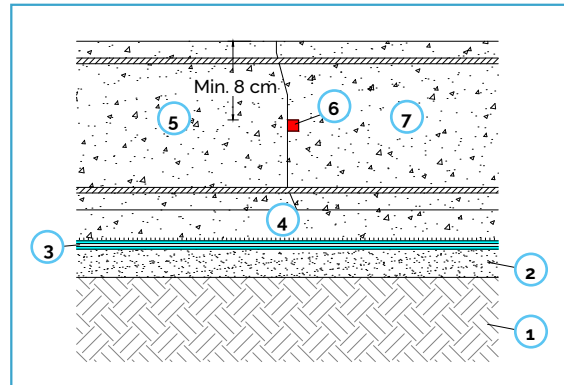
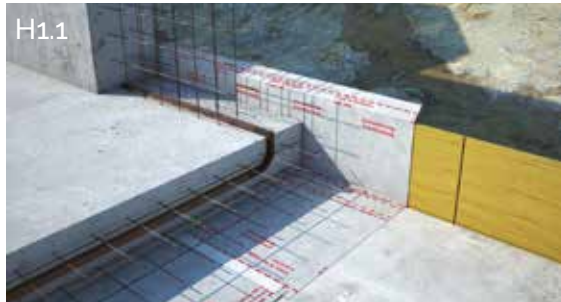

H1.1/H1.2
HORIZONTAL CONSTRUCTION JOINT (COLD JOINT) - RAFT FOUNDATION WITH DELTA AMPHIBIA

1. Soil
2. Lean concrete
3. Delta Amphibia
4. Concrete protective screed (optional)
5. First part of the RC raft foundation suitable to withstand hydraulic pressures and exempt from defects
6. Koster Quellband
7. Second part of the RC raft foundation suitable to withstand hydraulic pressures and exempt from defects



DETAIL OF BENTONITE SWELLABLE KOSTER WATERSTOP KOSTER QUELLBAND

Application

3.11 JOINTS IN RAFT FOUNDATION

EXPANSION JOINTS

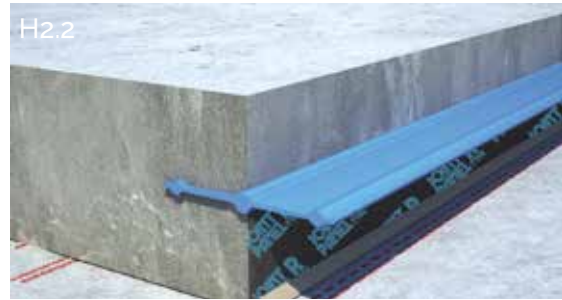
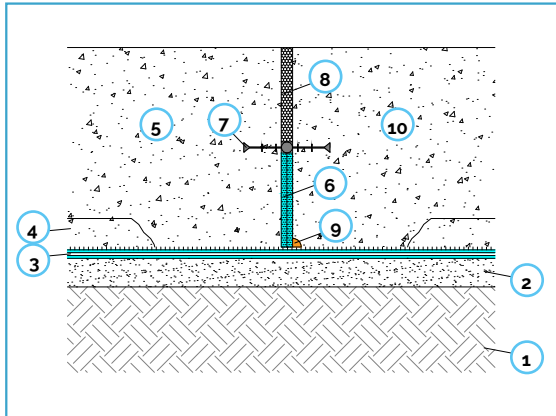

H2.2 RC RAFT FOUNDATION WITH DELTA AMPHIBIA - EXPANSION JOINT WITH PVC WATERSTOP

1. Soil
2. Lean concrete
3. Delta Amphibia
4. Concrete protective screed (optional)
5. First part of the RC raft foundation suitable to withstand hydraulic pressures and exempt from defects.
6. Joint Panel Type T (multiples)
7. PVC waterstop
8. Separating element
9. Delta Amphibia AKTI-VO 201
10. Second part of the RC raft foundation suitable to withstand hydraulic pressures and exempt from defects

Application

3.12 VERTICAL APPLICATION ON FORMWORKS

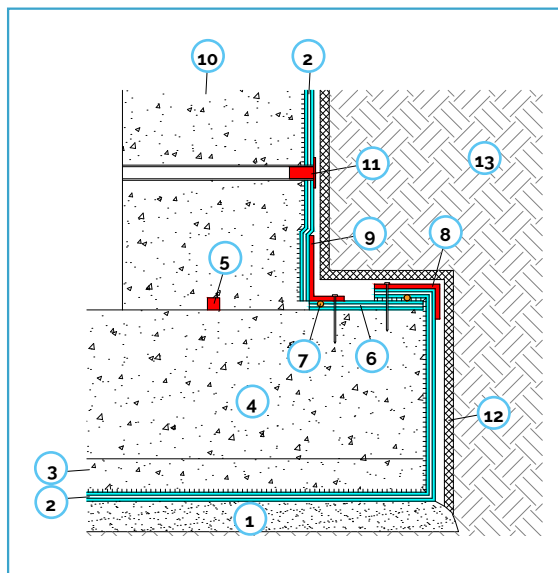

l1/l2/l3

CONSTRUCTION JOINT WITH DELTA AMPHIBIA PRE-APPLIED ON FORMWORKS WITH TOE

1. Lean concrete
2. Delta Amphibia
3. Concrete protective screed (optional)
4. RC raft foundation suitable to withstand hydraulic pressures and exempt from defects
5. Koster Quellband
6. Delta Delta Amphibia
7. Delta Amphibia BI-Mastic or Delta Amphibia AKTI-VO 201
8. Delta Amphibia Pressure Corner 90°
9. Delta Amphibia Pressure Corner 270°
10. RC wall suitable to withstand hydraulic pressures and exempt from defects
11. Delta Amphibia Stopper with Delta Amphibia AKTI-VO 201 to seal the distance tube
12. Rigid insulation panels or non-woven textile min 250 g/m²
13. Well compacted soil without voids

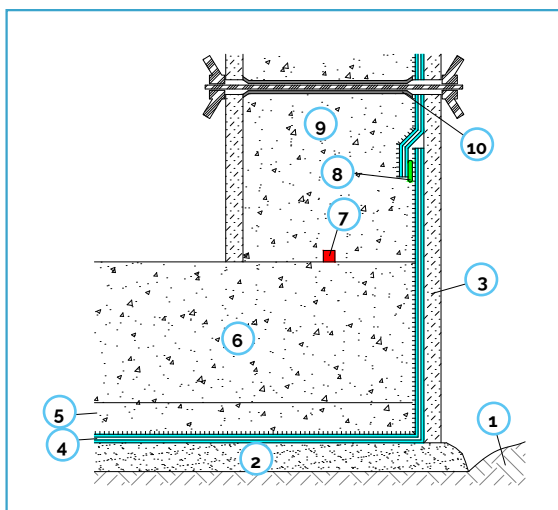

CONSTRUCTION JOINT WITH DELTA AMPHIBIA PRE-APPLIED ON FORMWORKS WITHOUT TOE

1. Soil
2. Lean concrete
3. Formwork
4. Delta Amphibia
5. Concrete protective screed (optional)
6. RC raft foundation suitable to withstand hydraulic pressures and exempt from defects
7. Koster Quellband
8. Overlaps fixed by stapling and/or with Delta Amphibia BI-Mastic
9. RC wall suitable to withstand hydraulic pressures and exempt from defects
10. Distance tube to seal consequently with Delta Amphibia Stopper and Delta Amphibia AKTI-VO 201

Application

3.13 VERTICAL APPLICATION ON DIAPHRAGM WALLS

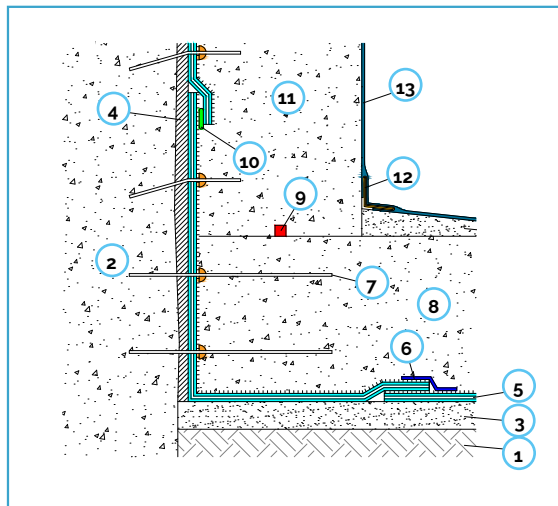

J1/J2/J3/J4 "LIGHT SHAFT" SHAFT WITH DELTA AMPHIBIA AND PLASTIVO

1. Soil
2. Diaphragm wall
3. Lean concrete
4. Suitable smoothing or non-degradable rigid panel
5. Delta Amphibia
6. Delta Amphibia Safety Tape or Delta Amphibia BI-Mastic
7. Connectors sealed with Delta Amphibia AKTI-VO 201
8. RC raft foundation suitable to withstand hydraulic pressures and exempt from defects
9. Koster Quellband
10. Delta Amphibia BI-Mastic
11. RC wall suitable to withstand hydraulic pressures and exempt from defects
12. Koster Repair Mortar Plus
13. Koster Koster NB1



APPLICATION OF DELTA AMPHIBIA SYSTEM ON REGULARIZED DIAPHRAGM WALLS

Application

3.14 VERTICAL APPLICATION ON METAL SHEET PILING

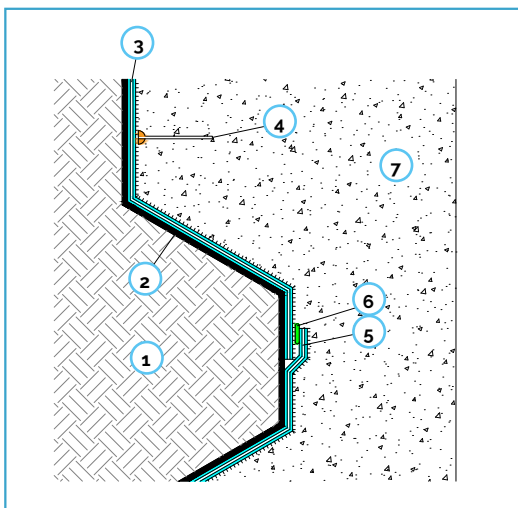
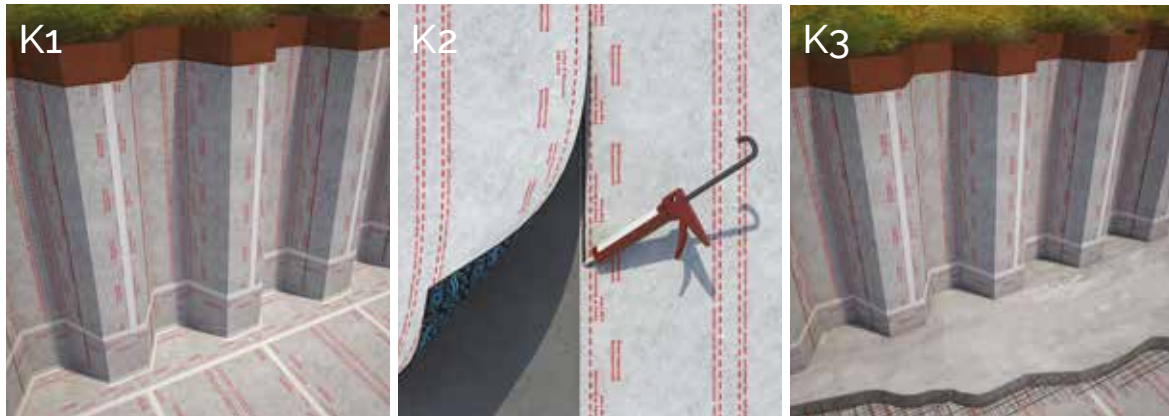

K1 DISPOSABLE METAL SHEET PILES WITH
K2 DELTA AMPHIBIA
K3

1. Soil
2. Metal sheet piles
3. Delta Amphibia
4. Connectors sealed with Delta Amphibia AKTI-VO 201 (optional, in accordance with the Designer's choice)
5. Overlap sealed with nail gun
6. Delta Amphibia BI-Mastic
7. RC structure suitable to withstand hydraulic pressures and exempt from defects

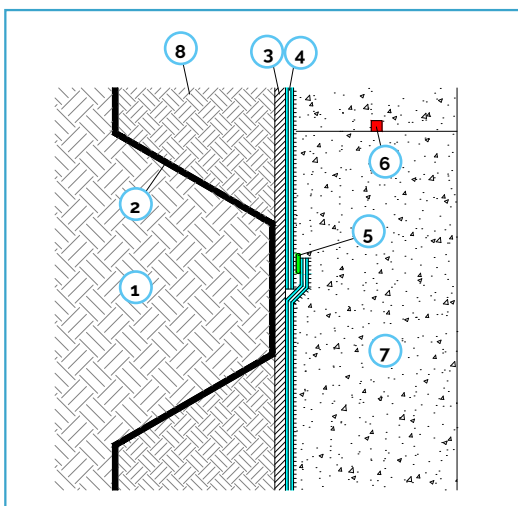

**RECOVERABLE METAL SHEET PILES WITH
 DELTA AMPHIBIA**

1. Soil
2. Recoverable metal sheet piles
3. Non-degradable rigid panel
4. Delta Amphibia
5. Overlap fixed with Delta Amphibia BI-Mastic
6. Koster Quellband
7. RC structure suitable to withstand hydraulic pressures and exempt from defects
8. Well compacted soil without voids

Application

3.15 VERTICAL APPLICATION ON PILE WALLS

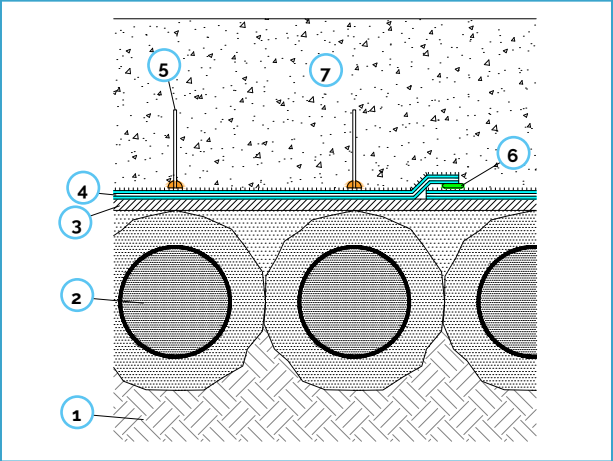
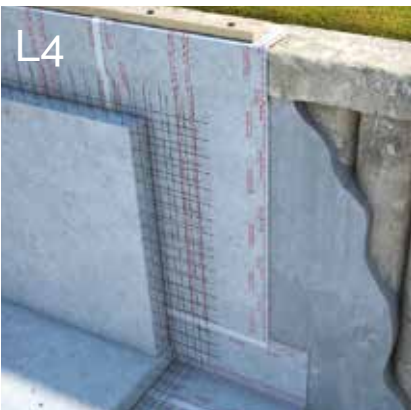
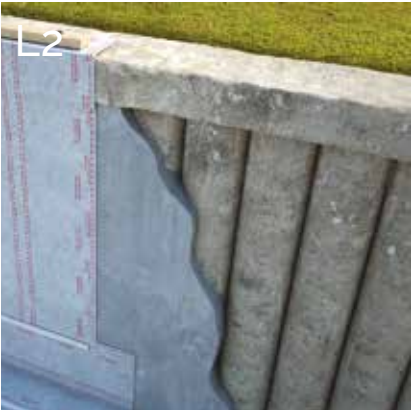

L1 MICROPILES WITH DELTA AMPHIBIA

- L2**
- L3** 1. Soil
- L4** 2. Micropiles
- 3. Smoothing or non-degradable rigid panel
- 4. Delta Amphibia
- 5. Connectors sealed with Delta Amphibia AKTI-VO 201
- 6. Delta Amphibia BI-Mastic
- 7. RC structure suitable to withstand hydraulic pressures and exempt from defects

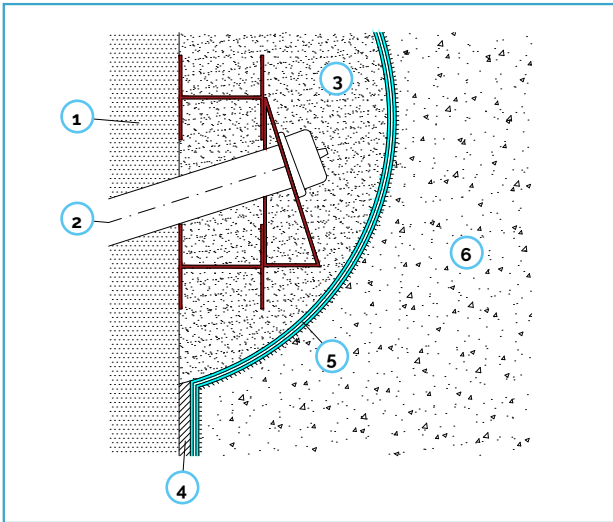

DELTA AMPHIBIA WITH ANCHORED PILING

- 1. Piling
- 2. Tieback anchor
- 3. Smoothing
- 4. Smoothing or non-degradable rigid panel
- 5. Delta Amphibia
- 6. RC structure suitable to withstand hydraulic pressures and exempt from defects

Application

3.16 JOINTS IN RETAINING WALLS

CONSTRUCTION JOINTS AND STRUCTURAL CRACK INDUCER

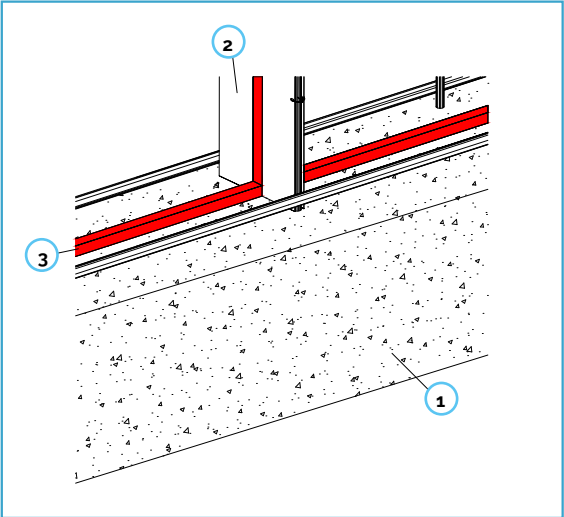

M1.2 | BREAK

- 1. RC structure suitable to withstand hydraulic pressures and exempt from defects
- 2. Break
- 3. Koster Quellband



APPLICATION OF SELF-SEALING STRUCTURAL CRACK INDUCER BREAK

Application

3.18 SLAB SEALING IN BLINDSIDE INSTALLATION

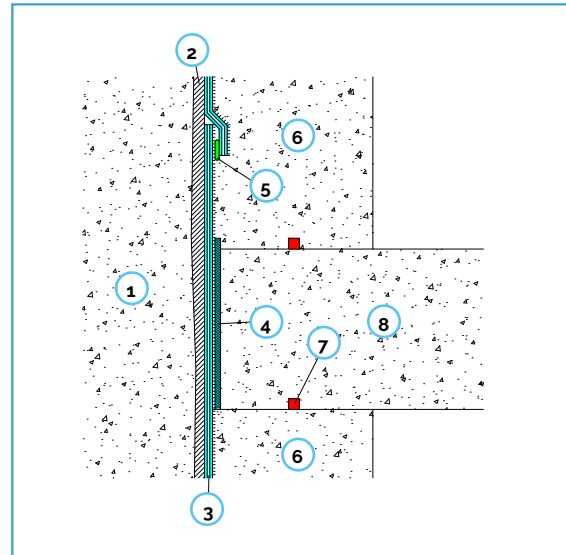

N1/N2 INTERMEDIATE SLAB AGAINST DIAPHRAGM WALL

1. Diaphragm walls
2. Smoothing or non-degradable rigid panel
3. Delta Amphibia
4. Joint Panel type R (*) or double Joint Panel type R glued/ fixed (on Delta Amphibia) and with their adjacent edges sealed with Delta Amphibia BI-Mastic/AKTI-VO 201
5. Delta Amphibia BI-Mastic
6. RC wall suitable to withstand hydraulic pressures and exempt from defects
7. Koster Quellband
8. Intermediate slab



APPLICATION OF HYDRO-EXPANDING RUBBER JOINT PANEL TYPE R FOR CONCRETE SLAB SEALING



Section 04 Service Penetrations

Service Penetrations

4.1 SEALING OF PENETRATION

OPEN BASEMENT EXCAVATION

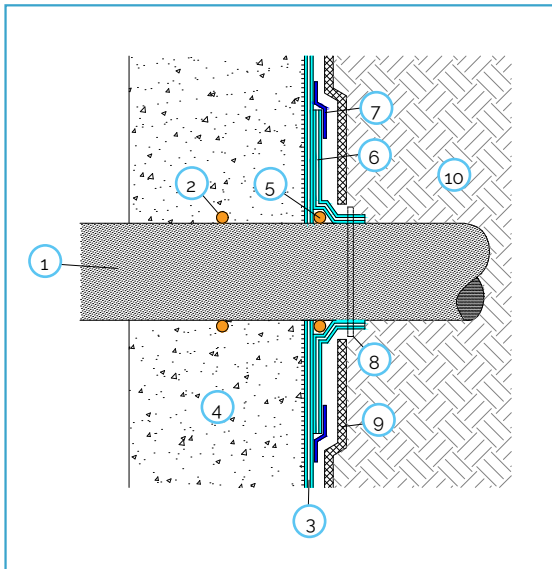
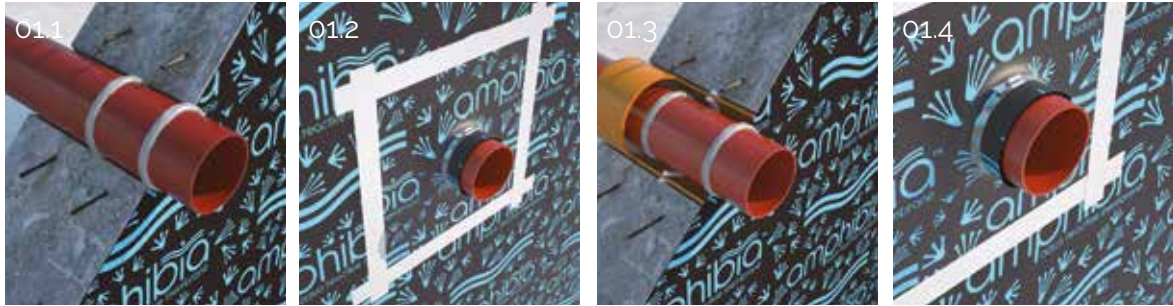

01.1/01.2 | DELTA AMPHIBIA MEMBRANE (1.3/1.6MM) PRE-APPLIED INSTALLATION - SEALING OF PENETRATIONS

1. Penetration (pre-applied installation)
2. Delta Amphibia AKTI-VO 201 already crystallized before pouring concrete
3. Delta Amphibia
4. RC structure suitable to withstand hydraulic pressures and exempt from defects
5. Delta Amphibia AKTI-VO 201 after casting concrete
6. Delta Amphibia patch all around the penetration
7. Delta Amphibia Safety Tape and/or Delta Amphibia BI-Mastic
8. Hose clamp
9. Rigid insulation panels or non-woven textile (min. 250 g/m²)
- 10.

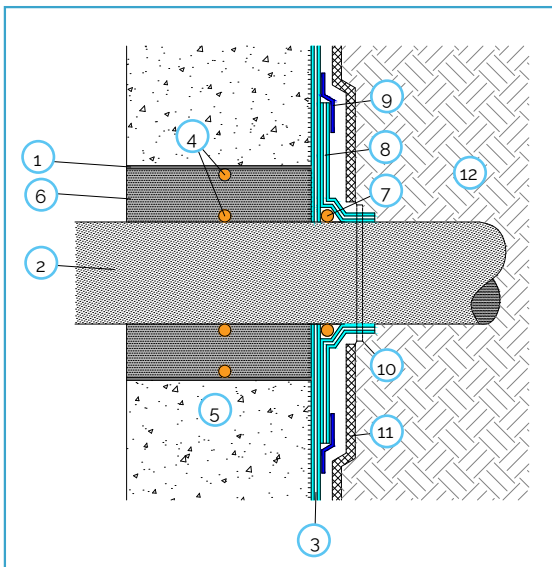

01.1/01.2 | DELTA AMPHIBIA MEMBRANE (1.3/1.6MM) PRE-APPLIED INSTALLATION - SEALING

1. Pipe sleeve installed before pouring concrete
2. Penetration
3. Delta Amphibia
4. Delta Amphibia AKTI-VO 201 already crystallised before pouring concrete
5. RC structure suitable to withstand hydraulic pressures and exempt from defects
6. Filling with Koster Repair Mortar Plus
7. Delta Amphibia AKTI-VO 201
8. Delta Amphibia 1.3mm / 1.6mm patch installed all around the penetration
9. Delta Amphibia Safety Tape and/or Delta Amphibia BI-Mastic
10. Hose clamp
11. Rigid non-degradable insulation panel or non-woven textile (min 250 g/m²)
12. Well compacted soil without voids

Service Penetrations

4.2 SEALING OF PENETRATION

BLINDSIDE

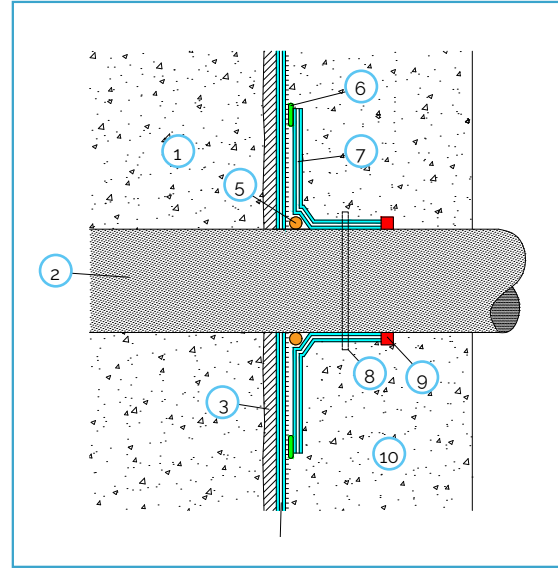
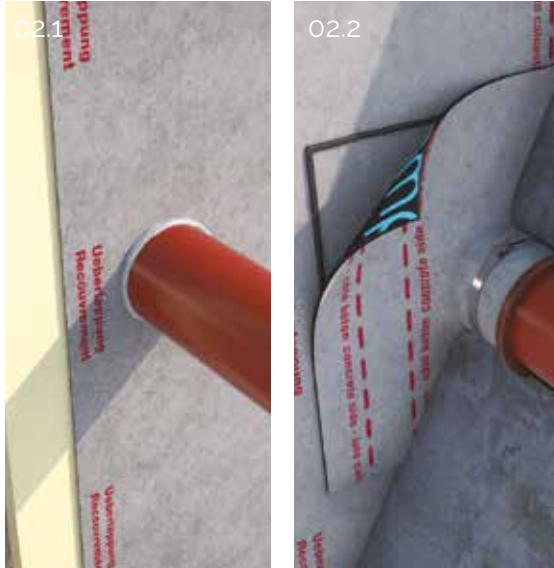

02.1/02.2 | DELTA AMPHIBIA INSTALLED ON SLURRY WALLS/EXISTING STRUCTURES- SEALING OF PENETRATIONS



1. Slurry wall/Existing structure
2. Penetration (pre-applied installation)
3. Smoothing or rigid non-degradable panels
4. Delta Amphibia
5. Delta Amphibia AKTI-VO 201
6. Delta Amphibia BI-Mastic
7. Delta Amphibia patch installed all around the penetration
8. Hose clamp
9. Koster Quellband
10. RC structure suitable to withstand hydraulic pressures and exempt from defects

SEALING PENETRATION WITH HYDRO-EXPANDING MASTIC AND DELTA AMPHIBIA SYSTEM

Service Penetrations

4.3 CONNECTIONS AND SEALING DETAILS

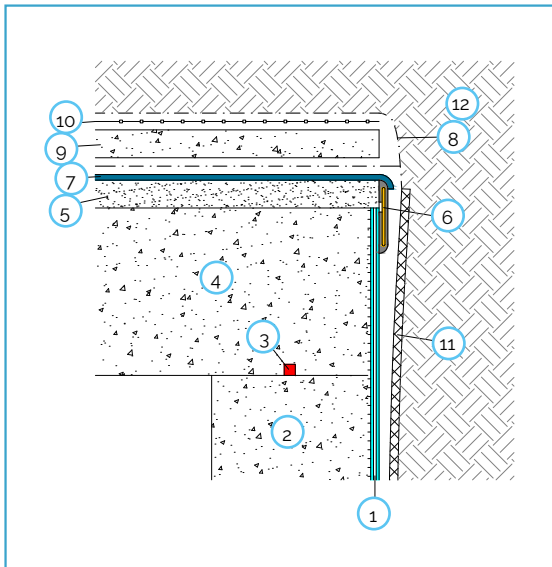
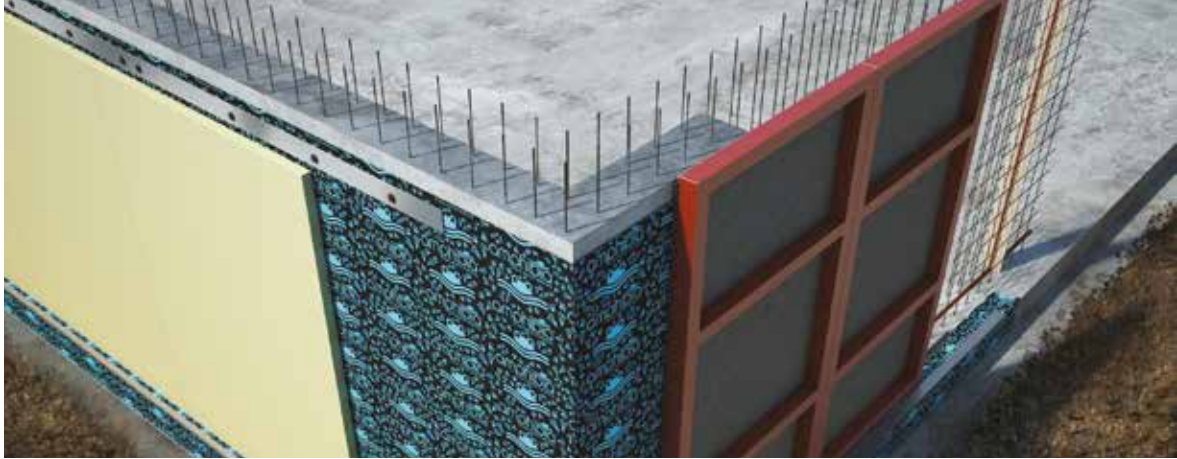

CONNECTION BETWEEN DELTA AMPHIBIA AND DELTA/KOSTER WATERPROOFING SYSTEMS

1. Delta Amphibia
2. RC wall suitable to withstand hydraulic pressures and exempt from defects
3. Koster Quellband
4. RC roof slab
5. Concrete sloped screed
6. Delta Amphibia Pressure Line
7. Koster NB4000 / Deuxan 2C
8. Separating protective element
9. Concrete protective screed
10. Suitable drainage system
11. Rigid non-degradable insulation panels or non-woven textile (min 250 g/m²)
12. Well compacted soil without voids

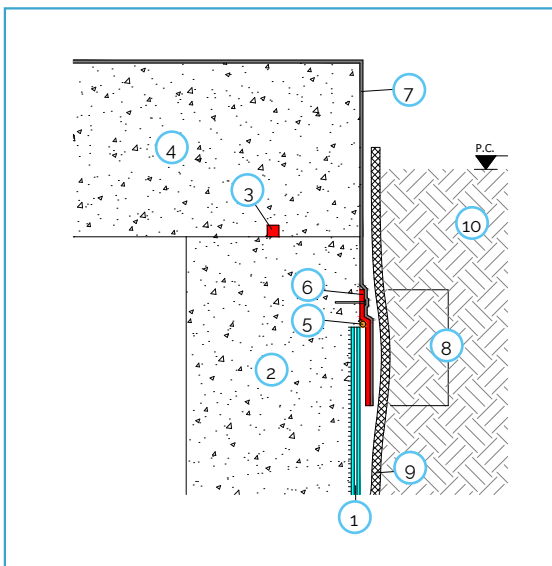

CONNECTION BETWEEN DELTA AMPHIBIA AND BITUMINOUS WATERPROOFING MEMBRANES

1. Delta Amphibia
2. RC wall suitable to withstand hydraulic pressures and exempt from defects
3. Koster Quellband
4. RC roof slab
5. Delta Amphibia AKTI-VO 201
6. Zinc-coated metal flashing (min 20 cm)
7. Bituminous waterproofing membrane
8. Part of bituminous waterproofing sheet membrane to be torched onto the metal flashing
9. Rigid non-degradable insulation panels or non-woven textile (min 250 g/m²)
10. Well compacted soil without voids

HEAD OFFICE

Delta House, Merlin Way, North Weald, Epping, Essex, CM16 6HR
01992 523 523 | info@deltamembranes.com | www.deltamembranes.com

© 2022 Delta Membrane Systems Ltd All Rights Reserved