

5 55 264 5

eibe ibondo Aerial cableway Sierra Duo 20 m







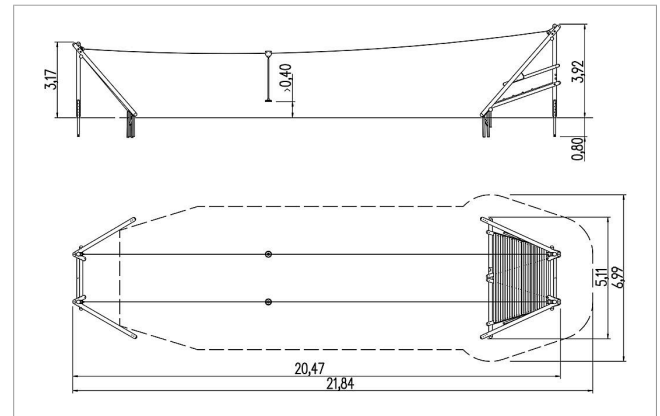

made in germany

3+

Scope of delivery

- 2 cable bolts: hot-dip galvanised steel
- 2 cable tensioning devices: hot-dip galvanised steel
- 2 aerial cable way carriages: stainless steel
- 2 carrying cables L 20 m: steel rope
- 4 braking springs: spring steel
- 2 pendulum seats: rubber
- 2 face plates: HPL
- 1 start platform: pressure impregnated SW
- Basic construction: pressure impregnated SW
- Post shoes: hot-dip galvanised steel



	Material	SW pi
	Foundation level	FL 3
	Minimum space	2184x699x392 cm
	Free falling height	146 cm
	Impact protection net	125 m ²
	Foundations	8x CF
	Assembly	3 people/7 h
	Largest section	Ø 16x532 cm
	Heaviest section	100 kg