

5 59 117 0

eibe playo Large Train Tender

made in germany

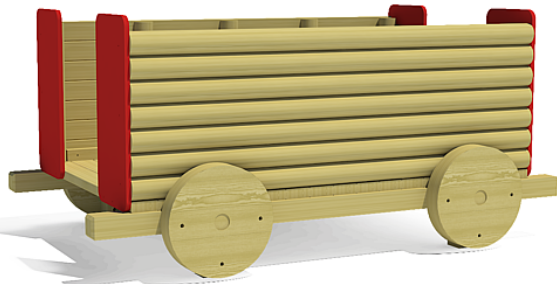







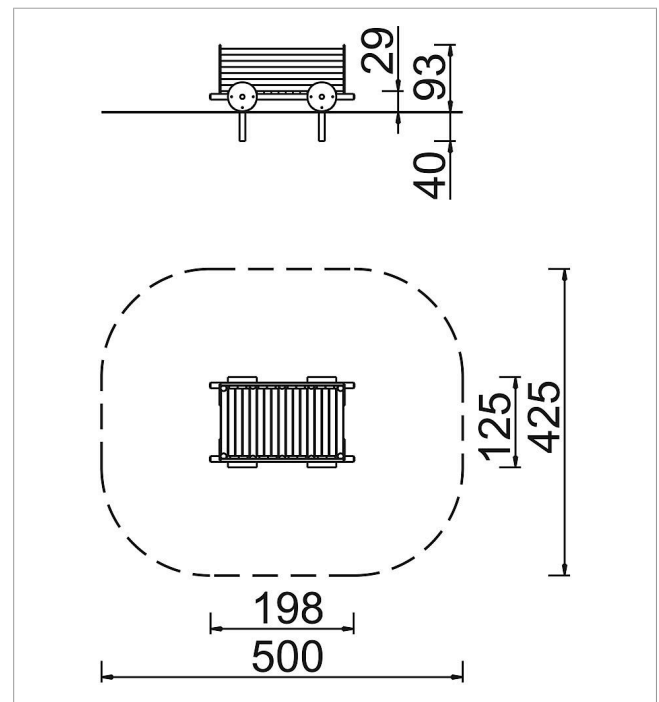

3+

Scope of delivery

- 2 side walls: SW
- 1 platform floor: SW
- 4 wheels: SW
- 4 side elements: MDF exterior



	Material	SW pi
	Foundation level	-
	Minimum space	500x425x209 cm
	Free falling height	29 cm
	Impact protection net	19,5 m ²
	Foundations	-
	Assembly	-
	Largest section	212x110x50 cm
	Heaviest section	140 kg