

5 58 021 0







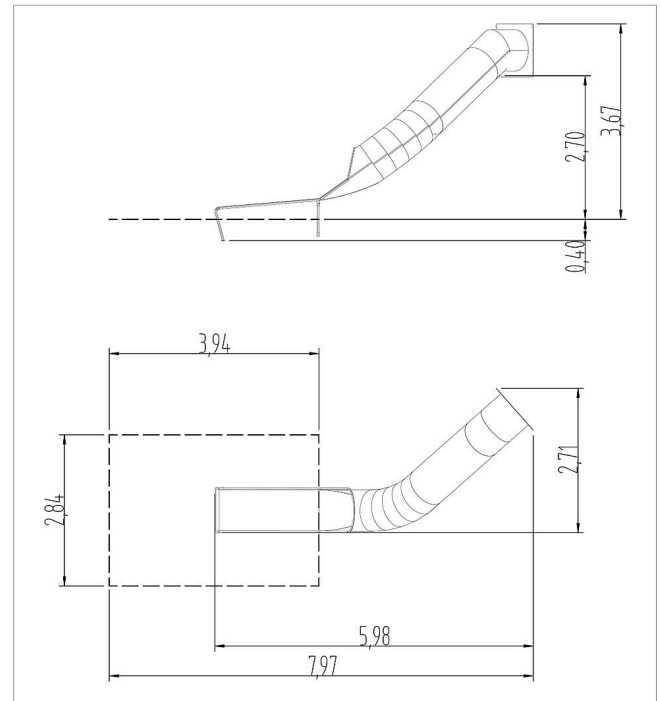

**eibe Tubular Add-on
Slide with Curve V2A,
PH 190**
made in germany

3+

Scope of delivery

1 slide PH 190: V2A



	Material	Stainless steel
	Foundation level	FL 3
	Minimum space	705x284x370 cm
	Free falling height	70 cm
	Impact protection net	7 m ²
	Foundations	2x CF
	Assembly	3 people/2 h
	Largest section	Ø 80x520 cm
	Heaviest section	286 kg