

5 55 118 0

eibe rope tree Aerie with metal posts







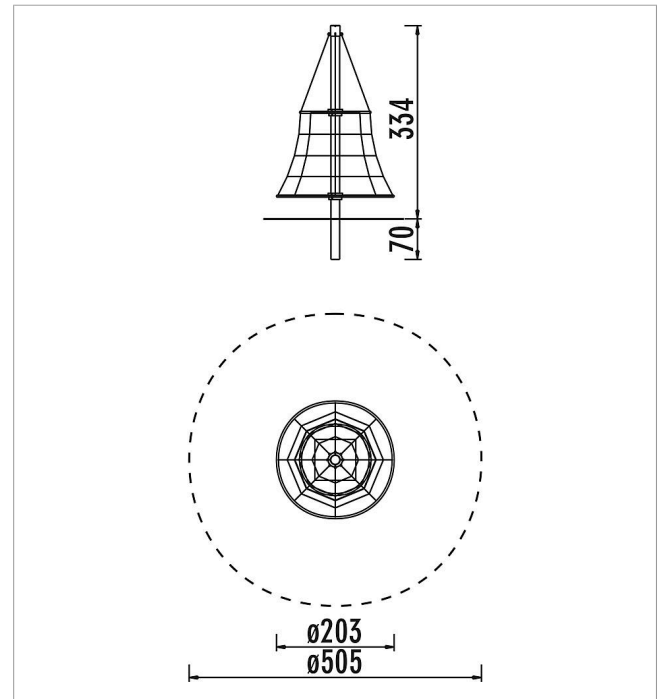

made in germany

3⁺

Scope of delivery

1 rope tree Aerie: aluminium, polyester-coated steel cable



	Material	Steel
	Foundation level	FL 3
	Minimum space	Ø 505x387 cm
	Free falling height	187 cm
	Impact protection net	21 m ²
	Foundations	1x CF
	Assembly	2 people/1,5 h
	Largest section	Ø 15x400 cm
	Heaviest section	60 kg