

5 55 315 5

## eibe balance Jive Tibetan Bridge







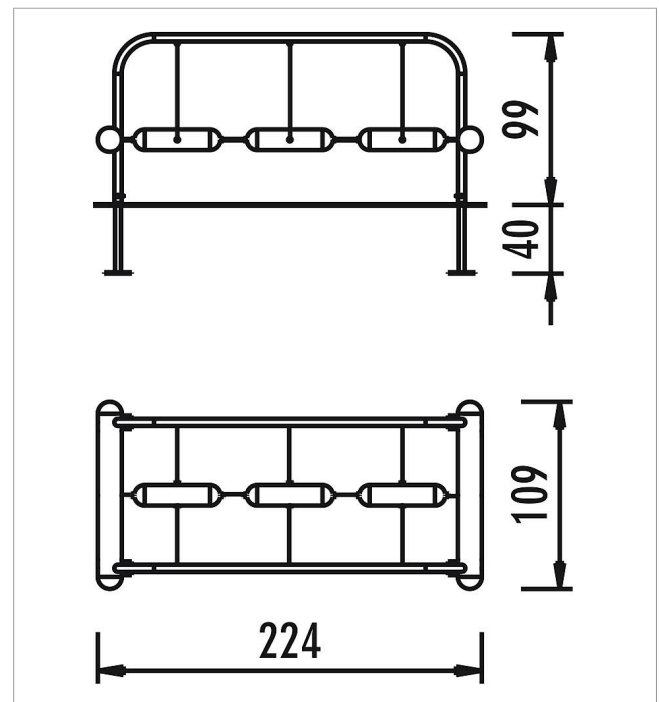

made in germany



### Scope of delivery

- 2 hand rails: stainless steel
- 1 chain suspension: hot-dip galvanized steel
- 2 crossbeams: pressure-impregnated pine
- 3 stepping beams: pressure-impregnated pine
- Post shoes: hot-dip galvanized steel



	Material	SW pi
	Foundation level	FL 1
	Minimum space	224x109x225 cm
	Free falling height	45 cm
	Impact protection net	-
	Foundations	4x CF or 4x PFs
	Assembly	1 person/2 h
	Largest section	242x116xØ 42 cm
	Heaviest section	40 kg