

5 55 316 5

eibe balance Samba Net Footbridge

made in germany











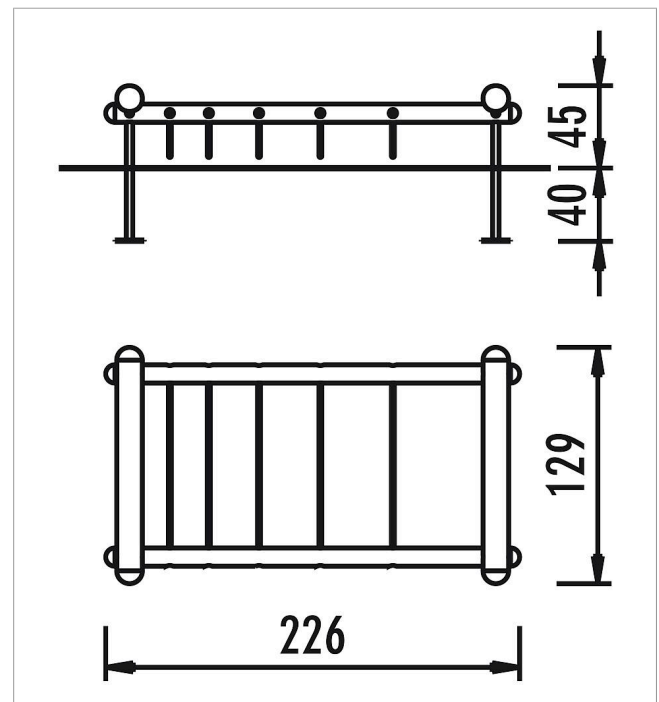

Scope of delivery

5 ropes: polyester-coated steel cable

Wood construction: pressure impregnated pine

Post shoes: hot-dip galvanised steel



	Material	SW pi
	Foundation level	FL 1
	Minimum space	226x129x225 cm
	Free falling height	45 cm
	Impact protection net	-
	Foundations	4x CF or 4x PFs
	Assembly	1 person/2 h
	Largest section	226xØ 10 cm
	Heaviest section	12,5 kg