



5 55 010 5

eibe ibondo Hexagonal System 200







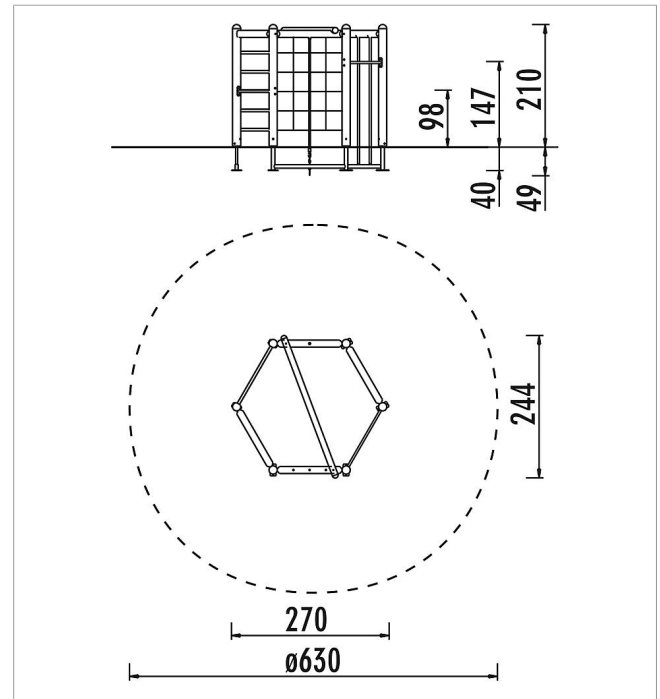

made in germany

4+

Scope of delivery

- 1 rung element: SW and ash
- 2 horizontal bars: hot-dip galvanised and powdered steel
- 2 sliding poles: powder-coated steel
- 1 climbing net: polyester-coated steel cable
- 1 climbing rope: polyester-coated steel cable
- Wooden construction H 200 cm: SW
- Post shoes: hot-dip galvanised steel



	Material	SW pi
	Foundation level	FL 1
	Minimum space	Ø 630x395 cm
	Free falling height	205 cm
	Impact protection net	31,5 m ²
	Foundations	7x CF or 7x PFs
	Assembly	2 people/3 h
	Largest section	250x139x14 cm
	Heaviest section	120 kg