

5 67 233 0







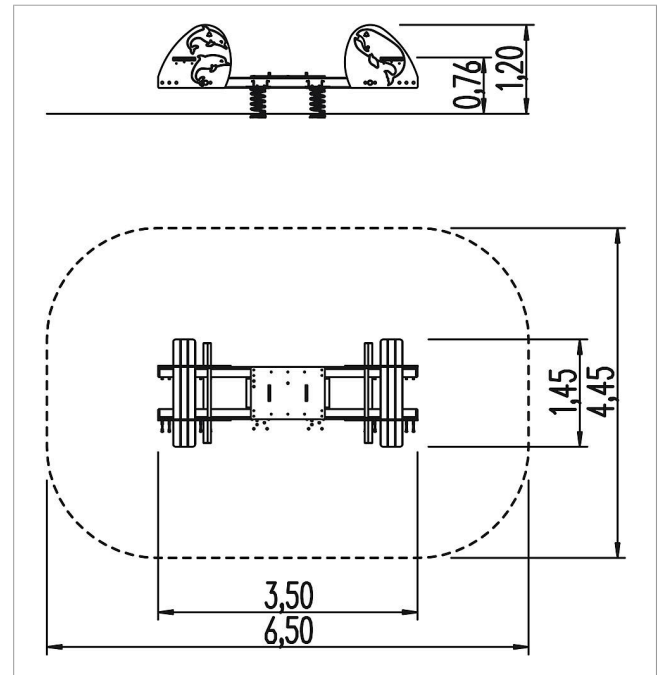

eibe ibondo multi-spring rocker Dolphin and whales
made in germany

3+

Scope of delivery

1 spring rocker body: SW, HPL
4 springs: spring steel



	Material	SW pi
	Foundation level	FL 3
	Minimum space	650x445x278 cm
	Free falling height	100 cm
	Impact protection net	26,5 m ²
	Foundations	4x 5632280 + 4x CF
	Assembly	2 people/1,5 h
	Largest section	350x130x89 cm
	Heaviest section	110 kg