

5 67 110 0

eibe playo Double Spring Rocker Frog







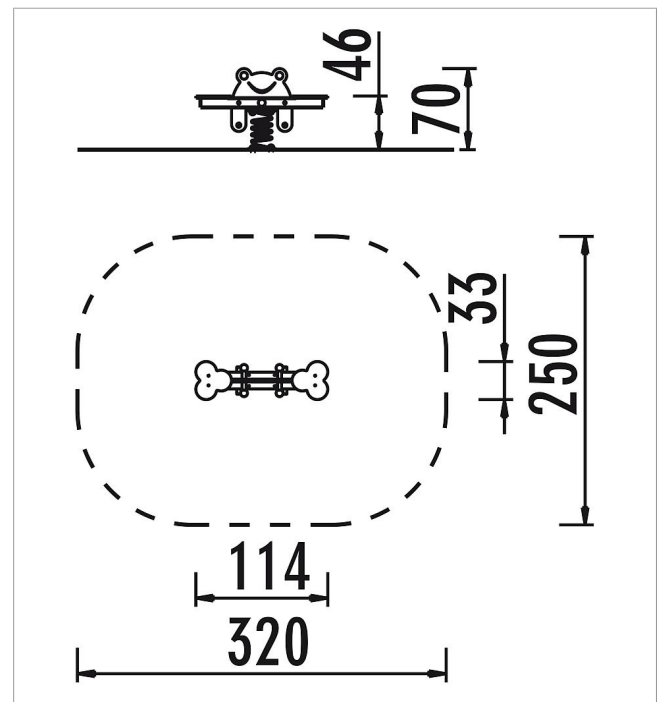

made in germany

3+

Scope of delivery

- 1 spring rocker animal body: pressure-impregnated SW, PE
- 1 spring: spring steel



	Material	SW pi, PE
	Foundation level	FL 3
	Minimum space	320x250x227 cm
	Free falling height	66 cm
	Impact protection net	7,5 m ²
	Foundations	1x 5632280 + 1x CF
	Assembly	2 people/1 h
	Largest section	115x35x30 cm
	Heaviest section	15 kg