

LOUDSORBA®

Acoustic Ceiling Hanging Panels



INNOVATIVE DESIGN & CLASS A ABSORPTION

LOUDSORBA® acoustic “ceiling hanging panels” are an innovative method of absorbing reverberant noise in rooms without the visual appearance of just another one of those boring suspended ceilings.

The stunning visual effect of acoustic ‘clouds’ on a ceiling space leaves an occupant or visitor with an impression of flair and forward thinking on behalf of the designer of the room or hall.

SOUNDSORBA®
ACOUSTIC PRODUCTS

CLOUDSORBA®

Acoustic Ceiling Hanging Panels

DESCRIPTION

Ceiling Clouds are a very effective treatment for the reduction of sound in building areas. The Cloudsorba® not only allows one to achieve excellent acoustic results but also superb visual characteristics.

Cloudsorba® acoustic panels are available in a wide range of sizes and shapes, and is a high density 25mm thick glass fibre acoustic core board. This is faced on the visible face and edges with a decorative acoustic fabric which is available in a wide range of colours. Cloudsorba® can be manufactured up to a size of 2700mm x 1200mm. The acoustic fabric is bonded to the face and around all four sides to give a superb frameless appearance. The Cloudsorba® panel system will come with the spiral springs, 2m cables and the eyelet hooks. 40mm thick version is also available.

Dimension tolerance +/- 3mm

FIRE

Cloudsorba® - Recycled glasswool acoustic board provides very good fire resistant properties. This is fire rated as Class O to BS476: Part 6. Standard fabric facing comply with Class 1 to BS476: Part 7. Class O fabric can be used on request.

MAINTENANCE

The Cloudsorba® hanging clouds can be cleaned using a vacuum cleaner. Any slight dirt marks may be cleaned with a damp cloth or a proprietary cleaner.

WEIGHT

Cloudsorba®: 3kg/m².

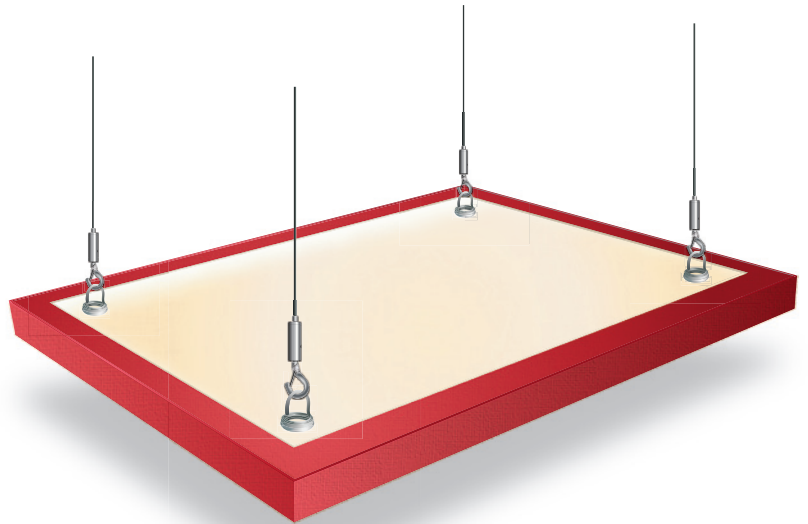

ACOUSTIC PERFORMANCE

Sound Absorption Coefficient - Cloudsorba® (with 100mm suspension)								Sound Absorption Class
Frequency (Hz)	125	250	500	1000	2000	4000	NRC	
Cloudsorba®	0.45	0.85	0.95	1.00	1.00	1.00	0.95	A



Multi-coloured cloud-shaped Cloudsorba® panels featured in a school classroom.

CLOUDSORBA®

STANDARD SHAPES & SIZES

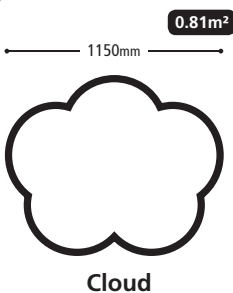
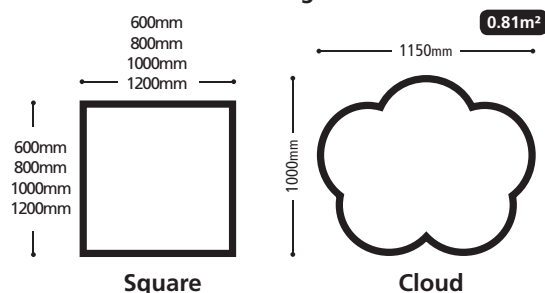
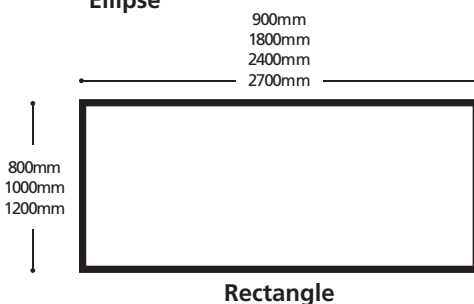
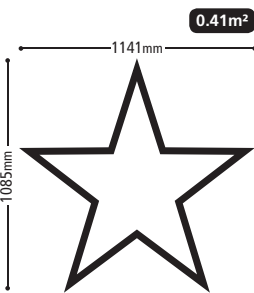
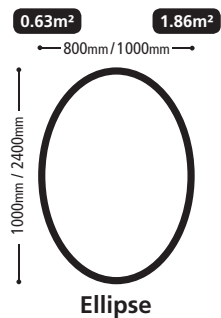
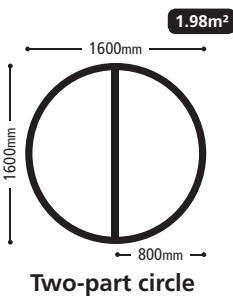
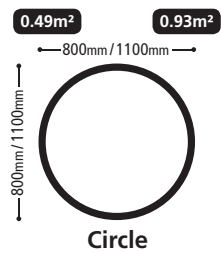
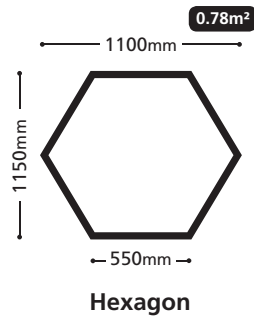
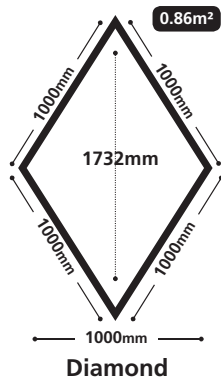
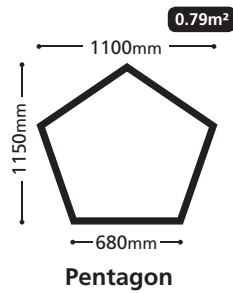
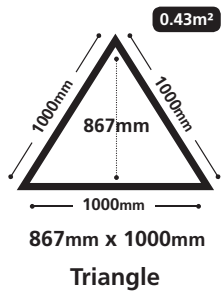

Keeping it Green



Soundsorba Glass fibre sound absorbing boards consist of recovered household glass and recycled glass fibre.

The fabric range used is made from 100% recycled materials saving virgin raw materials, reducing waste to landfill and minimising our damage to the environment. Made using sustainable manufacturing techniques, including green electricity, comprehensive energy and effluent management, borehole water and on-going waste saving initiatives,

Second Nature fabrics leave a lighter environmental footprint.

Our ethos is focused on continuing to achieve the highest environmental standards for our operations, products and innovations, engaging with, and acting responsibly towards, our local community and wider interest groups.



Custom Cloudsorba® panels in the gym of Bedford Modern School

CLOUDSORBA® - ECOPAINT SUSPENDED ACOUSTIC CEILING PANELS



This version of Cloudsorba has an Arctic white speckled painted finish on all 6 sides, giving a crisp visually attractive appearance. The panels are normally fitted as individual stand-alone panels as a design feature, with the distance between the adjacent panels to suit the customer needs. The perimeter of the panels is square edged.

These panels are NOT designed for impact resistance.

NOMINAL DIMENSIONS

Standard sizes: 1200 x 1200 x 40mm thick
and also: 2400 x 1200 x 40mm thick

Circle Panels: 800 diameter x 40mm thick
1200 diameter x 40mm thick



ACOUSTIC RATING: These are Class A sound absorbers. With 200mm airgap:

Frequency (Hz)	125	250	500	1000	2000	4000	NRC
Absorption Coefficient (α)	0.25	0.75	0.95	1.00	1.00	1.00	1.00

FIRE: The panels are Class 0 fire rated to BS476: Part 6.

WEIGHT: Nominal 4 kg/m²

The standard Cloudsorba - Ecopaint surface finish comes in a visually pleasing Arctic white speckled painted finish. However, they can be emulsion spray painted on site to any colour with little significant effect on acoustical performance. The panels can be painted for aesthetic reasons or even in the future to cover any dirty marks or maybe discolouration from cigarette smoke, etc. It is important that the paint is water based matt emulsion painted and is applied in a very light mist spray coat so that the acoustics are not affected.

INSTALLATION TO CEILINGS

Clean white gloves must be used when handling these panels to avoid marking the panels.



Every endeavour has been made to ensure that the information given herein is true and reliable but is only given for guidance. The company cannot accept any responsibility for loss or damage that may result from the use of the information, due to the possibility of variations of processing or working conditions and of workmanship outside our control. Users are advised to confirm the suitability by their own tests. All panels are manufactured to our standard dimensional tolerances of +/- 3.0 mm.



Cloudsorba® - Ecopaint ceiling clouds in an office.



Circular Cloudsorba® - Fabric ceiling clouds in a library.













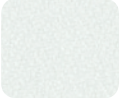









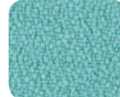
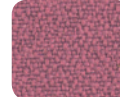

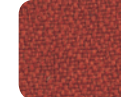

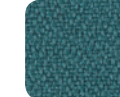

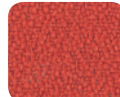



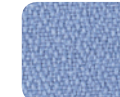

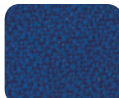
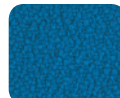

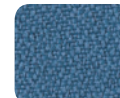
A combination of circular and teardrop shaped Cloudsorba® - Fabric ceiling clouds applied in an office space.

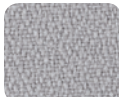
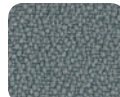

Square, circle and the larger two-part circle Cloudsorba® - Fabric ceiling clouds applied to a canteen/restaurant environment.

FABRIC COLOUR RANGE - LUCIA



















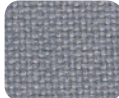



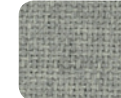









 Adobo YB165 LR = 85.8	 Oyster YB107 LR = 64.8	 Turtle YB098 LR = 39.14	 Apple YB096 LR = 37.16	 Solano YB088 LR = 36.13	 Madura YB156 LR = 43.08	 Sandstorm YB302 LR = 22.78	 Reef YB085 LR = 45.6
 Aruba YB093 LR = 37.39	 Belize YB105 LR = 10.49	 Campeche YB301 LR = 27.43	 Bridgetown YB102 LR = 11.34	 Diablo YB101 LR = 6.99	 Jamaica YB027 LR = 7.2	 Calypso YB106 LR = 6.4	 Windjammer YB047 LR = 9.02
 Taboo YB045 LR = 4.15	 Tobago YB030 LR = 3.11	 Lobster YB087 LR = 11.55	 Tortuga YB168 LR = 30.46	 Montserrat YB011 LR = 7.94	 Arecibo YB099 LR = 45.31	 Bermuda YB084 LR = 32.9	 Mauve YB069 LR = 14.64
 Tarot YB090 LR = 3.01	 Ocean YB100 LR = 3.56	 Scuba YB089 LR = 6.37	 Bluebell YB097 LR = 16.91	 Martinique YB004 LR = 12.79	 Steel YB095 LR = 23.03	 Bluefield YB021 LR = 8.27	 Marianna YB157 LR = 33.48
 Tequilla YB038 LR = 14.56	 Slip YB094 LR = 27.94	 Blizzard YB108 LR = 12.23	 Havana YB009 LR = 2.26	 Sombbrero YB046 LR = 4.36	 Costa YB026 LR = 3.38	 Buru YB170 LR = 24.37	 Rum YB086 LR = 38.32

LR = Light Reflectance

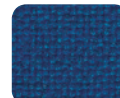
FABRIC COLOUR RANGE - CARA



 Lomond EJ192 LR =	 Glass EJ004 LR = 46.32	 Clan EJ169 LR = 62.3	 Vit EJ184 LR =	 Beltane EJ193 LR =	 Shetland EJ191 LR =	 Hillswick EJ190 LR =	 Denny EJ196 LR =
 Maree EJ195 LR =	 Chaucer EJ172 LR = 25.94	 Ronay EJ189 LR =	 Easdale EJ188 LR =	 Austen EJ173 LR = 39.8	 Spray EJ033 LR = 16.46	 Lora EJ187 LR =	 Dolphin EJ105 LR = 35.65
 Lerwick EJ194 LR =	 Portland EJ016 LR = 14.26	 Fair Isle EJ186 LR =	 Inverness EJ175 LR = 31.48	 Lead EJ104 LR = 18.39	 Staffa EJ185 LR =	 Galilee EJ125 LR = 18.96	 Adriatic EJ154 LR = 8.79
 Lossie EJ197 LR =	 Merrick EJ048 LR = 12.23	 Carron EJ015 LR = 8.67	 Clunie EJ180 LR = 4.13	 Tummel EJ038 LR = 6.65	 Pitlochry EJ076 LR = 8.59	 Walten EJ011 LR = 3.46	 Black EJ138 LR = 1.65

LR = Light Reflectance

Due to printing reproduction restraints, differences may appear between colours printed above and the actual product. Sample fabric colour charts are available on request. Colour shade differences may occur between different production batches.

Please state the height and width dimensions of each panel when ordering. e.g. 1050mm wide x 1710mm high. The fabric has a directional weave, hence we must be notified of height and width of each panel.

Please ask for up-to-date fabric swatch as colour options are constantly being updated.

INSTALLATION

The installation time is fast as the Cloudsorba® acoustic Panels are simply suspended by steel wires from the soffit by means of special spiral hooks which are fitted in the rear of the acoustic panels. Also, this means that non-specialist fitters can be used to carry out the installation. The depth in suspension is simply adjusted by adjusting the length of the steel suspension wire. This also allows the panels to be installed at sloping angles if required, again adding to the visual design possibilities. The spiral hooks should be placed between 200mm to 300mm from the edge of the Cloudsorba® panels. For sloping panel installations, we recommend the largest panels to be no more than 700mm x 700mm. The Cloudsorba® panel system will come with the spiral springs, 2m cables and the eyelet hooks.

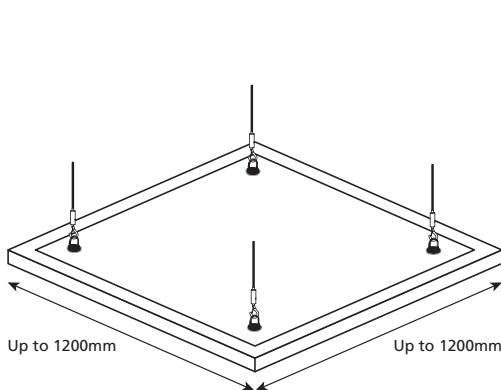
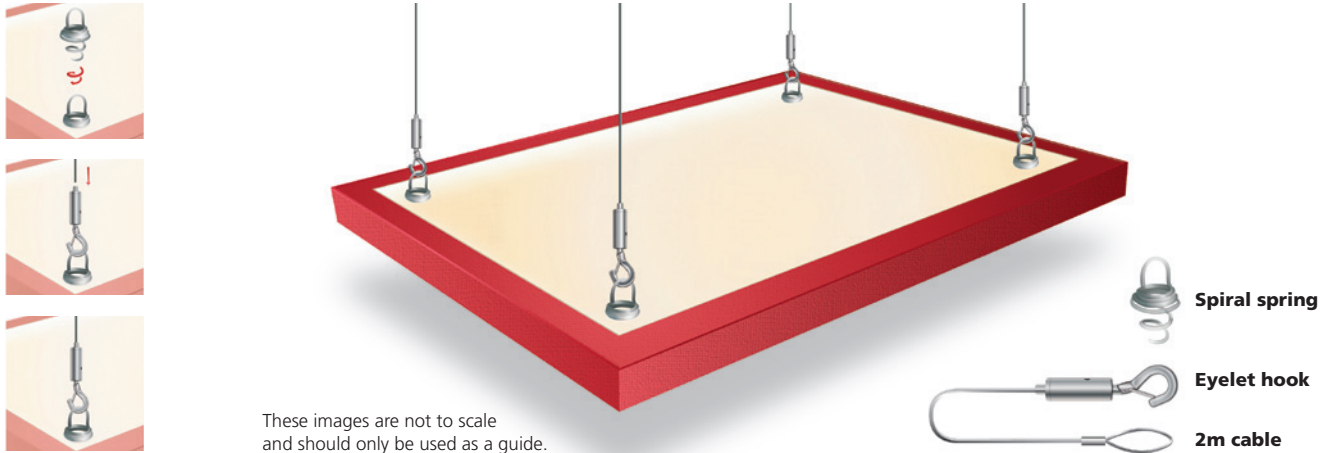

For Cloudsorba® panels up to 1200 x 1200mm size, use 4 suspension cables.

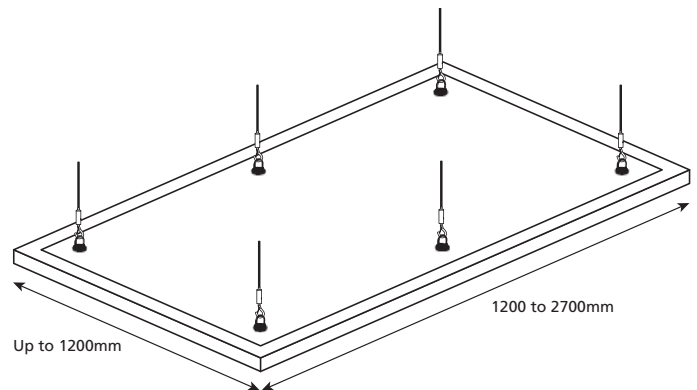

For Cloudsorba® panels of greater size than 1200 x 1200mm size, use 6 suspension cables.

GUIDE SPECIFICATION

A. General

1. All Cloudsorba® acoustic panels should be installed in accordance with the manufacturer's recommendations.
2. All necessary hardware and accessories for the complete job installation to be furnished by the contractor.
3. Installation of the panels should not begin until all the wet work, such as plastering, concrete, etc. is completely dry. The panels are designed for storage and installation under standard occupancy conditions from 10°C to 20°C and not more than 75% R.H in an enclosed building.
4. The contractor shall be responsible for the examination and acceptance of all surfaces and conditions prior to the acoustical panel installation.

B. Product

1. Install Cloudsorba® using the correct number of Cloudsorba® spiral hook system.
2. The Cloudsorba® panels size to bemm long xmm wide in shape.
3. Finish: The Cloudsorba® acoustic panels to be in (YB/EJ.....) Soundsorba standard fabric colour.

C. Supplier

1. Cloudsorba® acoustic panels systems as supplied by Soundsorba Ltd.
27-29 Desborough Street, High Wycombe, Bucks HP11 2LZ UK
TEL: +44 (0) 1494 536888 FAX: +44 (0) 1494 536818
EMAIL: info@soundsorba.com www.soundsorba.com

Prices and Conditions of Sale

Our standard terms and conditions (copy available on request) apply to all orders. Since Soundsorba Limited exercise no control over the use of its products, no legal responsibility is accepted for any application of their products. We reserve the right to change specifications without notice as our policy is one of continuous improvement. Copyright Soundsorba Limited 2015.