

Em-Trim GRP roof edge trim

Colourfast, simple to install and maintenance free



Key features

- Neat unobtrusive appearance
- Simple to handle, work and install
- Negligible coefficient of expansion, eliminating the problem of membranes tearing at the trim joint
- Can withstand hot bitumen and mastic asphalt
- Corrosion resistant
- Higher strength to weight ratio than its metal counterparts
- Maintenance free
- Pre-formed 90° internal and external angles available
- Choice of 17 profiles in black, white and grey (DE50, L100/100, L40/40 and Flat bar – black only)
- Further colours available to special order
- Competitively priced
- Complementary range of fixings, sealant and drill-bits available

Profiles Flat arm profiles for built-up felt roofing systems (F)

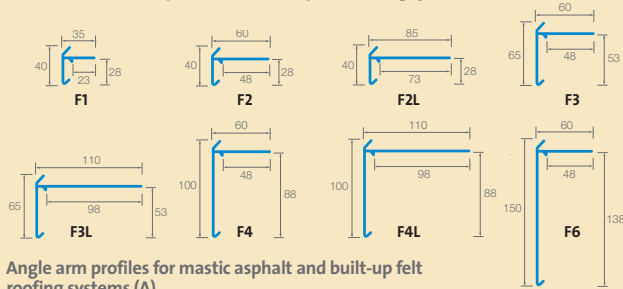

Angle arm profiles for mastic asphalt and built-up felt roofing systems (A)

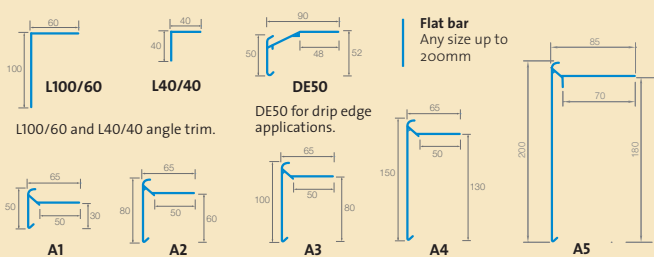

T-Trim aluminium roof edge trim

Economical and simple to install



Key features

- Neat unobtrusive appearance
- Simple to handle, work and install
- Mill finish ex-stock and available anodised or polyester powder coated to order
- High strength to weight ratio
- Maintenance free
- Pre-formed 90° internal and external angles available
- Available in a choice of 13 profiles
- Competitively priced
- Complementary range of fixings, sealant and drill-bits available

Profiles

For built-up felt roofing systems

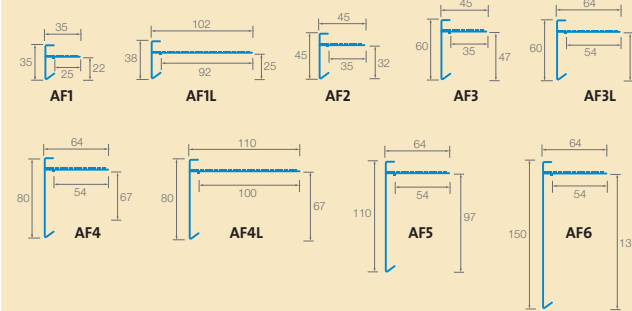

For mastic asphalt roof finishes

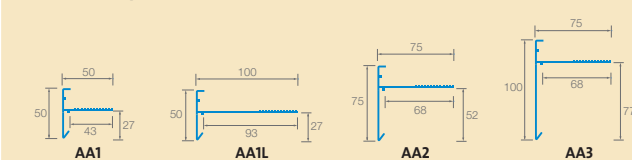

T-Bar and Em-Bar termination bars

Eliminates the need for lead flashings



Key features

- Economical alternative to traditional lead flashing, avoiding the need to cut chases
- Suitable for built-up felt and mastic asphalt
- Choice of GRP or aluminium
- Fix through or cover flashing type available
- Neat unobtrusive appearance
- Simple to handle, work and install
- Complementary range of fixings, sealant and drill-bits available

Profiles

GRP Em-Bars

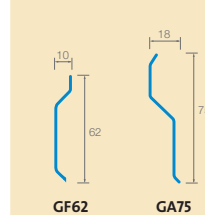

Aluminium T-Bars

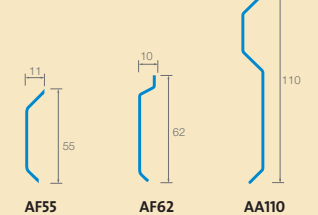

Fixings, sealant and drill-bits

A complementary range of fixings, sealant and drill-bits is available to assist in the correct installation of Em-Trim, T-Trim and termination bar systems.



Flat roof accessories

Paving slab supports, drainage outlets, pipe sleeves and breather vents

Key features

- Our comprehensive range of flat roofing accessories is ISO 9002 compliant and offers a 10 year guarantee
- Complete range (except T-Pad and Em-Pad) manufactured in EPDM. Some products are also available in PVC-u and PP
- EPDM (ethylene propylene diene rubber) products are suitable for use with built-up felts and mastic asphalt finishes
- PVC-u (polyvinyl chloride) products are for use with PVC single ply membranes
- PP (polyolefin polypropylene) products are for use with TPO single ply membranes

Em-Pad adjustable paving support pads

Em-Pads are a range of solid polypropylene adjustable paving support pads, offered in a range of six sizes providing support heights from 35-200mm. Suitable for use with gradients up to 5%. The support head incorporates spacing nibs to maintain a consistent drainage gap between paving.

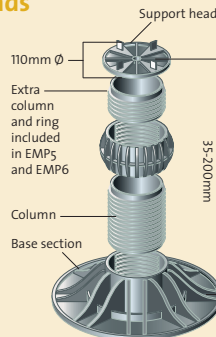

Ref. No	Height range	Base diameter
EMP1	35-55mm	200mm
EMP2	55-70mm	200mm
EMP3	70-110mm	230mm
EMP4	110-150mm	230mm
EMP5	150-170mm	230mm
EMP6	170-200mm	230mm
EMPxx	up to 600mm	230mm

T-Pad paving support pads

T-Pads incorporate spacing nibs to maintain a consistent drainage gap between paving. The TP2 can be stacked to allow a variable space beneath the paving. TP3 shims are available for fine height adjustment of TP2 pads.

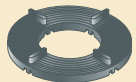

TP1
Rubber
(120mm Ø x 9mm)

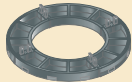

TP2
Polypropylene
(150mm Ø x 15mm)

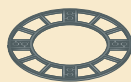

TP3
(150mm Ø x 3mm)

T-Pipe flat flange outlets

T-Pipe flat flange outlets are versatile flat roof drainage outlets formed in EPDM, PVC-u or PP. The ribbed push-in spigot provides a connection to pipework. These outlets suit all forms of flat roof, and are also ideal for installation in, for example, wide valley gutters.

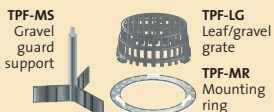

TPF-BG
Balloon guard

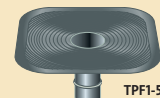

TPF1-50
180mm deep

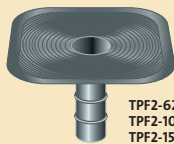

TPF2-62.5, TPF2-75, TPF2-100, TPF2-110, TPF2-150
250mm deep

T-Pipe sump flange outlets

Made to the same technical specification as the flat flange outlet. The sump increases the rate of rainwater flow into the drain. The long tail pipe is ideal for installation in deep roof slabs.



TPS-LG
Leaf/gravel grate

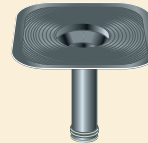

TPS/75, TPS/100, TPS/150
330mm deep



TPS-MR
Mounting ring

T-Pipe mechanical fix flange outlet

Incorporates a clamping collar that creates a secure, leakproof seal between the roofing membrane and rainwater outlet. The roofing membrane is dressed over the outlet flange and secured by the mechanically fixed clamping collar which engages over threaded stainless steel studs. The leaf guard simply clips onto the clamping collar.

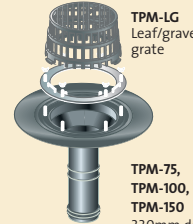

TPM-LG
Leaf/gravel grate

TPM-75, TPM-100, TPM-150
330mm deep

T-Pipe horizontal outlets

Designed for application at the angle of two intersecting surfaces. They can be installed to provide either vertical or horizontal take-off.

TPH-100/45
100x100mm
45°

TPH-LG/100-110
Leaf/gravel grate for 100x100mm/110mm Ø

TPH-LG/65
Leaf/gravel grate for 65x100mm

TPH-65, TPH-100
100x100mm
90°

TPHC-100
90° connector 100x100mm to 100 Ø

TPHC-65
90° connector 65x100mm to 100 Ø

TPH-110 PVC
110mm Ø 90°

TPHC-110
90° connector for 110mm Ø to 110mm Ø

T-Sleeve pipe sleeves

Available for situations where pipework passes through the roof structure. Can accommodate a wide range of diameters from 34mm to 125mm.

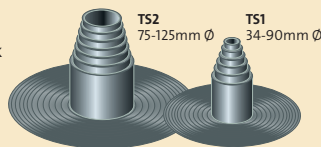

TS2
75-125mm Ø

TS1
34-90mm Ø

T-Vent breather vents

Available in either EPDM or PVC-u. These vents are suitable for installation in built up or asphalt roofing, and allow water vapour to escape from the structure. The vents release vapour pressure, thus avoiding blistering of the membrane.

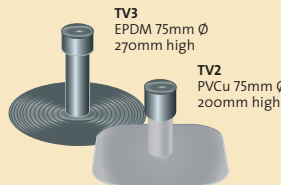

TV3
EPDM 75mm Ø
270mm high

TV2
PVCu 75mm Ø
200mm high

Trims & accessories

Brochure 2014

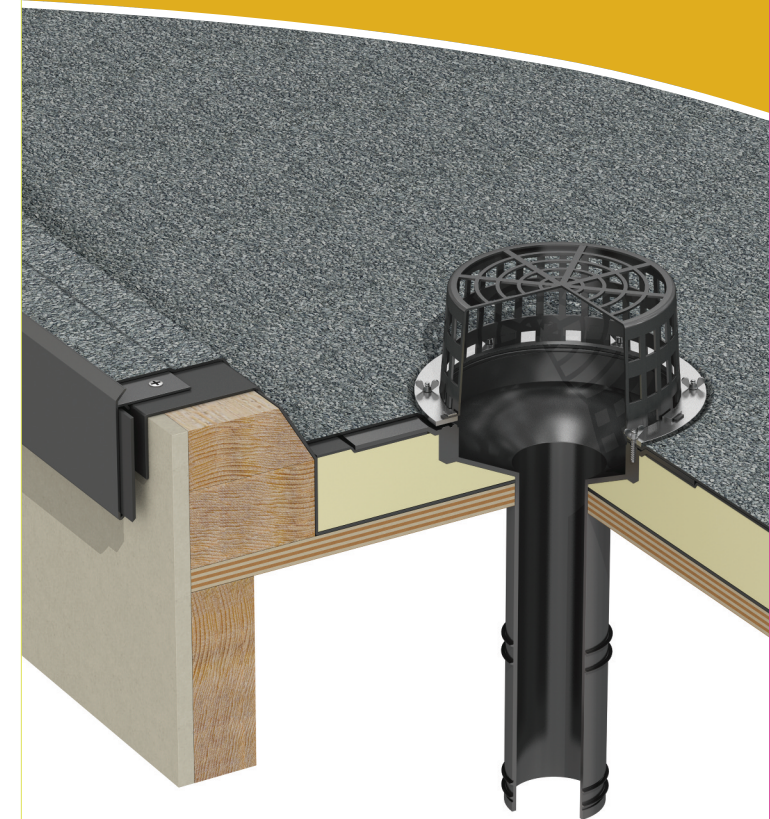

 **em-trim® & accessories**
for flat roofs