

BENCHES

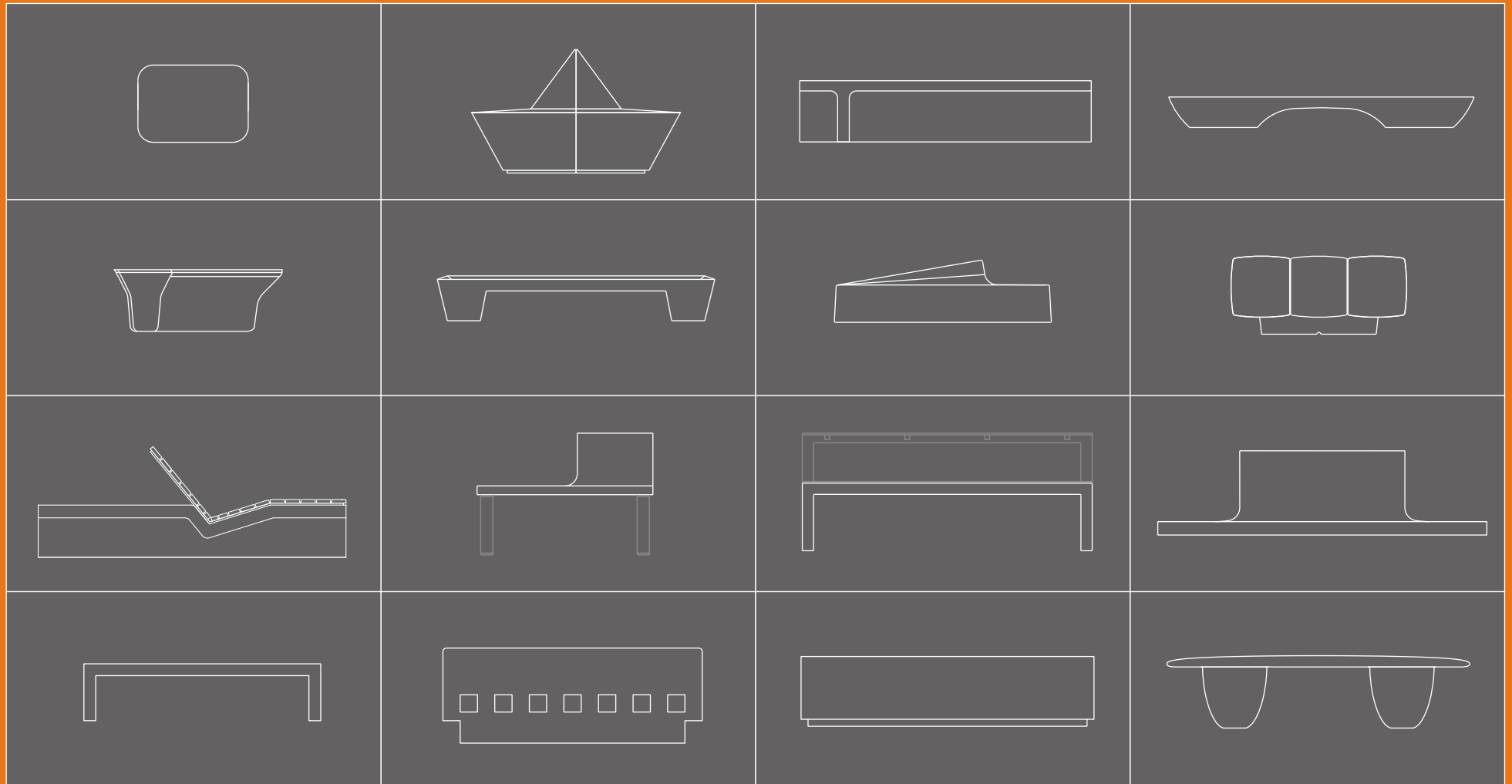



Designer: Lucile Souflet (BE)

SPECIFICATIONS

MATERIAL	Cast stone Class 1 FSC Exotic wood - Electro-polished stainless steel 316L
FIXING	4x M12 Shelve - length 200mm for Ville 1 Free standing, partly buried for Ville 2, Soleil, Vent



GEOMETRY

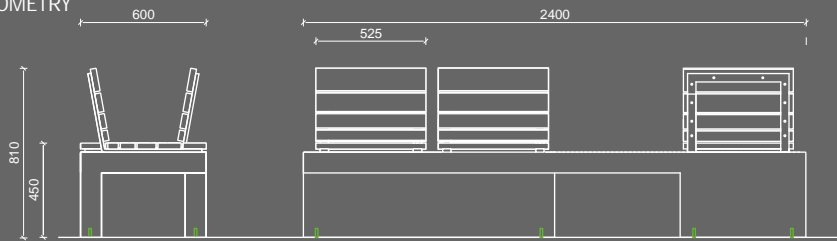

VILLE 1

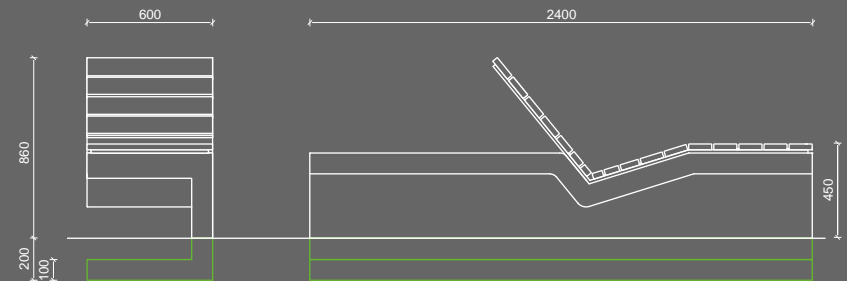

SOLEIL

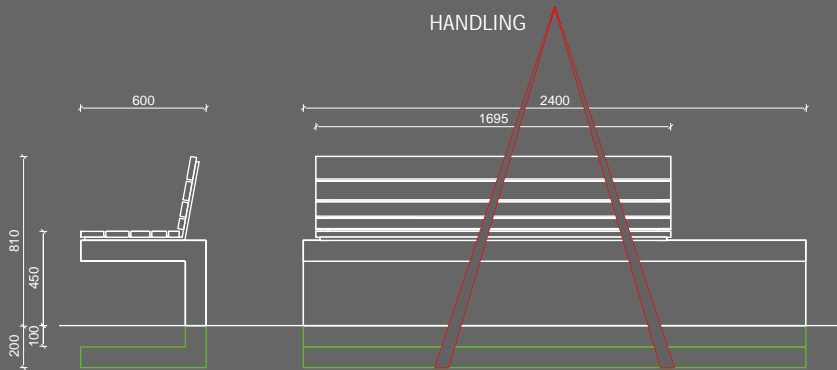

VILLE 2

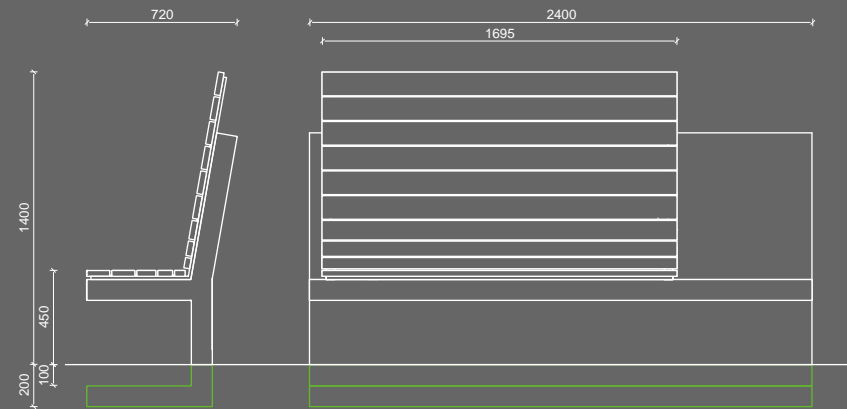

VENT



Appropriate seat height. Backrest is available for support. Easy to stand-up thanks to free room under the seating.

SPECIFICATIONS

WEIGHT Ville 1: 456 kgs Ville 2: 912 kgs
 Soleil: 916 kgs Vent: 1296 kgs

FINISHES Fair faced / Micro etched / Polished / Velvet
 Waterproof and anti-graffiti protection

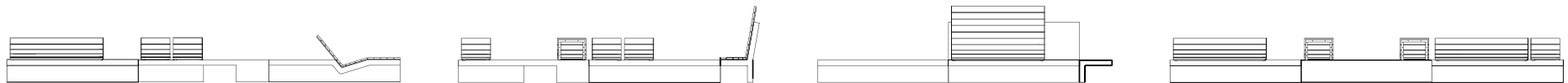

Bench Touquet



Designers: De Ferm - Vanderhenst (BE)

SPECIFICATIONS

MATERIAL	Cast stone Class 1 PEFC European Robinia
FIXING	4x M12 Shelve - length 200mm Free-standing
FINISHES	Micro etched / Polished / Velvet Waterproof and anti-graffiti protection



GEOMETRY

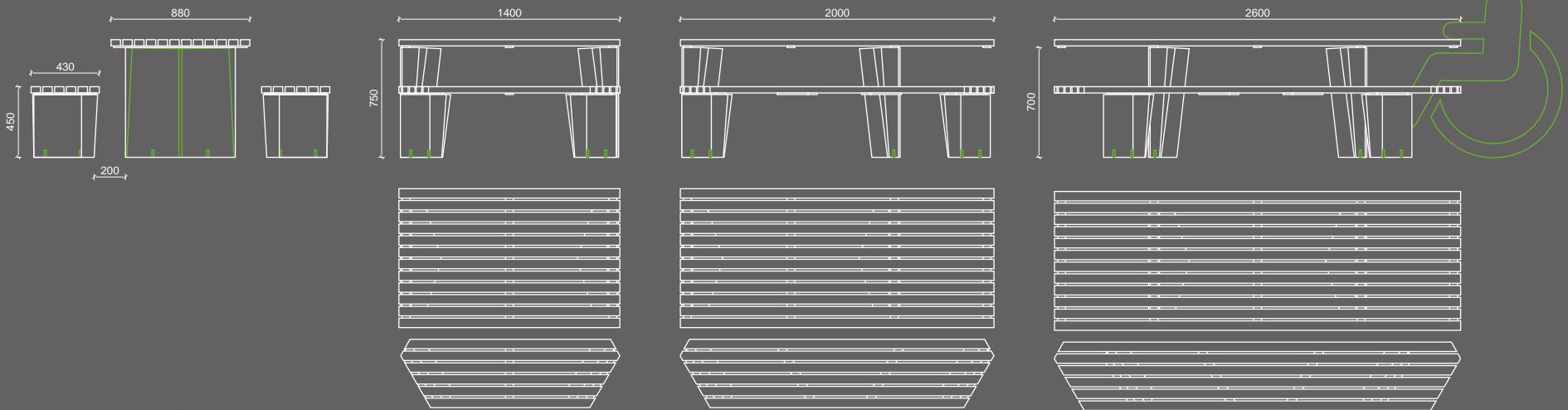

HANDLING

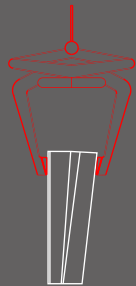

People in wheelchair welcome at table.
Perimeter is easily noticeable with white cane.
Appropriate seat and table height. Easy to stand-up thanks to free room under the seating.





Designers: Crous Calogero (ES)

SPECIFICATIONS

MATERIAL	Cast stone
FIXING	Free-standing
WEIGHT	624 kg
FINISHES	Micro etched / Polished / Velvet
	Waterproof and anti-graffiti protection



Bench Paperboat

GEOMETRY

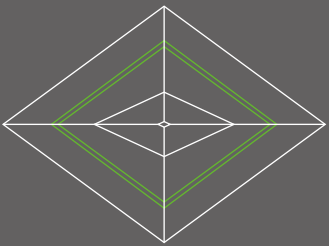
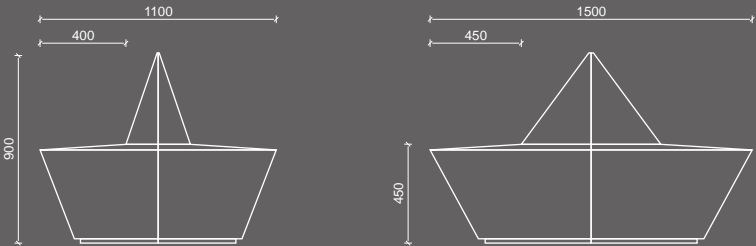

HANDLING

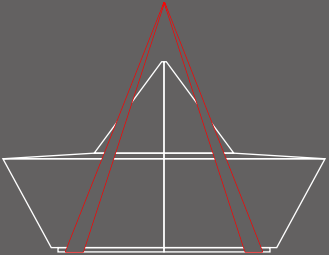

Perimeter is easily noticeable with white cane.
Appropriate seat height. Easy to stand-up thanks to back slope under seating.
Volume is easily understandable and friendly for people with cognitive disabilities.





Designers:
Karen Schou Andersen & Hans Christian Asmussen (DK)

SPECIFICATIONS

MATERIAL	Cast stone
FIXING	Free standing
WEIGHT	290 kg
FINISHES	Micro etched / Polished / Velvet
	Waterproof and anti-graffiti protection



GEOMETRY

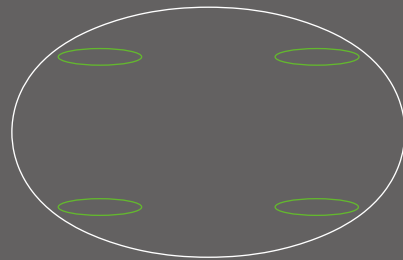
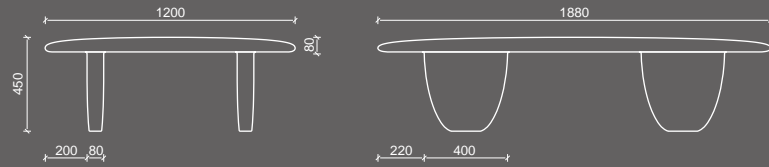

HANDLING

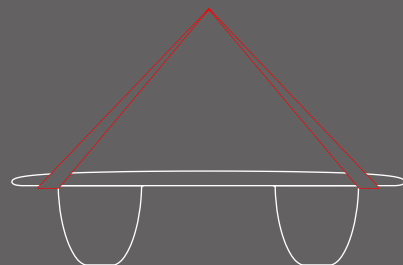

Perimeter is easily noticeable with white cane.
Appropriate seat height. Easy to stand-up thanks to free room under seating.
Volume is easily understandable and friendly for people with cognitive disabilities.





SPECIFICATIONS

MATERIAL	Cast stone
FIXING	Free-standing
WEIGHT	1.416 kg
FINISHES	Micro etched / Polished / Velvet Waterproof and anti-graffiti protection

GEOMETRY

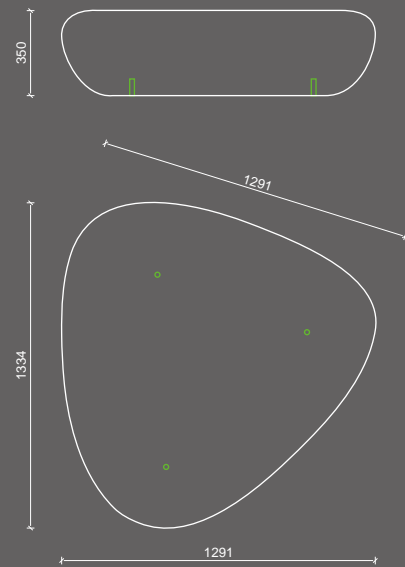

HANDLING

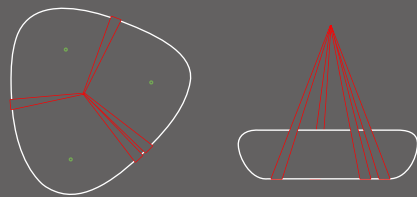

Perimeter is easily noticeable with white cane.
Volume is easily understandable and friendly for people with cognitive disabilities.





SPECIFICATIONS

MATERIALS	Cast stone Stainless steel armrest
FIXING	4x M12 Shelve - Length 200 mm
WEIGHT	Small : 753 kg - Long : 1.936 kg
FINISHES	Fair faced / Micro etched / Polished / Velvet Waterproof and anti-graffiti protection



GEOMETRY

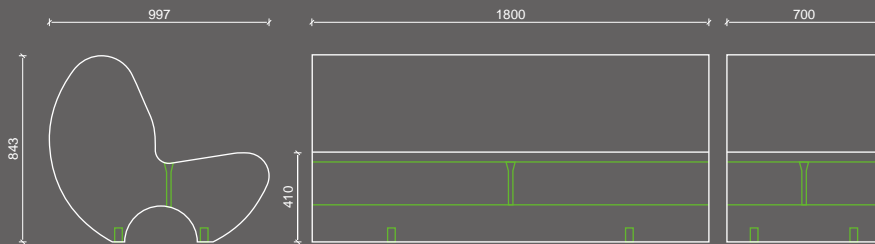

HANDLING

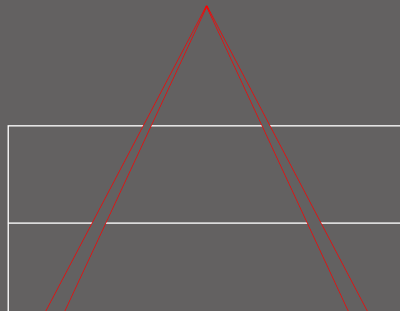

Perimeter is easily noticeable with white cane.
Backrest is present and armrest is available for support and standing-up. Easy to stand-up also thanks to back slope under seating.
Volume is easily understandable and friendly for people with cognitive disabilities.





SPECIFICATIONS

MATERIALS	Cast stone Stainless steel armrests
FIXING WEIGHT	Free standing 2.416 kg
FINISHES	Fair faced / Micro etched / Polished / Velvet Waterproof and anti-graffiti protection



GEOMETRY

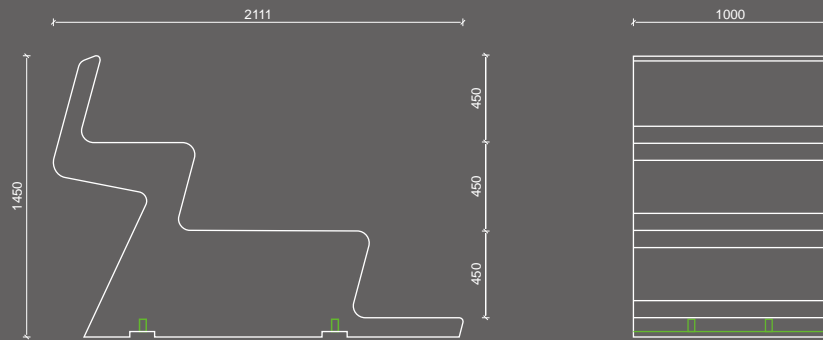

HANDLING

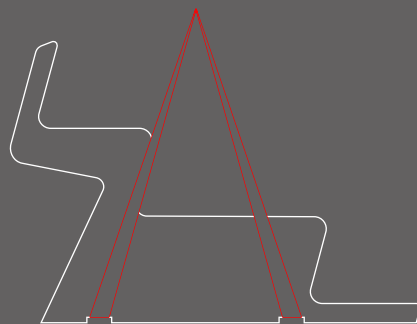

Perimeter is easily noticeable with white cane.
 Appropriate seat height. Backrest is present and armrest is available for support and standing up.
 Easy to stand-up thanks to back slope under seating. Volume is easily understandable and friendly for people with cognitive disabilities.





SPECIFICATIONS

MATERIAL	Cast stone
FIXING	Free-standing
WEIGHT	See plans
FINISHES	Fair faced / Micro etched / Polished / Velvet Waterproof and anti-graffiti protection



GEOMETRY

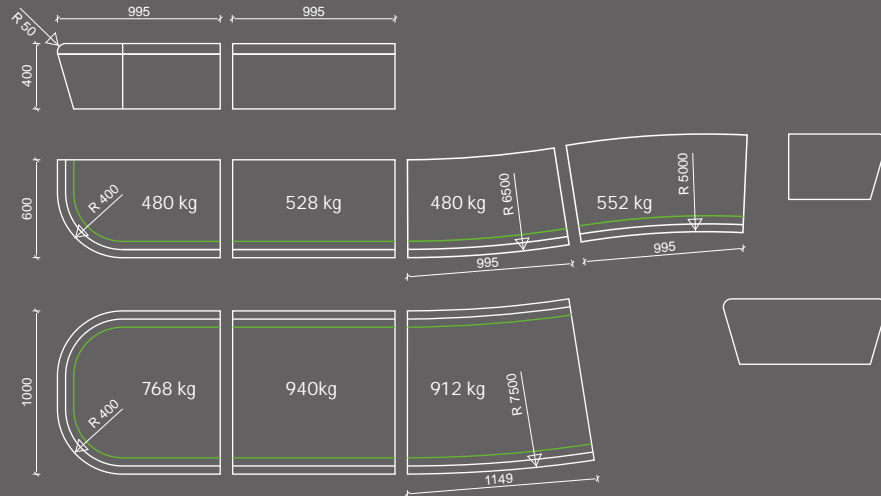

HANDLING

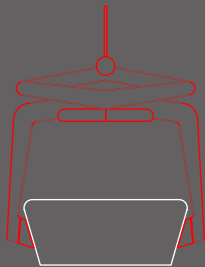

Perimeter is easily noticeable with white cane.
 Appropriate seat height with optional relaxing backrest. Easy to stand-up thanks to back slope under seating.
 Volume is easily understandable and friendly for people with cognitive disabilities.





SPECIFICATIONS

MATERIAL Cast stone
 FIXING Free-standing
 WEIGHT See table

FINISHES Fair faced / Micro etched / Polished / Velvet
 Waterproof and anti-graffiti protection

GEOMETRY

Side view

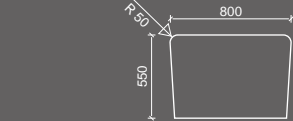

Front view

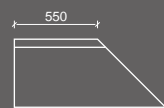
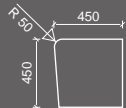
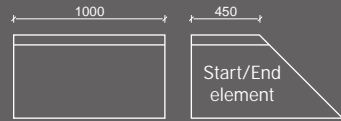

Top view

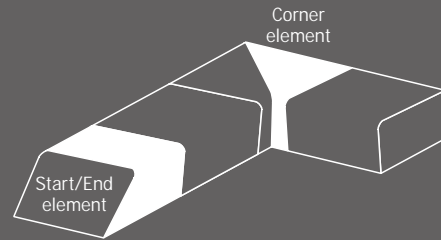
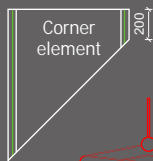
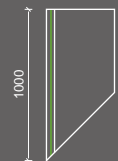
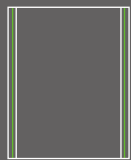
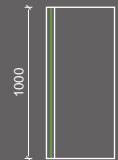

HANDLING

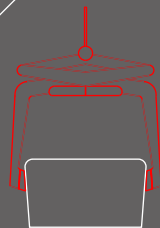

STRAIGHT

One sloped side: 45x45x100 cm - 468 kg
 Two sloped sides: 80x45x100 cm - 816 kg
 80x55x100 cm - 1008 kg

CORNER

One sloped side: 45x45x100 cm - 362 kg
 Two sloped sides: 80x45x100 cm - 490 kg
 80x55x100 cm - 604 kg

START/END

One sloped side: 45x45x100 cm - 358 kg
 Two sloped sides: 80x45x100 cm - 632 kg
 80x55x100 cm - 730 kg



Bench Millennium



Perimeter is easily noticeable with white cane.
 Appropriate seat height. Easy to stand-up thanks to back slope under seating.
 Volume is easily understandable and friendly for people with cognitive disabilities.





Designer: Manon de Smet (BE)

SPECIFICATIONS

MATERIAL	UHPC
FIXING	4x M10 Shelve - length 120 mm
WEIGHT	Table: 280 kg
FINISHES	Fair faced Waterproof and anti-graffiti protection

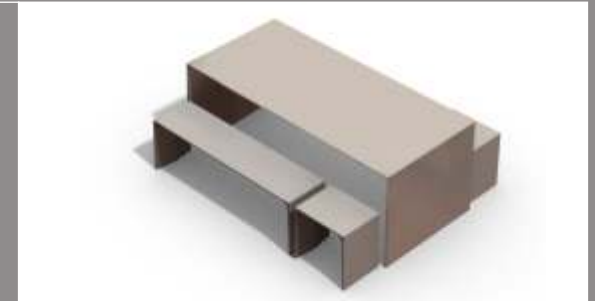

GEOMETRY

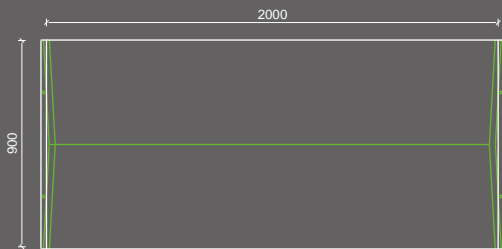
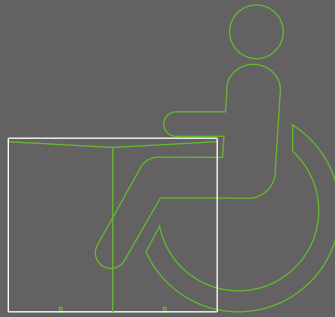

HANDLING

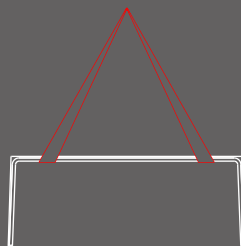

Appropriate table height.
People in wheelchair welcome at table.

Combination tip: Table p. 32, Seat p. 100



Designer: Manon de Smet (BE)

SPECIFICATIONS

MATERIAL	UHPC
FIXING	4x M6 Shelve - length 120 mm
WEIGHT	Bench: 65/80 kg Seat: 28 kg
FINISHES	Fair faced Waterproof and anti-graffiti protection

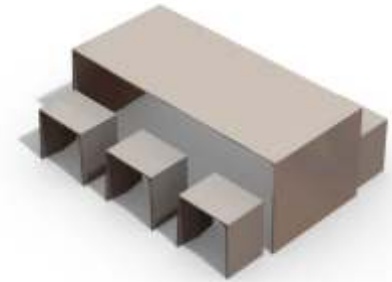

GEOMETRY

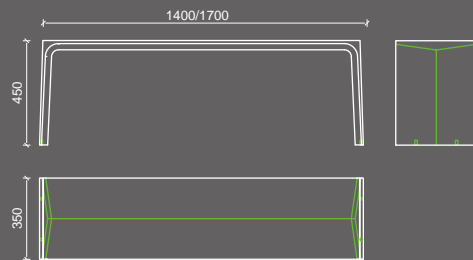

HANDLING

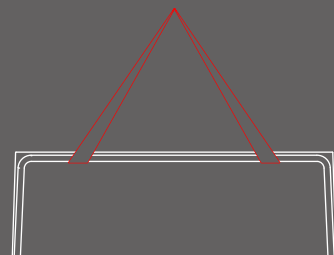

Bench Line & Line



Appropriate seat height. Easy to stand-up thanks to free room under seating.





Designer: Marine Peyre (FR)

SPECIFICATIONS

MATERIAL	Cast stone
FIXING	2x M12 Shelve - length 200mm
WEIGHT	see table
FINISHES	Micro etched / Polished / Velvet Waterproof and anti-graffiti protection



GEOMETRY

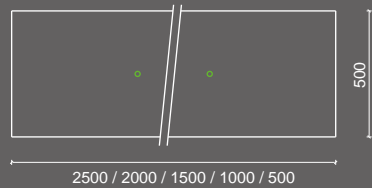

Top view

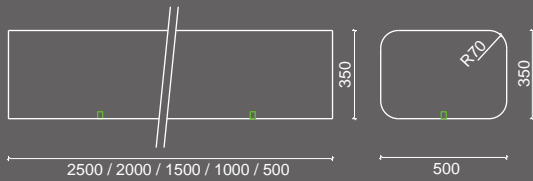

Front view

Side view

HANDLING

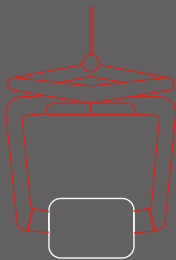

Benches

- Type 1 - 250/50/35 cm - 1.094 kg
- Type 2 - 200/50/35 cm - 875 kg
- Type 3 - 150/50/35 cm - 657 kg
- Type 4 - 100/50/35 cm - 440 kg
- Type 5 - 50/50/35 cm - 220 kg



Perimeter is easily noticeable with white cane.
Stacking two elements creates a backrest.
Volume is easily understandable and friendly for people with cognitive disabilities.



Designer: Marine Peyre (FR)

SPECIFICATIONS

MATERIAL	Cast stone
FIXING	2x M12 Shelve - length 200mm
WEIGHT	see table
FINISHES	Micro etched / Polished / Velvet Waterproof and anti-graffiti protection



GEOMETRY

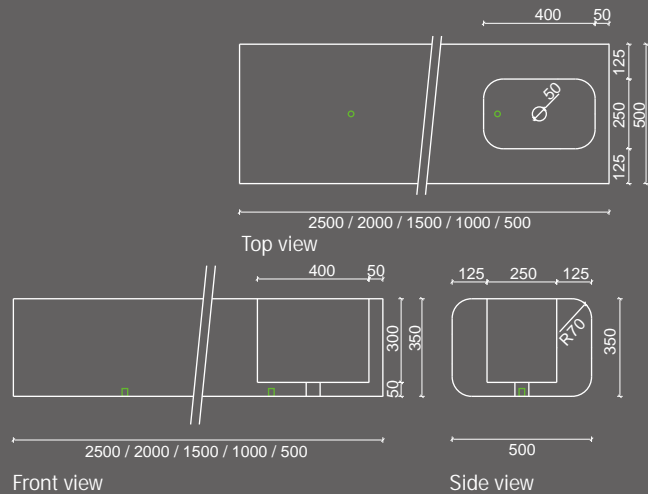

HANDLING

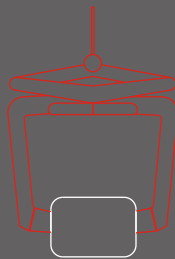

Perimeter is easily noticeable with white cane.
Stacking two elements creates a backrest.
Volume is easily understandable and friendly for people with cognitive disabilities.

Bench with planter 40/25/30 cm
Type 1.1 - 250/50/35 cm - 1.019 kg
Type 2.4 - 200/50/35 cm - 775 kg
Type 3.2 - 150/50/35 cm - 581 kg

Bench with planter 40/10/30 cm
Type 1.3 - 250/50/35 cm - 1.064 kg
Type 2.3 - 200/50/35 cm - 820 kg
Type 3.1 - 150/50/35 cm - 627 kg

Bench with planter 12,5/25/30 cm
Type 1.2 - 250/50/35 cm - 1.070 kg
Type 2.1 - 200/50/35 cm - 828 kg
Type 3.3 - 150/50/35 cm - 635 kg

Bench with long planter 10/30 cm
Type 1.4 - 250/50/35 cm - 989 kg
Type 2.2 - 200/50/35 cm - 770 kg
Type 3.4 - 150/50/35 cm - 552 kg
Type 4.1 - 100/50/35 cm - 335 kg





Designer: Arne Quinze (BE)

SPECIFICATIONS

MATERIAL	Cast stone
FIXING	Free-standing
WEIGHT	1.450 kg
FINISHES	Micro etched Waterproof and anti-graffiti protection Structured



GEOMETRY

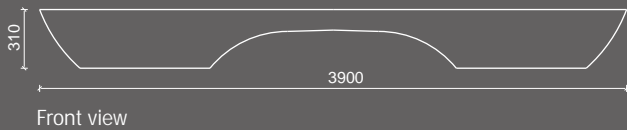
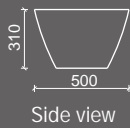
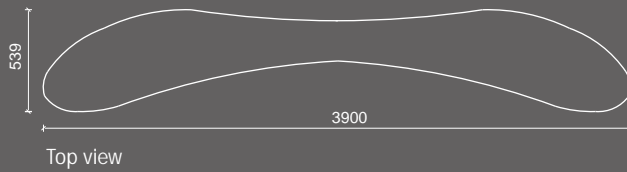

HANDLING

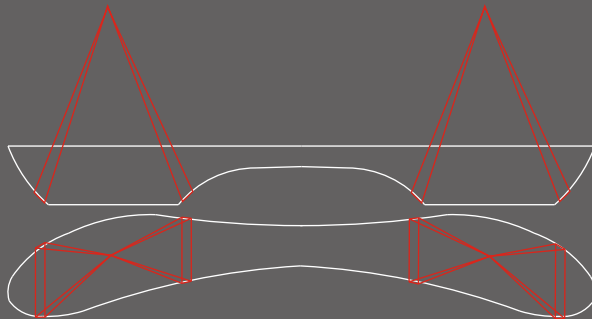

Perimeter is easily noticeable with white cane.
Volume is easily understandable and friendly for people with cognitive disabilities.



Designer: Alain Gilles (BE)

SPECIFICATIONS

MATERIAL	Cast stone
FIXING	Free-standing
WEIGHT	800 kg
FINISHES	Micro etched / Polished / Velvet Waterproof and anti-graffiti protection



GEOMETRY

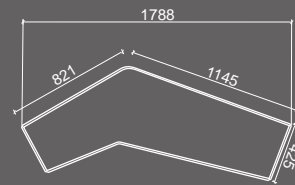

Top view

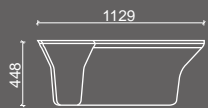

Side view

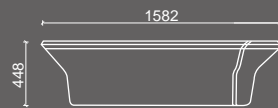

Front view

HANDLING

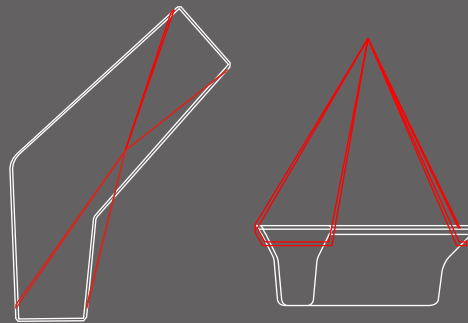

Perimeter is easily noticeable with white cane.
Appropriate seat height. Easy to stand-up thanks to back slope under seating.
Volume is easily understandable and friendly for people with cognitive disabilities.





Designer: Roel Vandebeek (BE)

SPECIFICATIONS

MATERIAL	Cast stone Lacquered steel
FIXING	Free-standing
WEIGHT	460 kg
FINISHES	Micro etched / Polished / Velvet Waterproof and anti-graffiti protection



GEOMETRY

Front view



Side view

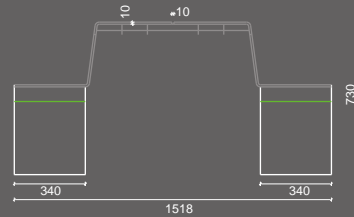

HANDLING
of the benches

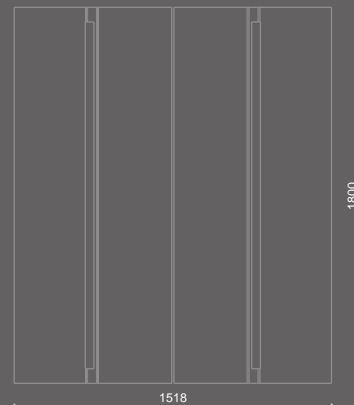
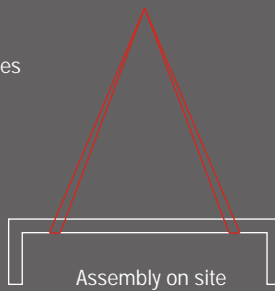

Top view



People in wheelchair welcome at table. Perimeter is easily noticeable with white cane.
Possibility to use table as backrest when sitting. Easy to stand-up thanks to free room under seating.
Volume is easily understandable and friendly for people with cognitive disabilities.



Designer: Studio Segers (BE)

SPECIFICATIONS

MATERIAL	UHPC Galvanized steel
FIXING	4x M10 Shelve
WEIGHT	140 kg
FINISHES	Fair faced Waterproof and anti-graffiti protection



Bench 1 m²

GEOMETRY

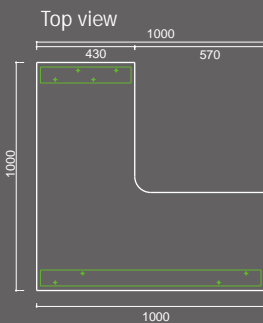
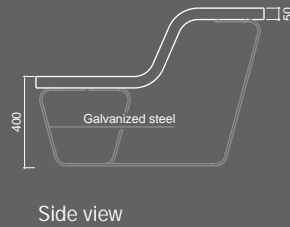
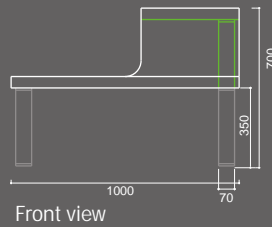

HANDLING

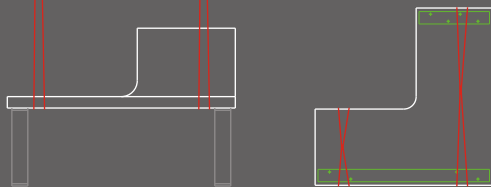

Backrest integrated. Easy to stand-up thanks to back slope under seating. People in wheelchair welcome at table.





Designer: Lucile Souflet (BE)

SPECIFICATIONS

MATERIAL	Cast stone
FIXING	2x M12 Shelve/element
WEIGHT	5.280 kg
FINISHES	Micro etched / Polished / Velvet Waterproof and anti-graffiti protection



GEOMETRY

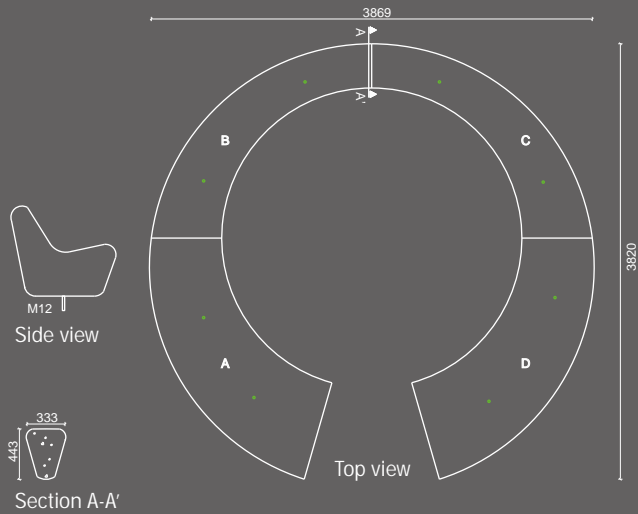

HANDLING

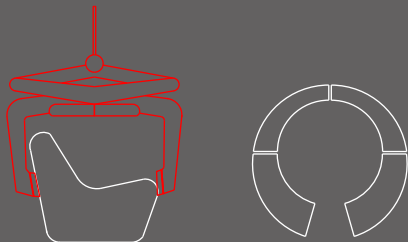

Perimeter is easily noticeable with white cane.
 Appropriate seat height. Backrest integrated for support. Easy to stand-up thanks to back slope under seating.
 Volume is easily understandable and friendly for people with cognitive disabilities.



Designer: Roel Vandebek (BE)

SPECIFICATIONS

MATERIAL	Cast stone
FIXING	Incorporated
WEIGHT	790 kg
FINISHES	Micro etched / Polished / Velvet Waterproof and anti-graffiti protection



Bench Pop Up

GEOMETRY

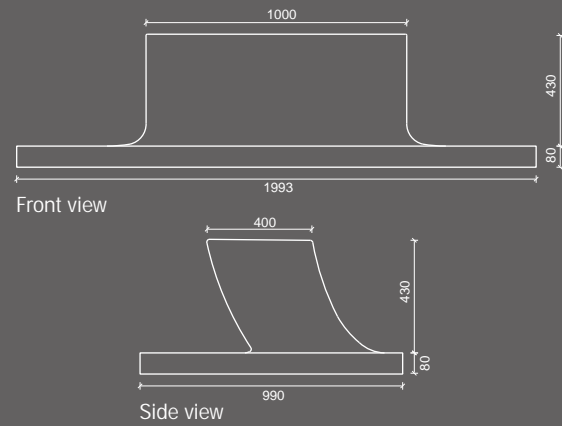

HANDLING

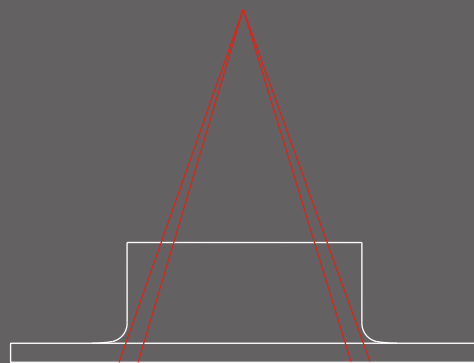

Perimeter is easily noticeable with white cane.
Appropriate seat height. Easy to stand-up thanks to back slope under seating.





Designer: Roel Vandebeek (BE)

SPECIFICATIONS

MATERIAL	Cast stone
FIXING	Free-standing
WEIGHT	800 kg
FINISHES	Micro etched Waterproof and anti-graffiti protection



GEOMETRY

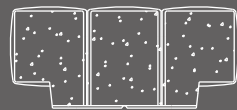

Crosscut

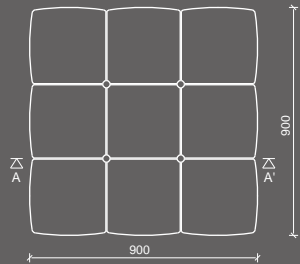

Top view

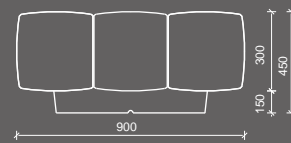

Side view / Front view

HANDLING

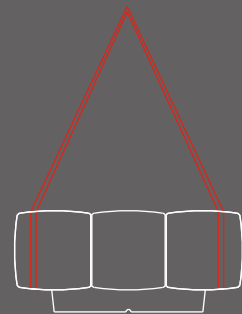
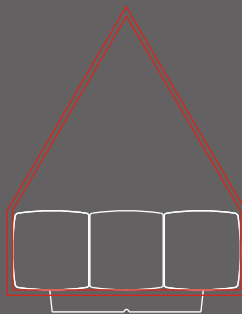

Perimeter is easily noticeable with white cane.
Volume is easily understandable and friendly for people with cognitive disabilities.



Designer: Roel Vandebeek (BE)

SPECIFICATIONS

MATERIAL	Cast stone
FIXING	Free-standing
WEIGHT	5.400 kg
FINISHES	
	Micro etched / Polished / Velvet
	Waterproof and anti-graffiti protection



Bench Round 2

GEOMETRY

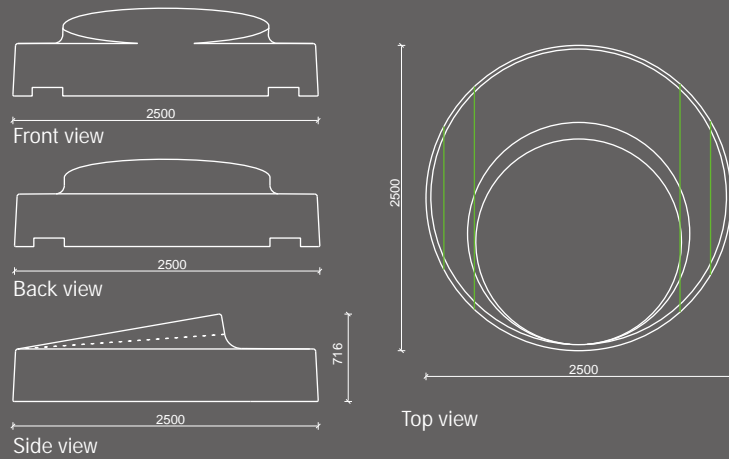

HANDLING



Perimeter is easily noticeable with white cane.
Volume is easily understandable and friendly for people with cognitive disabilities.





Designer: Roel Vandebeek (BE)

SPECIFICATIONS

MATERIAL	Cast stone
FIXING	2x M12 Shelfe
WEIGHT	907 kg
FINISHES	Micro etched / Polished / Velvet
	Waterproof and anti-graffiti protection



GEOMETRY

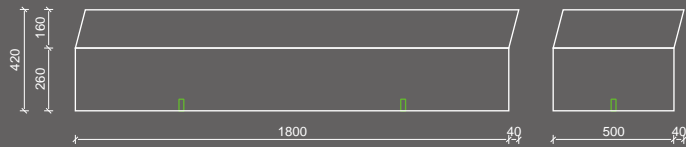

Front view

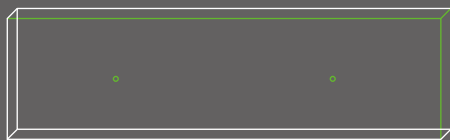

Top view

HANDLING

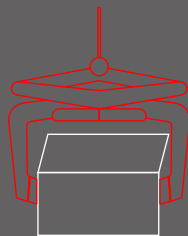

Perimeter is easily noticeable with white cane.
Volume is easily understandable and friendly for people with cognitive disabilities.



Designer: Peter Van Riet (BE)

SPECIFICATIONS

MATERIAL	Cast stone
FIXING	Free-standing
WEIGHT	1.870 kg
FINISHES	Micro etched / Polished / Velvet
	Waterproof and anti-graffiti protection



Bench Block

GEOMETRY

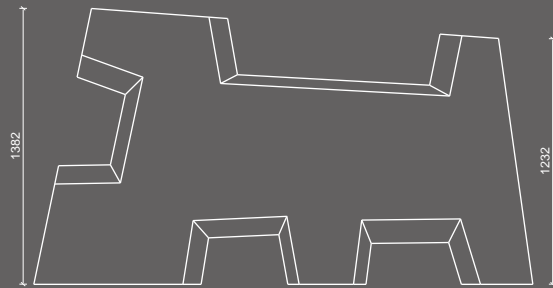
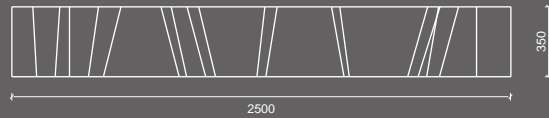

HANDLING

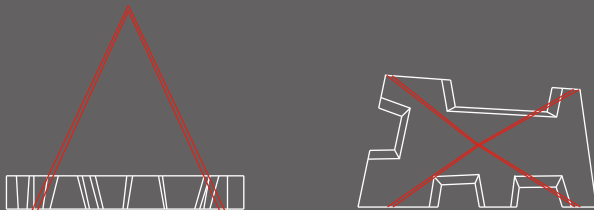

Perimeter is easily noticeable with white cane.





Designer: Benjamin Pawlica (FR)

SPECIFICATIONS

MATERIAL	Cast stone
FIXING	2x M12 Shelve - length 200 mm
WEIGHT	640 kg
FINISHES	Micro etched / Polished / Velvet Waterproof and anti-graffiti protection



GEOMETRY

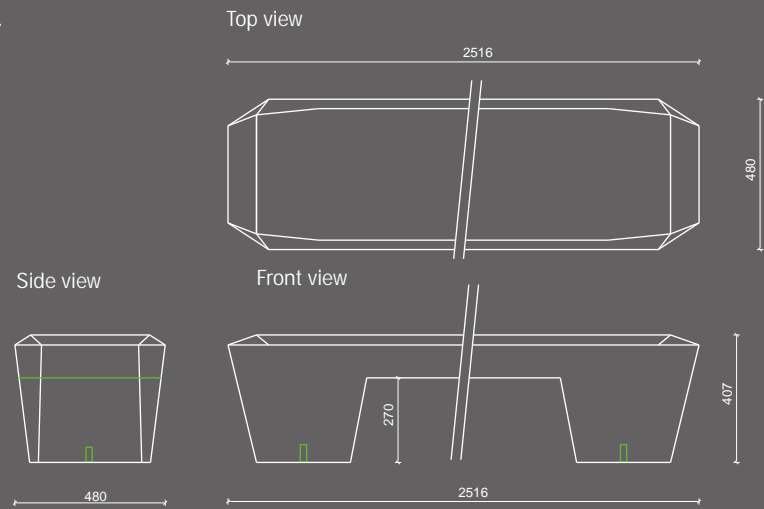

HANDLING

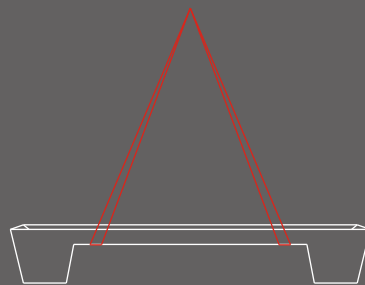

Perimeter is easily noticeable with white cane.



Designer: Benjamin Pawlica (FR)

SPECIFICATIONS

MATERIAL	Cast stone
FIXING	Free-standing
WEIGHT	700 kg
FINISHES	Micro etched / Polished / Velvet Waterproof and anti-graffiti protection



Bench Hysk

GEOMETRY

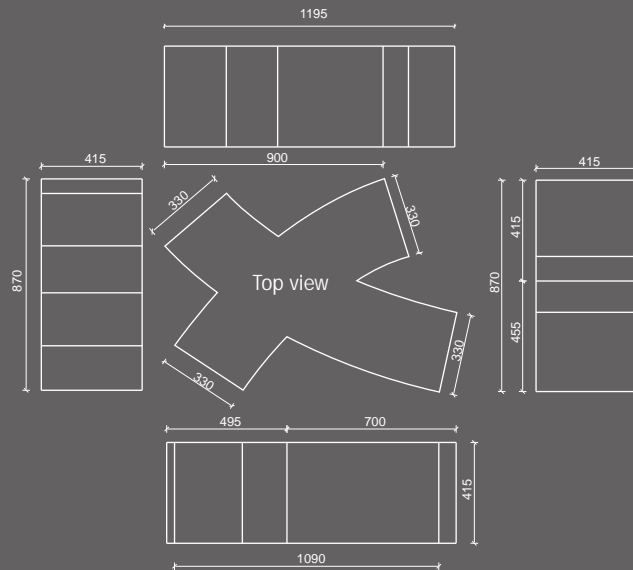

HANDLING

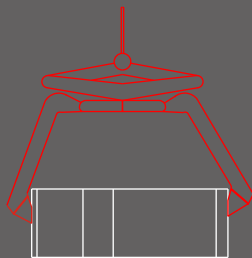

Perimeter is easily noticeable with white cane.



Designer: Frank (UK)

SPECIFICATIONS

MATERIAL	Cast stone
FIXING	4x M10 Shelve
WEIGHT	165 kg
FINISHES	Micro etched / Polished / Velvet Waterproof and anti-graffiti protection



GEOMETRY

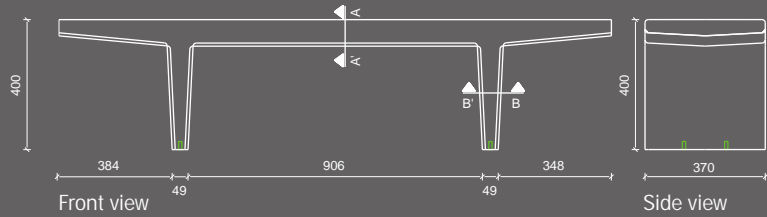

HANDLING

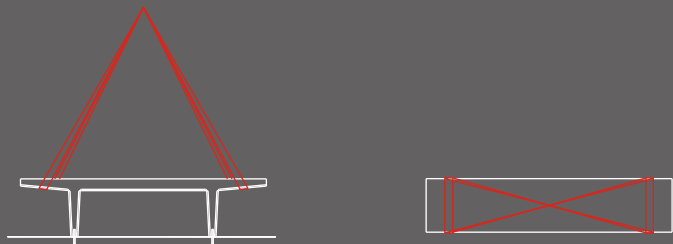



Designer: Roel Vandebeek (BE)

SPECIFICATIONS

MATERIAL	Cast stone
FIXING	2x M12 Shelfe
WEIGHT	410 kg
FINISHES	Micro etched / Polished / Velvet
	Waterproof and anti-graffiti protection



Bench Circuit

GEOMETRY

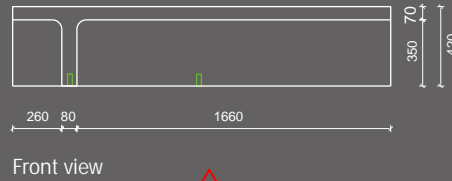
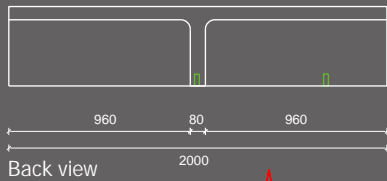
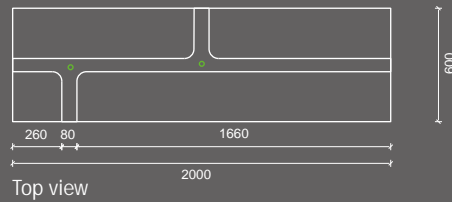
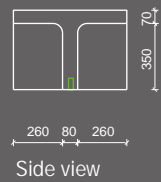

HANDLING

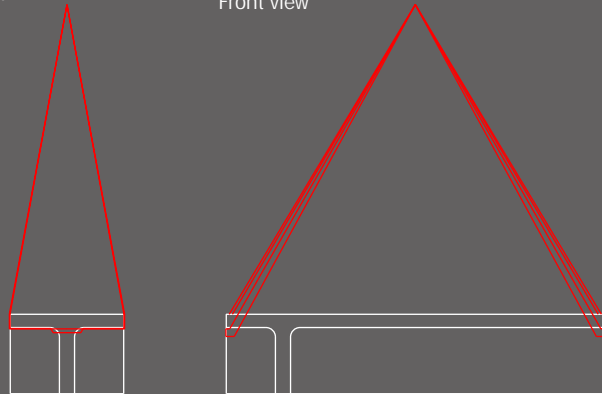

Perimeter is easily noticeable with white cane.
Appropriate seat height. Easy to stand-up thanks to free room under seating.





SPECIFICATIONS

MATERIALS	Cast stone Wood: Sapelli on stainless steel structure
FIXING WEIGHT	4x M12 Shelve - length 200 mm 1.320 kg
FINISHES	Fair faced / Micro etched / Polished / Velvet Waterproof and anti-graffiti protection

GEOMETRY

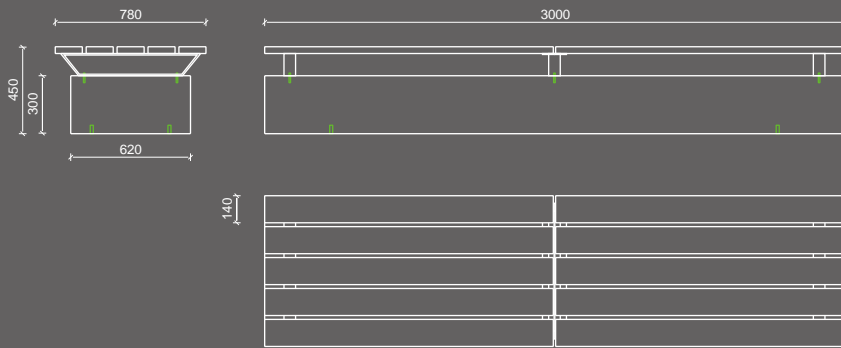

HANDLING

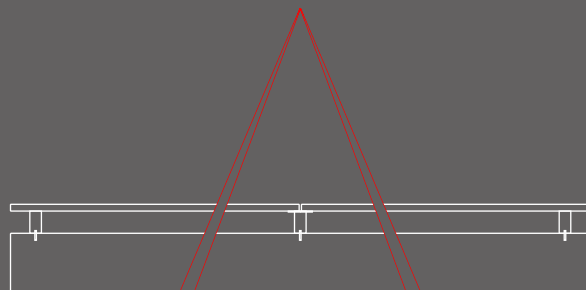

Perimeter is easily noticeable with white cane.
Appropriate seat height. Easy to stand-up thanks to free room between edge of seating and base of bench.
Volume is easily understandable and friendly for people with cognitive disabilities.



5 elements can be combined to create a planter



SPECIFICATIONS

MATERIALS	Cast stone Wood: Sapelli on stainless steel structure
FIXING	Free-standing
WEIGHT	560 kg/pc - 2.240 kg/composition
FINISHES	Micro etched / Polished / Velvet Waterproof and anti-graffiti protection

GEOMETRY

Top view with wood

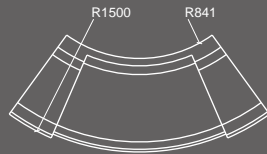

Crosscut

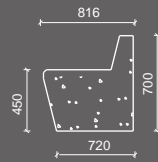

Top view without wood

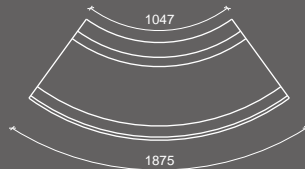

Side view



HANDLING

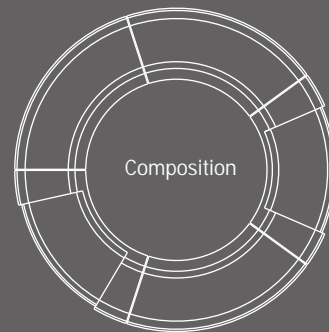
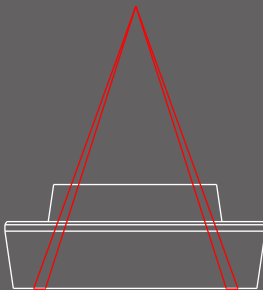

Bench WOOD-Line Round



Perimeter is easily noticeable with white cane.
Appropriate seat height. Backrest is integrated for support. Easy to stand-up thanks to back slope under seating.
Volume is easily understandable and friendly for people with cognitive disabilities.





SPECIFICATIONS

MATERIALS	Cast stone Wood: Sapelli on 50 or 100 cm stainless steel frame
FIXING	2x M12 Shelve - length 200 mm
WEIGHT	Large - 1.100 kg / Small - 308 kg
FINISHES	Micro etched / Polished / Velvet Waterproof and anti-graffiti protection



GEOMETRY

Front view

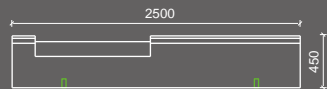

Possible Top views

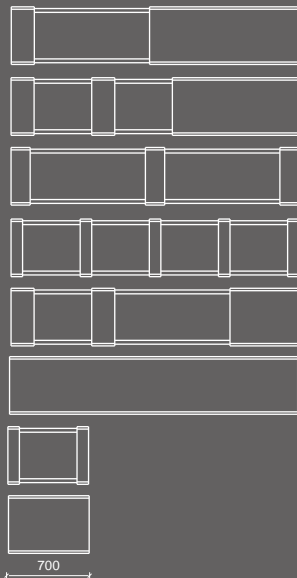

Side view

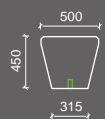

Crosscut



HANDLING

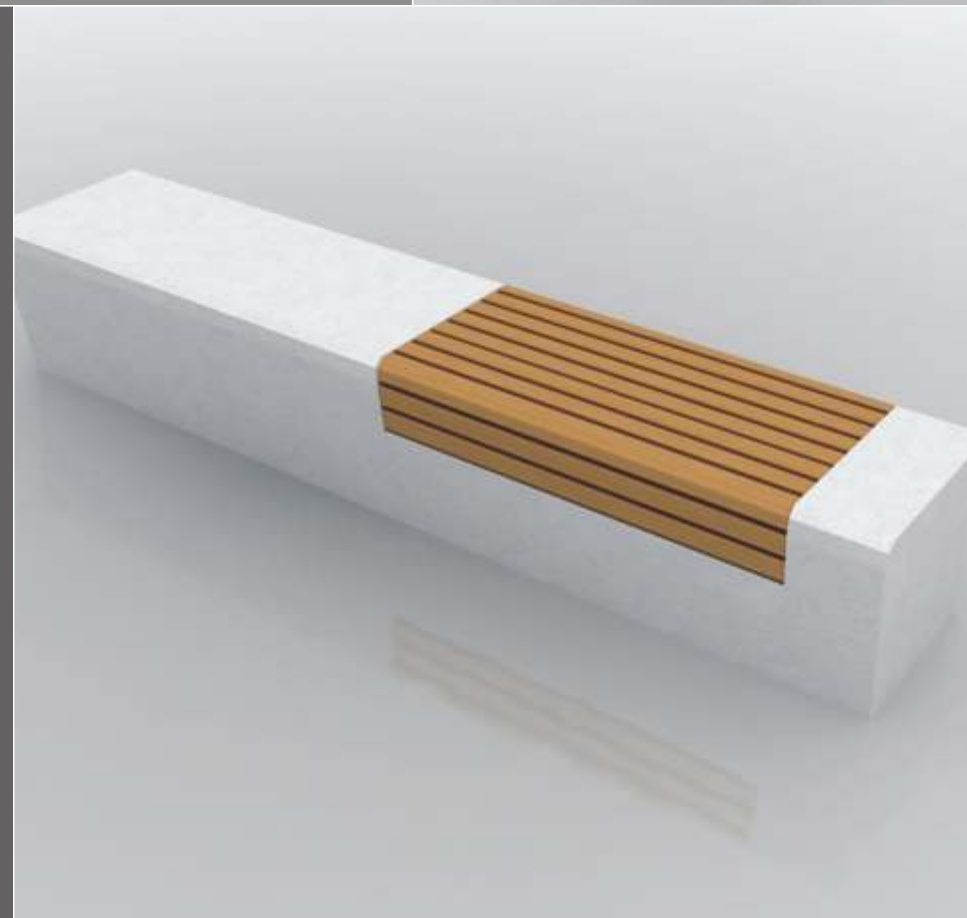
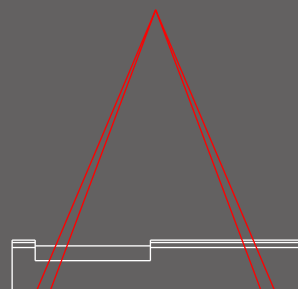

Perimeter is easily noticeable with white cane.
Appropriate seat height. Easy to stand-up thanks to back slope under seating.
Volume is easily understandable and friendly for people with cognitive disabilities.



4 elements can be combined to create a planter



SPECIFICATIONS

MATERIAL	Cast stone
FIXING	To bury partly
WEIGHT	950 kg/part - 4 parts = 3.800 kg
FINISHES	Micro etched / Polished / Velvet Waterproof and anti-graffiti protection



Bench Castricum

GEOMETRY

Top view

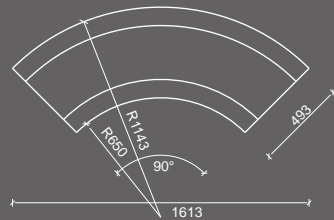

Front view



Side view

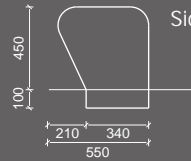

HANDLING

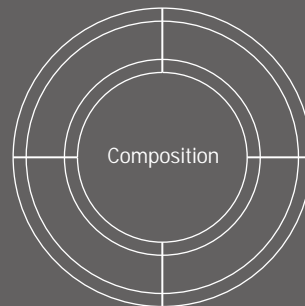
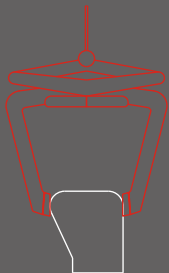

Perimeter is easily noticeable with white cane.
Appropriate seat height. Easy to stand-up thanks to back slope under seating.
Volume is easily understandable and friendly for people with cognitive disabilities.





SPECIFICATIONS

MATERIAL	Cast stone
FIXING	4x M12 Shelve - length 200 mm
WEIGHT	1.789 kg
FINISHES	Micro etched / Polished / Velvet Waterproof and anti-graffiti protection



GEOMETRY

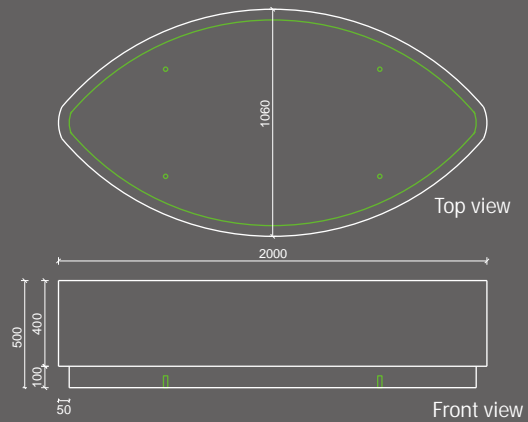

HANDLING

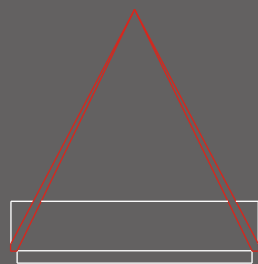

Perimeter is easily noticeable with white cane.
 Appropriate seat height for elderly people.
 Volume is easily understandable and friendly for people with cognitive disabilities.





SPECIFICATIONS

MATERIAL	Cast stone
FIXING	4x M12 Shelve - length 200mm
WEIGHT	1.620 kg
FINISHES	Micro etched / Polished / Velvet Waterproof and anti-graffiti protection



GEOMETRY

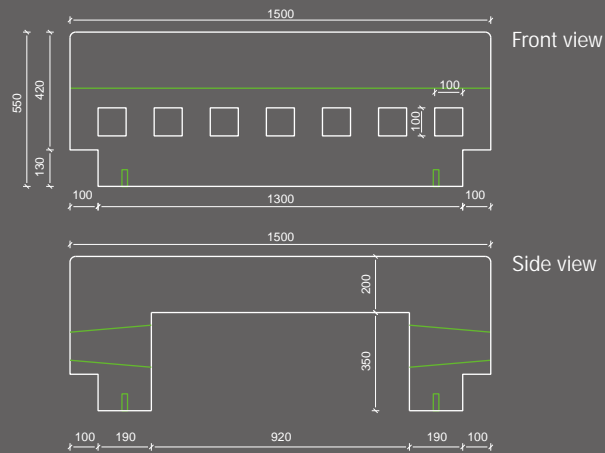

HANDLING

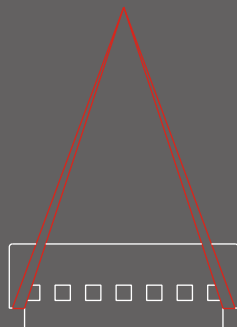

Bench Ouverture



Appropriate seat height for elderly people. Easy to stand-up thanks to free room under seating on sides. Volume is easily understandable and friendly for people with cognitive disabilities.





SPECIFICATIONS

MATERIAL	Cast stone
FIXING	To bury partly
WEIGHT	see table
FINISHES	Micro etched / Polished / Velvet Waterproof and anti-graffiti protection

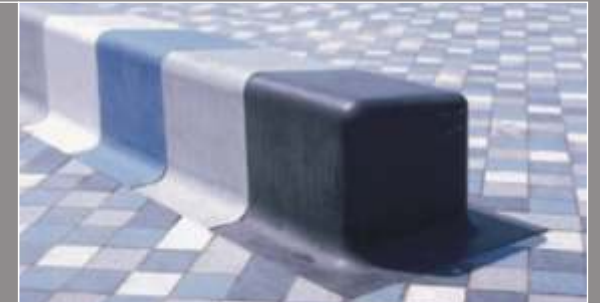

GEOMETRY

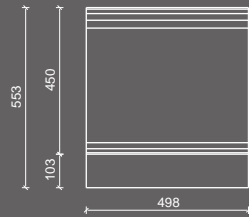

Front view

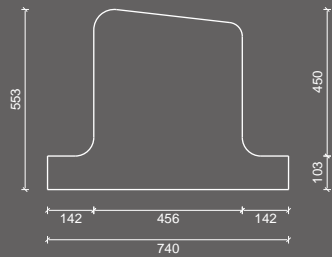

Side view

HANDLING

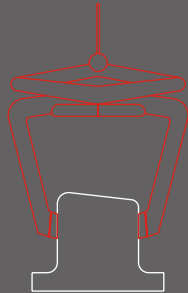

- Rubens - straight - 348 kg
- Rubens - start/end - 374 kg
- Rubens - curved - inner radius 245 cm - 387 kg



Perimeter is easily noticeable with white cane.
Volume is easily understandable and friendly for people with cognitive disabilities.





SPECIFICATIONS

MATERIAL	Cast stone
FIXING	To bury partly
WEIGHT	see plans
FINISHES	Micro etched / Polished / Velvet
	Waterproof and anti-graffiti protection



Bench Playground

GEOMETRY

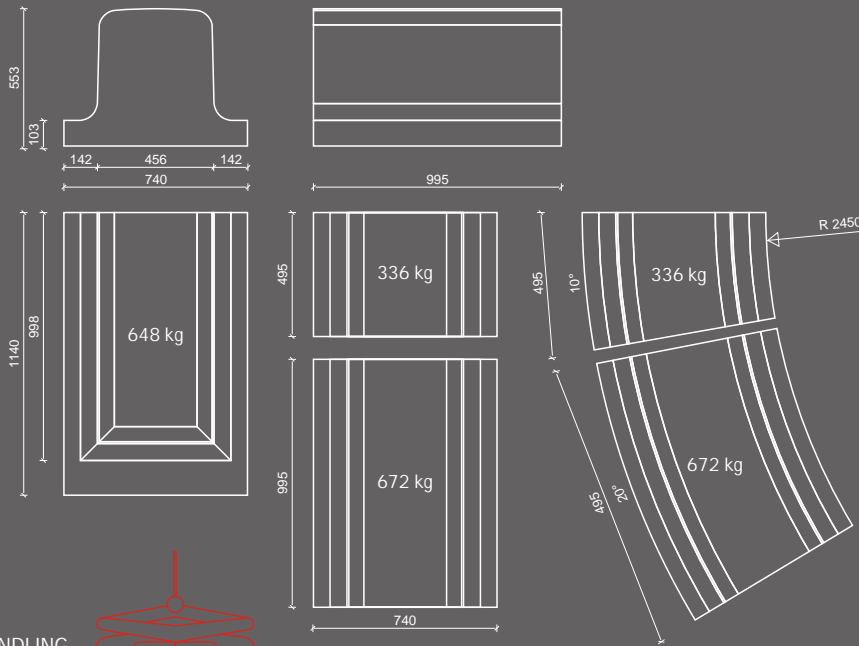

HANDLING

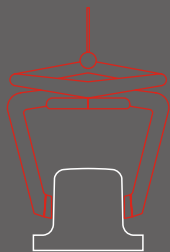

Perimeter is easily noticeable with white cane.
Volume is easily understandable and friendly for people with cognitive disabilities.





SPECIFICATIONS

MATERIAL	Cast stone
FIXING	4x M12 Shelve - length 200 mm
WEIGHT	see table
FINISHES	Micro etched / Polished / Velvet Waterproof and anti-graffiti protection

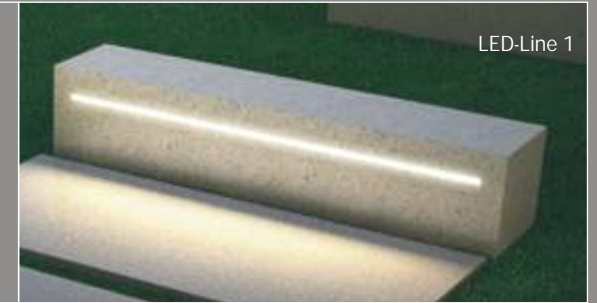

LED-Line 1

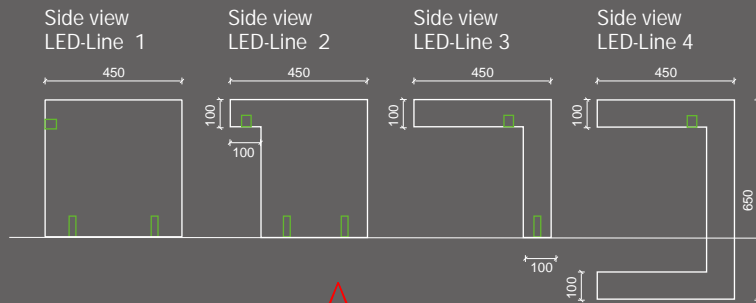
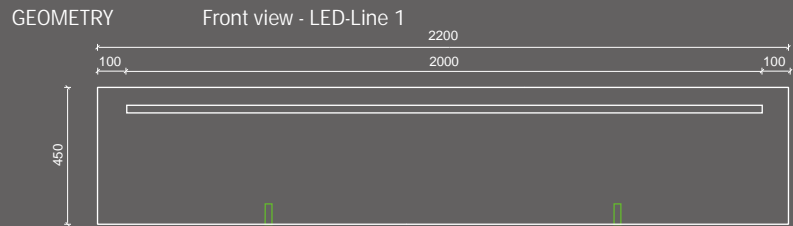

HANDLING

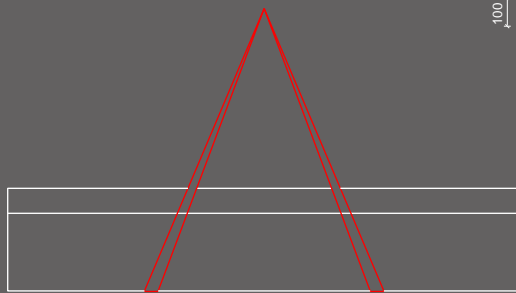

Type LED-Line 1 - 120/45/45 cm - 582 kg	Type LED-Line 1 - 220/45/45 cm - 1.070 kg
Type LED-Line 2 - 120/45/45 cm - 482 kg	Type LED-Line 2 - 220/45/45 cm - 885 kg
Type LED-Line 3 - 120/45/45 cm - 230 kg	Type LED-Line 3 - 220/45/45 cm - 425 kg
Type LED-Line 4 - 120/45/65 cm - 388 kg	Type LED-Line 4 - 220/45/65 cm - 712 kg

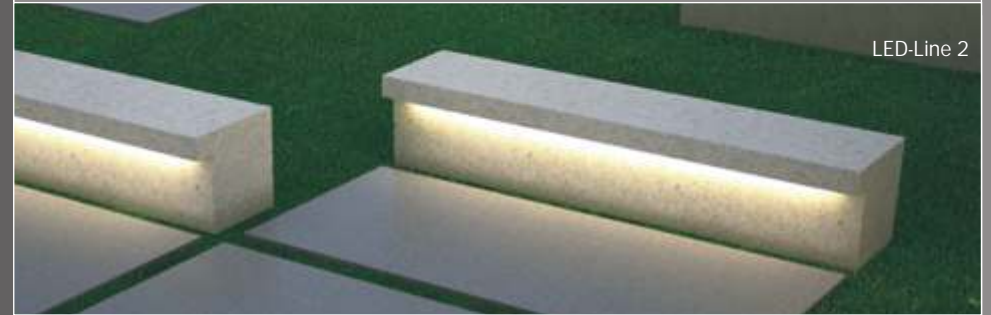

LED-Line 2



LED-Line 3 & 4



Perimeter of LED-Line 1 and LED-Line 2 is easily noticeable with white cane.
Appropriate seat height. Easy to stand-up thanks to free room under seating for LED-Line 2, LED-Line 3 and LED-Line 4.
Volume is easily understandable and friendly for people with cognitive disabilities.





SPECIFICATIONS

MATERIAL	Cast stone
FIXING	4x M12 Shelve - length 200 mm
WEIGHT	see table
FINISHES	Micro etched / Polished / Velvet Waterproof and anti-graffiti protection



GEOMETRY

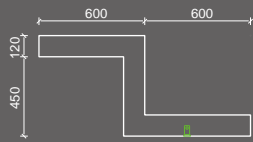

Side view

Front view

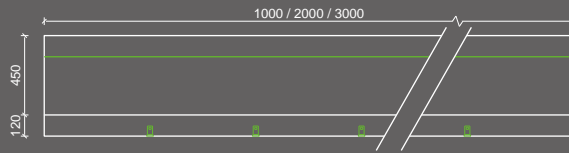

Top view



HANDLING

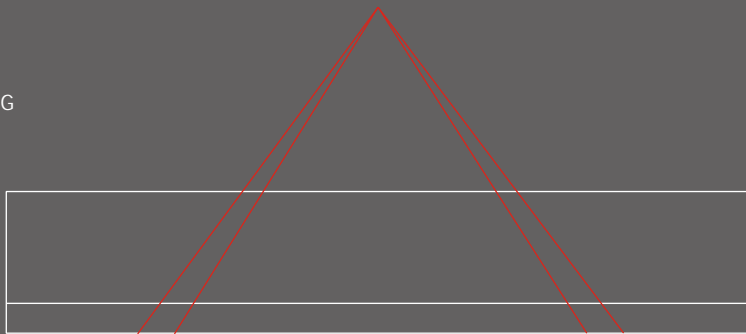

Z-Bench 300/120/45 cm - 1.426 kg

200/120/45 cm - 950 kg

100/120/45 cm - 475 kg



Z-Bench



Appropriate seat height. Easy to stand-up thanks to free room under seating (edge opposite of floor side).
Volume is easily understandable and friendly for people with cognitive disabilities.





SPECIFICATIONS

MATERIAL Cast stone
 FIXING 2x M12 Shelve - length 200 mm
 WEIGHT see table

FINISHES Fair faced / Micro etched / Polished / Velvet
 Waterproof and anti-graffiti protection



GEOMETRY

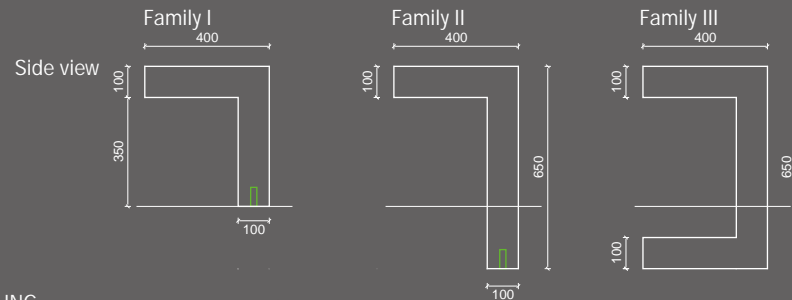
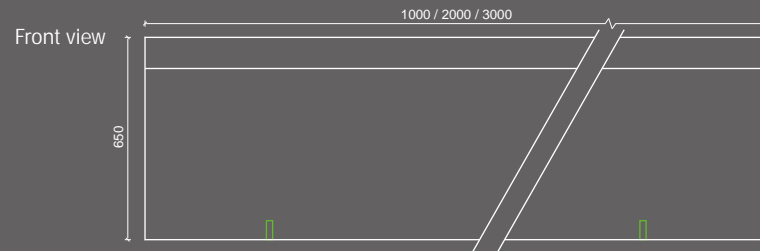

HANDLING

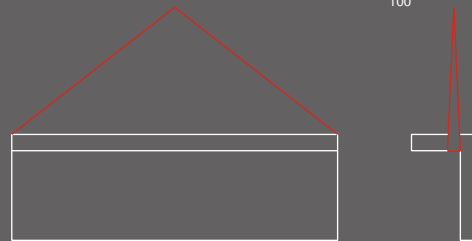

Family I	300/40/45 cm	414 kg
	200/40/45 cm	276 kg
	100/40/45 cm	138 kg

Family II	300/40/65 cm	684 kg
	200/40/65 cm	456 kg
	100/40/65 cm	228 kg

Family III	300/40/65 cm	900 kg
	200/40/65 cm	600 kg
	100/40/65 cm	300 kg



Adjustable and appropriate seat height at placement (45-55 cm). Easy to stand-up thanks to free room under seating. Volume is easily understandable and friendly for people with cognitive disabilities.





SPECIFICATIONS

MATERIAL	Cast stone
FIXING	4x M12 Shelve - length 200 mm
WEIGHT	see table
FINISHES	Fair faced / Micro etched / Polished / Velvet Waterproof and anti-graffiti protection

GEOMETRY

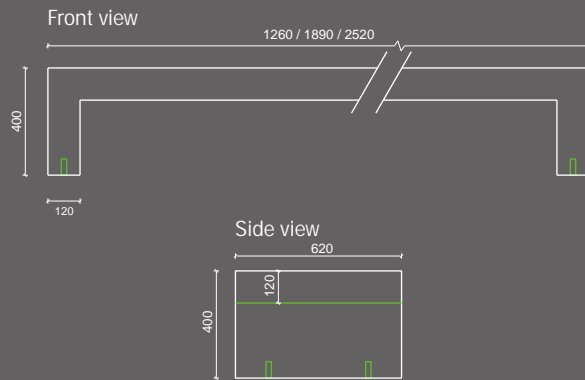

HANDLING

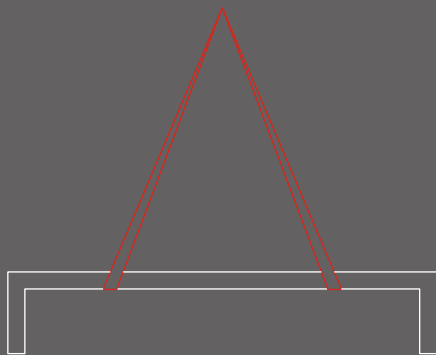

Hyjo 252/62/40 cm - 551 kg

189/62/40 cm - 437 kg

126/62/40 cm - 325 kg



Bench Hyjo



Appropriate seat height with extra feet. Easy to stand-up thanks to free room under seating. Volume is easily understandable and friendly for people with cognitive disabilities.





SPECIFICATIONS

MATERIAL UHPC
 FIXING 4x M12 or M6 Shelve - length 200 mm
 WEIGHT see table

FINISHES Fair faced / Micro etched / Polished / Velvet
 Waterproof and anti-graffiti protection



GEOMETRY

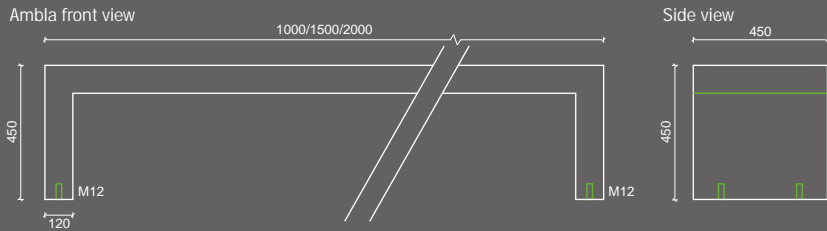

HANDLING

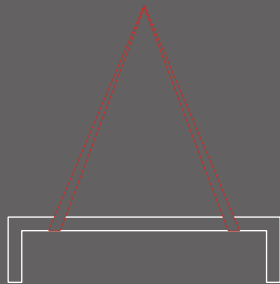

	LxWxH (cm)	Thickness (cm)	Weight (kg)
Ambla	100/45/45	12	215
	150/45/45	12	280
	200/45/45	12	344
Ambla UHPC	100/45/45	6	115
	150/45/45	6	147
	200/45/45	6	180



Appropriate seat height. Easy to stand-up thanks to free room under seating.
 Volume is easily understandable and friendly for people with cognitive disabilities.





SPECIFICATIONS

MATERIAL	Cast stone
FIXING	4x M12 Shelve - length 200 mm
WEIGHT	see table
FINISHES	Fair faced / Micro etched / Polished / Velvet Waterproof and anti-graffiti protection



GEOMETRY

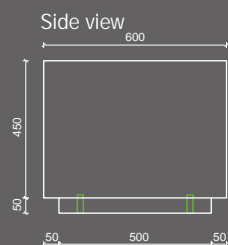
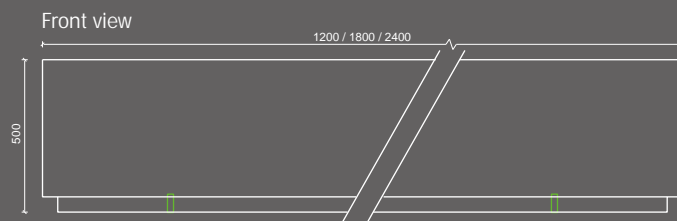

HANDLING

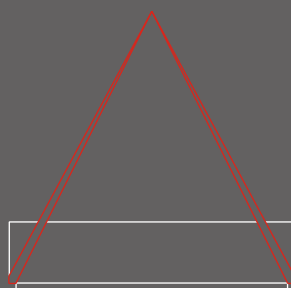

Float	240/60/50 cm - 1.690 kg
	210/60/50 cm - 1.480 kg
	180/60/50 cm - 1.265 kg
	120/60/50 cm - 845 kg



Perimeter is easily noticeable with white cane.
Volume is easily understandable and friendly for people with cognitive disabilities.





SPECIFICATIONS

MATERIAL Cast stone
 FIXING 4x M12 Shelve - length 200 mm
 WEIGHT see table
 FINISHES Fair faced / Micro etched / Polished / Velvet
 Waterproof and anti-graffiti protection



GEOMETRY

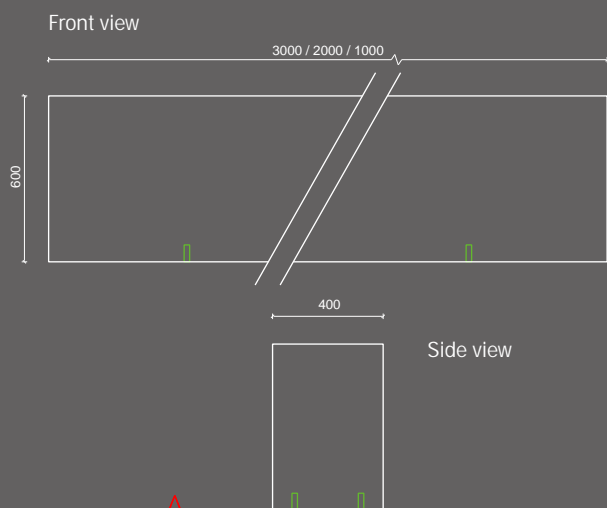

Viem 300/40/60 cm - 1.728 kg
 200/40/60 cm - 1.152 kg
 100/40/60 cm - 576 kg

HANDLING

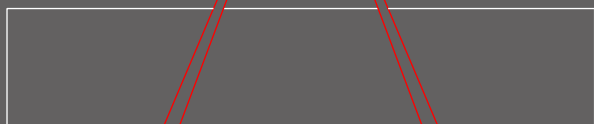

Perimeter is easily noticeable with white cane.
 Volume is easily understandable and friendly for people with cognitive disabilities.





SPECIFICATIONS

MATERIAL	Cast stone
FIXING	4x M12 Shelve - length 200 mm
WEIGHT	see table
FINISHES	Fair faced / Micro etched / Polished / Velvet Waterproof and anti-graffiti protection



GEOMETRY

Front view

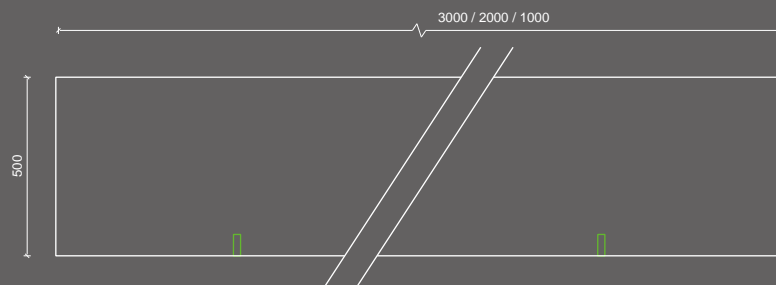

Side view

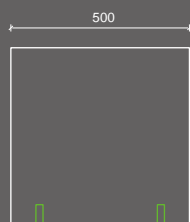

HANDLING

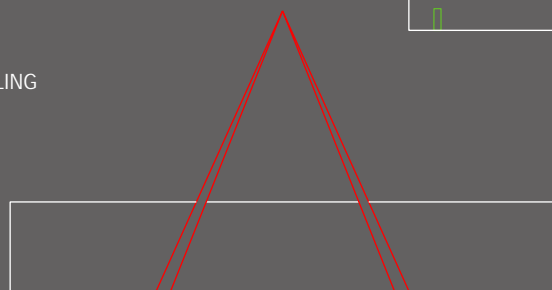

Vile 300/50/50 cm	- 1.800 kg
200/50/50 cm	- 1.200 kg
100/50/50 cm	- 600 kg



Bench Vile



Perimeter is easily noticeable with white cane.
Volume is easily understandable and friendly for people with cognitive disabilities.





SPECIFICATIONS

MATERIAL	Cast stone
FIXING	4x M12 Shelve - length 200 mm
WEIGHT	see table
FINISHES	Fair faced / Micro etched / Polished / Velvet Waterproof and anti-graffiti protection



GEOMETRY

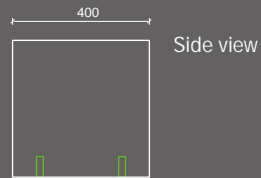
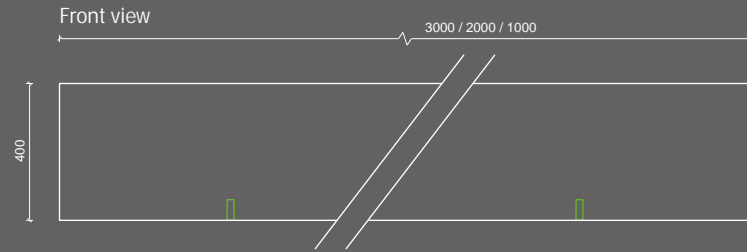

Vetil 300/40/40 cm	- 1.152 kg
200/40/40 cm	- 768 kg
100/40/40 cm	- 384 kg

HANDLING

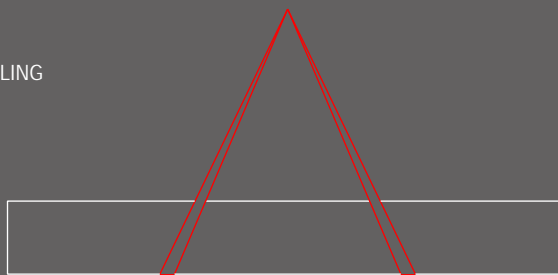

Perimeter is easily noticeable with white cane.
Volume is easily understandable and friendly for people with cognitive disabilities.





SPECIFICATIONS

MATERIAL	Cast stone
FIXING	4x M12 Shelve - length 200 mm
WEIGHT	see table
FINISHES	Fair faced / Micro etched / Polished / Velvet Waterproof and anti-graffiti protection



Bench Dome

GEOMETRY

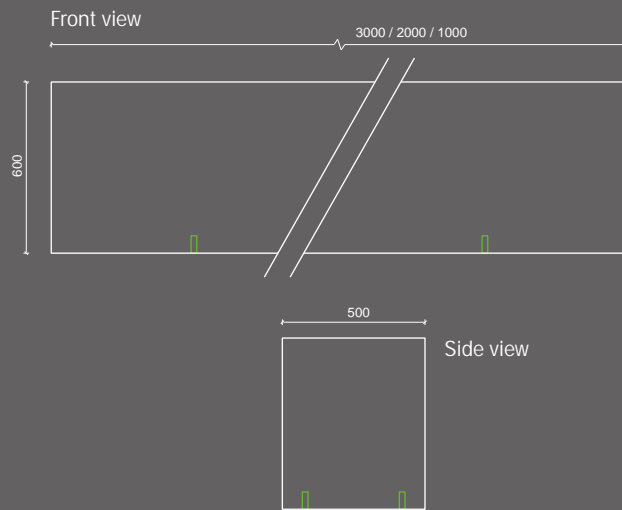

Dome 300/50/60 cm	- 2.160 kg
200/50/60 cm	- 1.440 kg
100/50/60 cm	- 720 kg

HANDLING

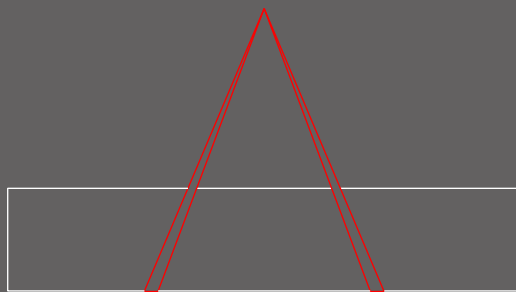

Perimeter is easily noticeable with white cane.
Volume is easily understandable and friendly for people with cognitive disabilities.





SPECIFICATIONS

MATERIAL	Cast stone
FIXING	2x M12 Shelve - length 200 mm
WEIGHT	see table
FINISHES	Fair faced / Micro etched / Polished / Velvet Waterproof and anti-graffiti protection

Several elements can be combined to create a planter

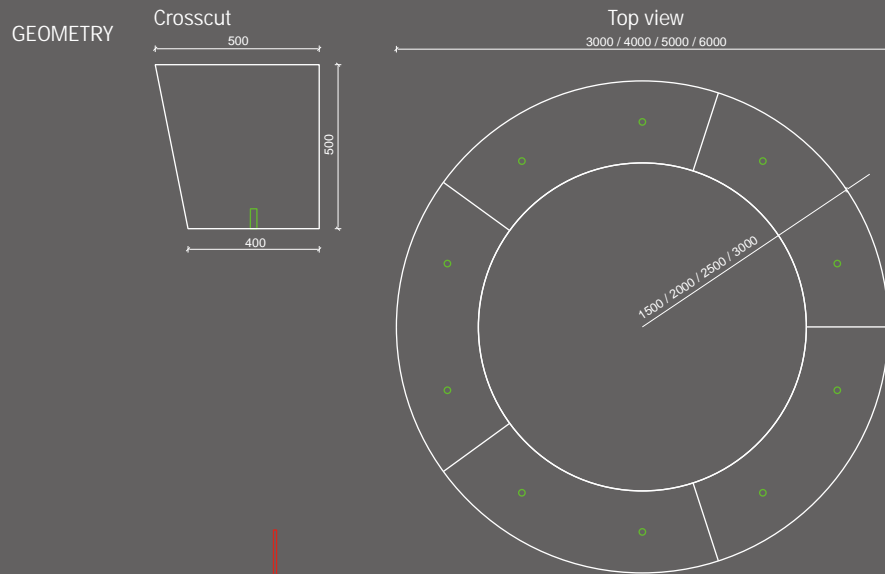

Circular	Dia 300 cm - 4.240 kg - 848 kg/part - 5 parts
	Dia 400 cm - 5.940 kg - 990 kg/part - 6 parts
	Dia 500 cm - 7.632 kg - 954 kg/part - 8 parts
	Dia 600 cm - 9.324 kg - 1.036 kg/part - 9 parts

HANDLING

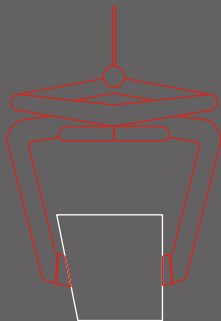

Perimeter is easily noticeable with white cane.
Appropriate seat height. Easy to stand-up thanks to back slope under seating.
Volume is easily understandable and friendly for people with cognitive disabilities.





Designer: Jan Contreras (BE)

SPECIFICATIONS

MATERIAL	Cast stone
FIXING	Free-standing
WEIGHT	A - 280 kg / B - 280 kg / C - 340 kg
FINISHES	Micro etched Waterproof and anti-graffiti protection



GEOMETRY

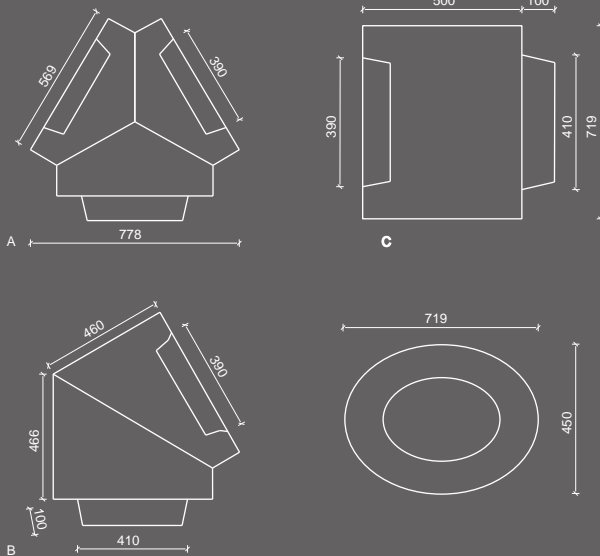

HANDLING

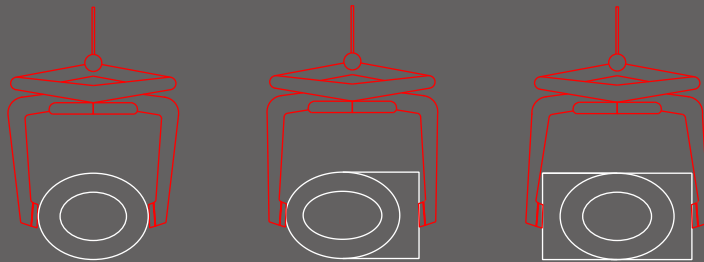

Perimeter is easily noticeable with white cane.



Designer: Benjamin Pawlica (FR)

SPECIFICATIONS

MATERIAL	Cast stone
FIXING	2x M12 Shelve - length 200 mm
WEIGHT	360 kg
FINISHES	Micro etched / Polished / Velvet Waterproof and anti-graffiti protection



GEOMETRY

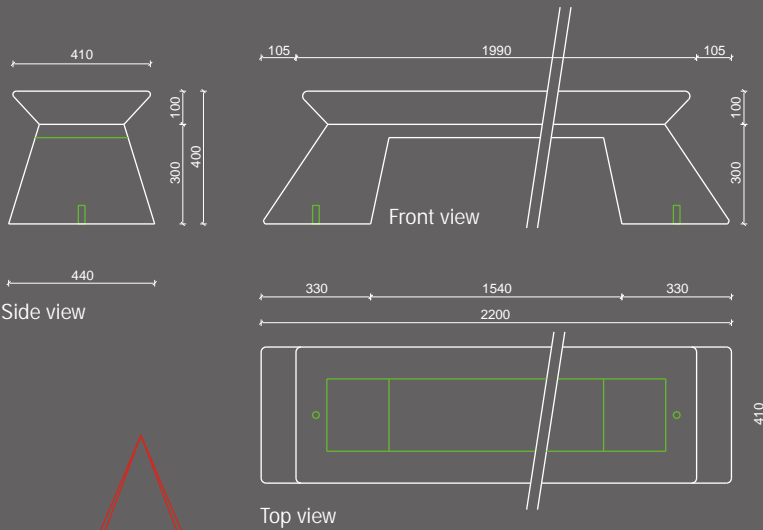

HANDLING

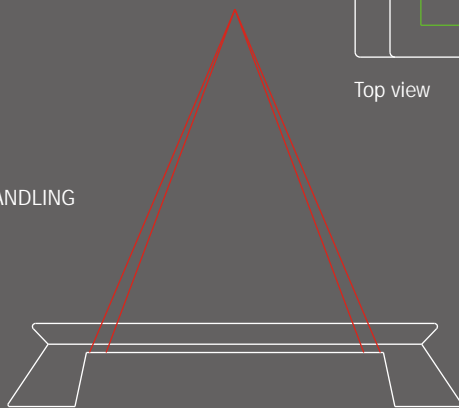

Perimeter is easily noticeable with white cane.
 Easy to stand-up thanks to back slope under seating.
 Volume is easily understandable and friendly for people with cognitive disabilities.