

BOLLARDS

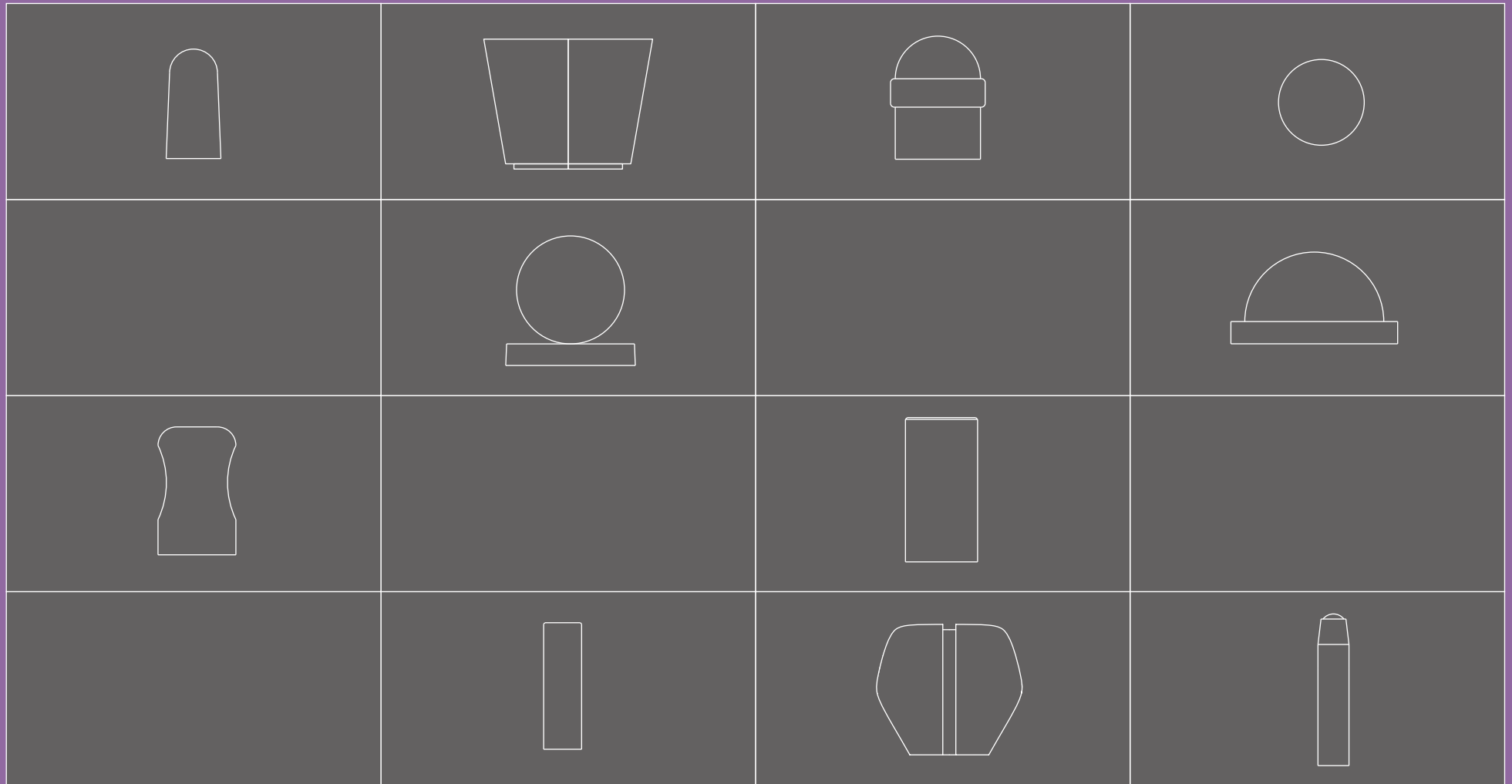



Designers: Crous Calogero (ES)

SPECIFICATIONS

MATERIAL	Cast stone
FIXING	1x M12 Shelve - length 200 mm
WEIGHT	155 kg
FINISHES	Micro etched / Polished / Velvet Waterproof and anti-graffiti protection



GEOMETRY

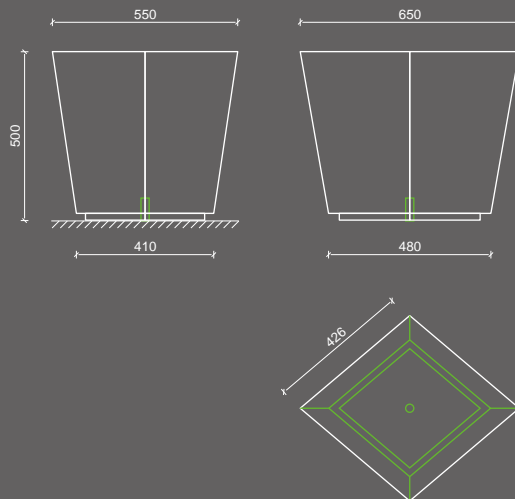

HANDLING

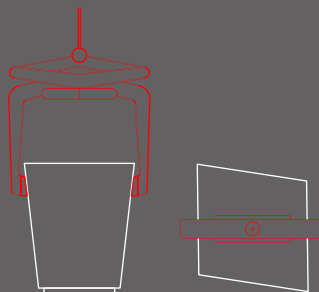

Perimeter is easily noticeable with white cane.
Can be used as relay seating for people easily exhausted. Appropriate height. Easy to stand-up thanks to back slope under seating.
Volume is easily understandable and friendly for people with cognitive disabilities.





Designers:
Karen Schou Andersen & Hans Christian Asmussen (DK)

SPECIFICATIONS

MATERIALS	Cast stone Stainless steel stripe with optional reflective sticker
FIXING	1x M12 Shelve - length 200 mm
WEIGHT	190 kg
FINISHES	Fair faced / Micro etched / Polished / Velvet Waterproof and anti-graffiti protection



GEOMETRY

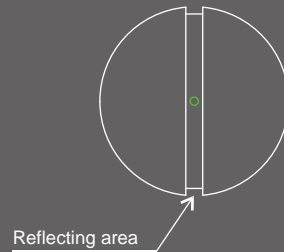
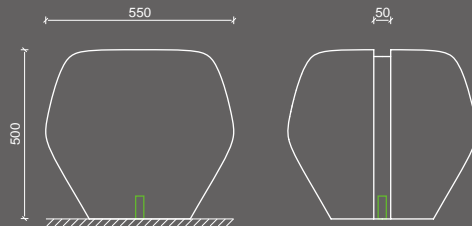

HANDLING

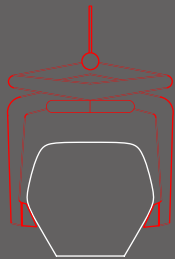

Reflecting stripe for people with impaired eyesight and for drivers. Perimeter is easily noticeable with white cane. Can be used as relay seating for people easily exhausted. Appropriate height. Volume is easily understandable and friendly for people with cognitive disabilities.





SPECIFICATIONS

MATERIAL	Cast stone
FIXING	1x M12 Shelve - length 200 mm
WEIGHT	195 kg
FINISHES	Fair faced / Micro etched / Polished / Velvet Waterproof and anti-graffiti protection



GEOMETRY

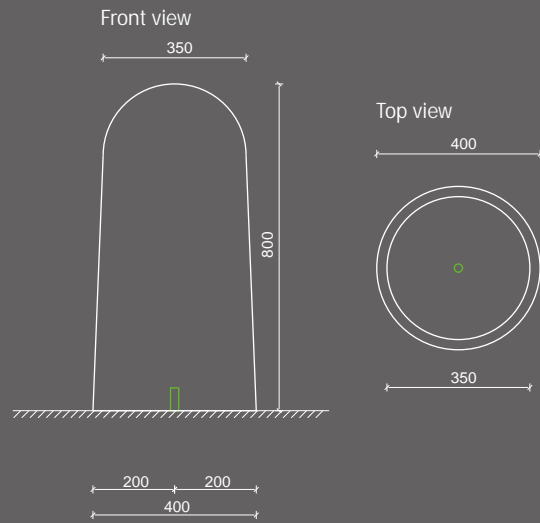

HANDLING

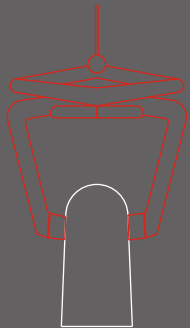

Perimeter is easily noticeable with white cane.
Volume is easily understandable and friendly for people with cognitive disabilities.





SPECIFICATIONS

MATERIAL	Cast stone
FIXING	1x M12 Shelve - length 200 mm
WEIGHT	235 kg
FINISHES	Micro etched Waterproof and anti-graffiti protection

GEOMETRY

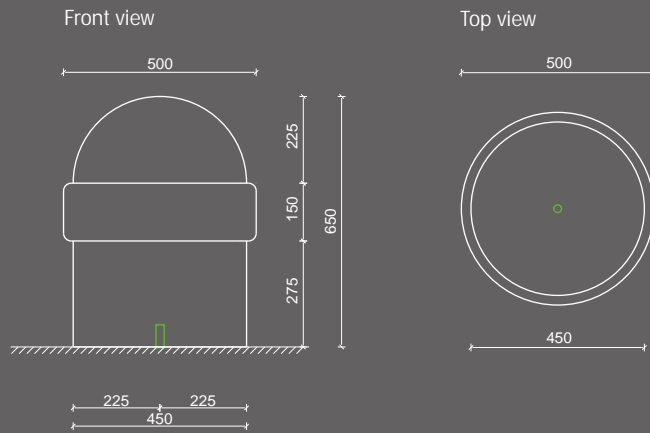

HANDLING

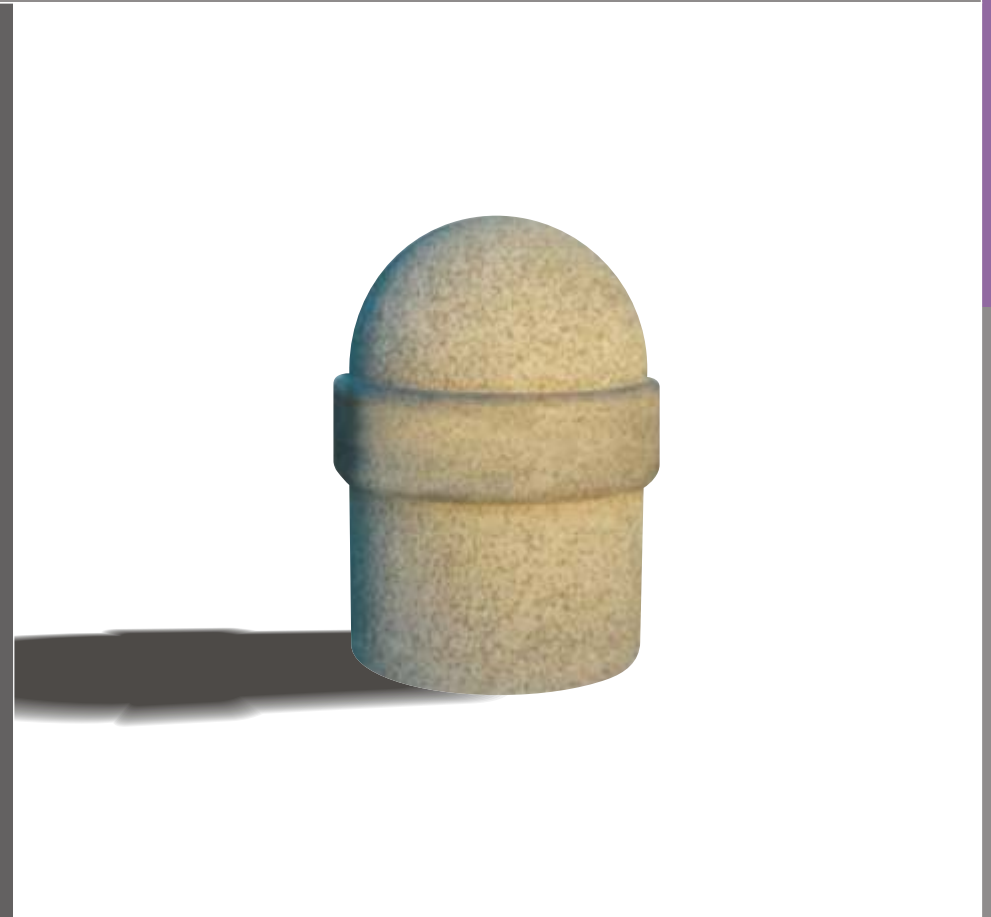
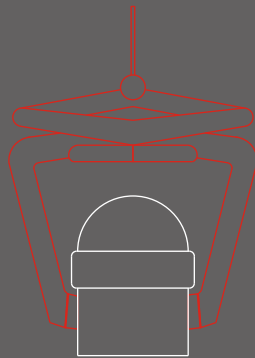

Perimeter is easily noticeable with white cane.
Volume is easily understandable and friendly for people with cognitive disabilities.





SPECIFICATIONS

MATERIAL	Cast stone
FIXING	1x M12 Shelve - length 200 mm
WEIGHT	see table
FINISHES	Fair faced / Micro etched / Polished / Velvet Waterproof and anti-graffiti protection



GEOMETRY

Front view

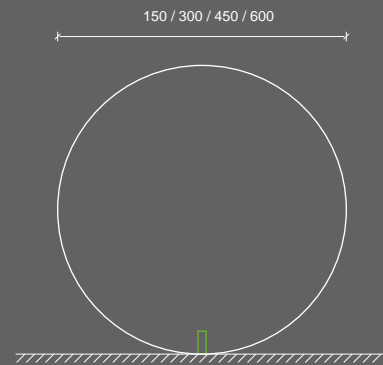

HANDLING

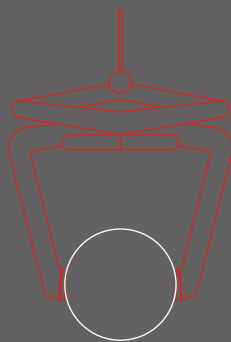

- Round 15 - dia 15 cm - 5 kg
- Round 30 - dia 30 cm - 32 kg
- Round 45 - dia 45 cm - 110 kg
- Round 60 - dia 60 cm - 260 kg
- Round 80 - dia 80 cm - 643 kg



Perimeter is easily noticeable with white cane. Although, we do not recommend to use small spheres (15-30 cm) in heavy pedestrian traffic areas. Volume is easily understandable and friendly for people with cognitive disabilities.





SPECIFICATIONS

MATERIAL	Cast stone
FIXING	1x M12 Shelve - length 200 mm
WEIGHT	245 kg
FINISHES	Micro etched Waterproof and anti-graffiti protection

GEOMETRY

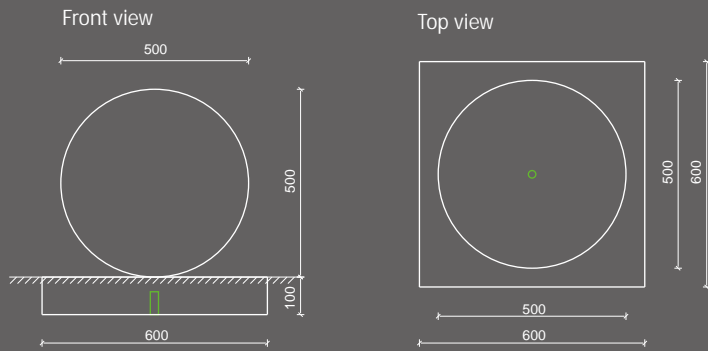

HANDLING

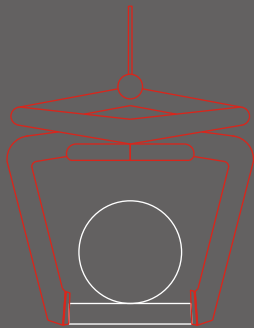

Bollard Stablio



Perimeter is easily noticeable with white cane.
Volume is easily understandable and friendly for people with cognitive disabilities.





SPECIFICATIONS

MATERIAL	Cast stone
FIXING	1x M12 Shelve - length 200 mm
WEIGHT	148 kg
FINISHES	Fair faced / Micro etched Waterproof and anti-graffiti protection



GEOMETRY

Front view

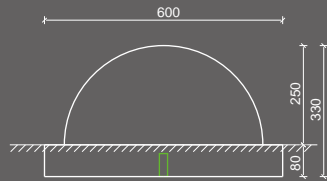

Top view

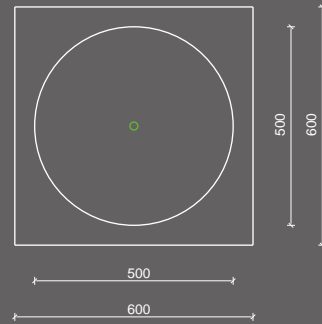

HANDLING

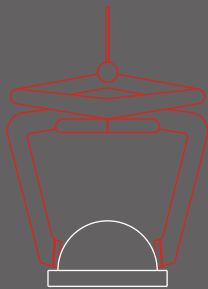



SPECIFICATIONS

MATERIAL	Cast stone
FIXING	1x M12 Shelve - length 200 mm
WEIGHT	160 kg
FINISHES	Micro etched Waterproof and anti-graffiti protection



Bollard Porta

GEOMETRY

Front view

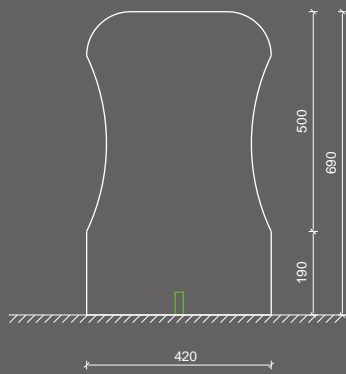

Top view

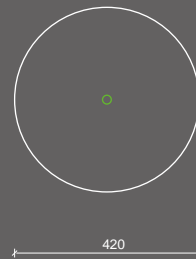

HANDLING

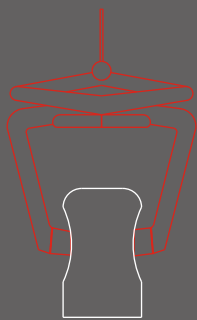

Perimeter is easily noticeable with white cane.
Can be used as relay seating for people easily exhausted if buried partly, leaving 50-55 cm out of ground.
Volume is easily understandable and friendly for people with cognitive disabilities.





SPECIFICATIONS

MATERIAL	Cast stone
FIXING	1x M12 Shelve - length 200 mm
WEIGHT	253 kg
FINISHES	Fair faced / Micro etched Waterproof and anti-graffiti protection

GEOMETRY

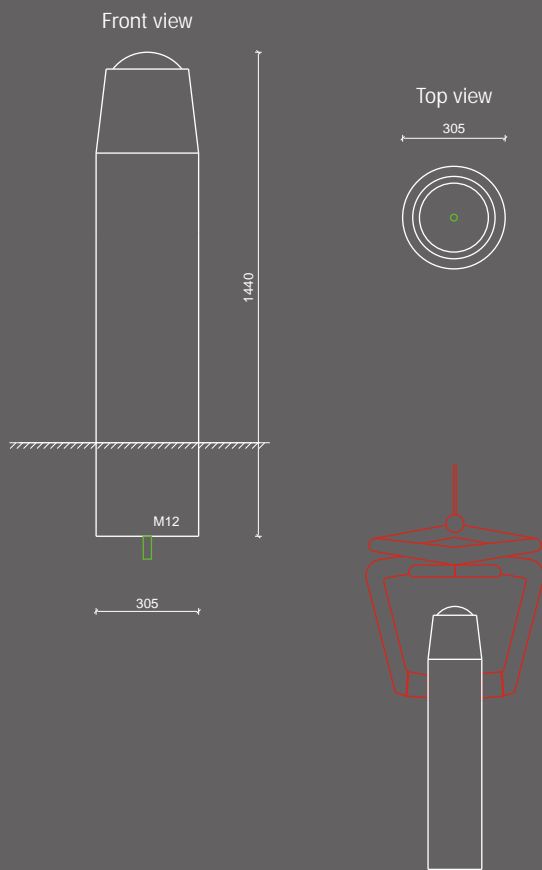

Perimeter is easily noticeable with white cane.
Volume is easily understandable and friendly for people with cognitive disabilities.





SPECIFICATIONS

MATERIAL	Cast stone
FIXING	1x M12 Shelve - length 200 mm
WEIGHT	300 kg
FINISHES	Fair faced / Micro etched / Polished / Velvet Waterproof and anti-graffiti protection



GEOMETRY

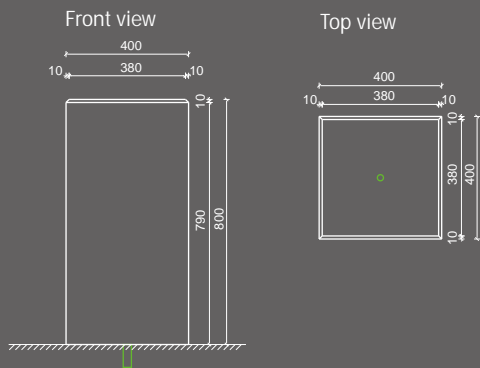

HANDLING

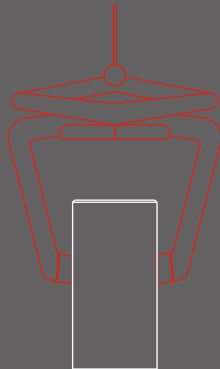

Bollard Cubo



Perimeter is easily noticeable with white cane.
 Can be used as relay seating for people easily exhausted if buried partly, leaving 50-55 cm out of ground.
 Volume is easily understandable and friendly for people with cognitive disabilities.





SPECIFICATIONS

MATERIAL	Cast stone
FIXING	1x M12 Shelf - length 200 mm
WEIGHT	see table
FINISHES	Fair faced / Micro etched / Polished / Velvet Waterproof and anti-graffiti protection



GEOMETRY

Top view

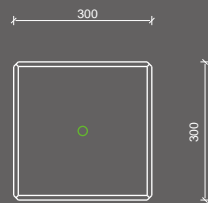

Front view

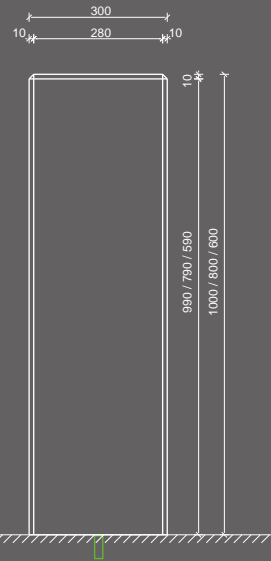

HANDLING

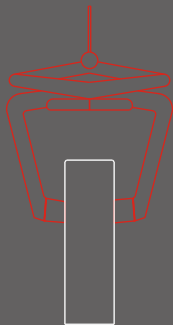

Hanso h100 cm - 216 kg

h80 cm - 172 kg

h60 cm - 130 kg



Perimeter is easily noticeable with white cane.
Volume is easily understandable and friendly for people with cognitive disabilities.

