

PLANTERS





Designer: Alain Gilles (BE)

SPECIFICATIONS

| | |
|----------|---|
| MATERIAL | Cast stone |
| FIXING | Free-standing |
| WEIGHT | 360 kg |
| FINISHES | Micro etched / Polished / Velvet |
| | Waterproof and anti-graffiti protection |



GEOMETRY

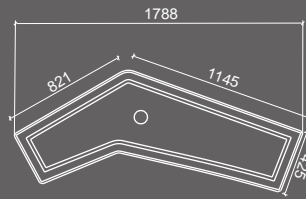

Top view

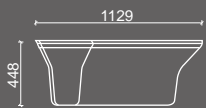

Side view



Front view

HANDLING

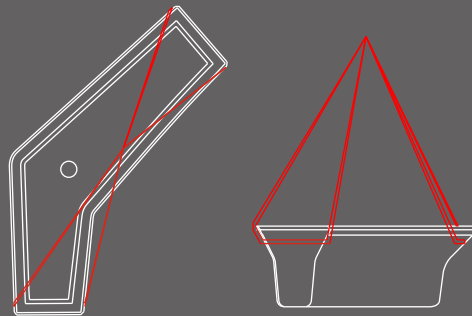

People in wheelchair can easily approach the planter and touch the plants. Perimeter is easily noticeable with white cane.



SPECIFICATIONS

| | |
|----------|---|
| MATERIAL | Cast stone |
| FIXING | Free-standing |
| WEIGHT | 4.320 kg |
| FINISHES | Micro etched / Polished / Velvet Waterproof and anti-graffiti protection |



GEOMETRY

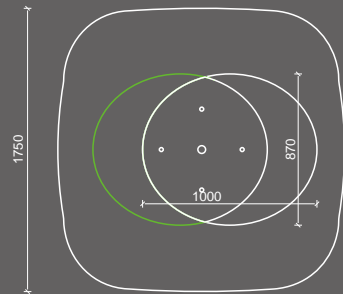
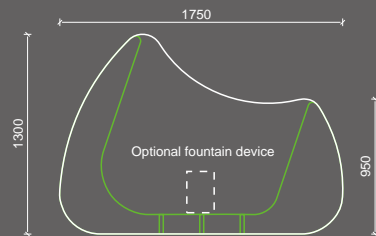

HANDLING

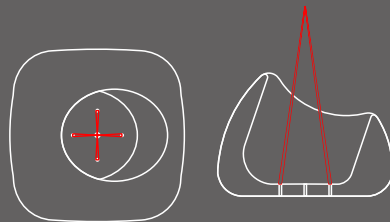

Planter Coast



Perimeter is easily noticeable with white cane.
Volume is easily understandable and friendly for people with cognitive disabilities.





Designer: Benjamin Pawlica (FR)

SPECIFICATIONS

| | |
|----------|---|
| MATERIAL | Cast stone |
| FIXING | Free-standing |
| WEIGHT | 295 kg |
| FINISHES | Micro etched Waterproof and anti-graffiti protection |



GEOMETRY

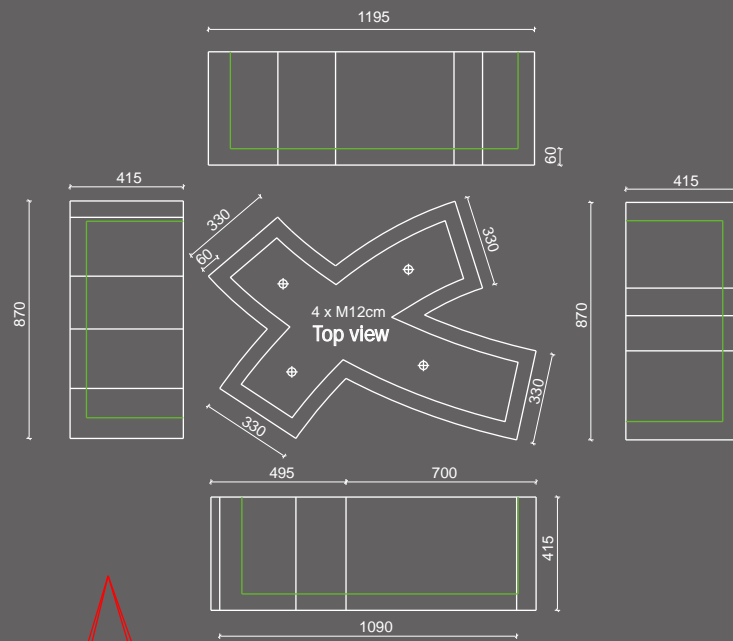

HANDLING

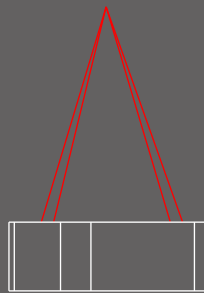

Perimeter is easily noticeable with white cane.



Designer: Roel Vandebeek (BE)

SPECIFICATIONS

| | |
|----------|---|
| MATERIAL | Cast stone |
| FIXING | Incorporated |
| WEIGHT | 600 kg |
| FINISHES | Micro etched / Polished / Velvet Waterproof and anti-graffiti protection |



Planter Pop Up

GEOMETRY

Top view

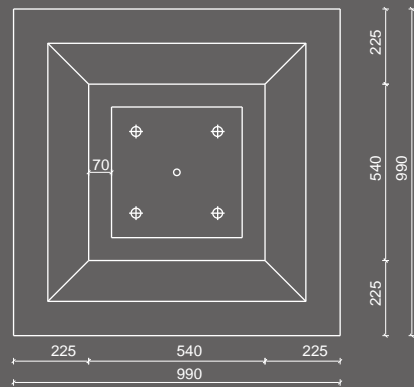

Crosscut

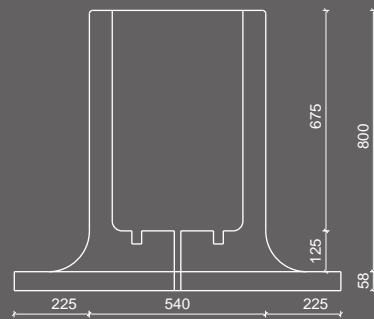

HANDLING

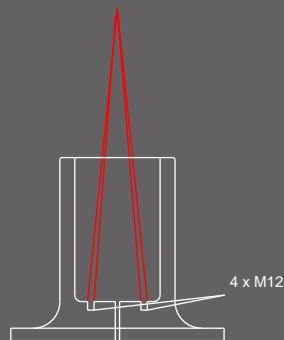

Perimeter is easily noticeable with white cane.



SPECIFICATIONS

| | |
|----------|---|
| MATERIAL | Cast stone |
| FIXING | Free-standing |
| WEIGHT | 370 kg |
| FINISHES | Micro etched Waterproof and anti-graffiti protection |



GEOMETRY

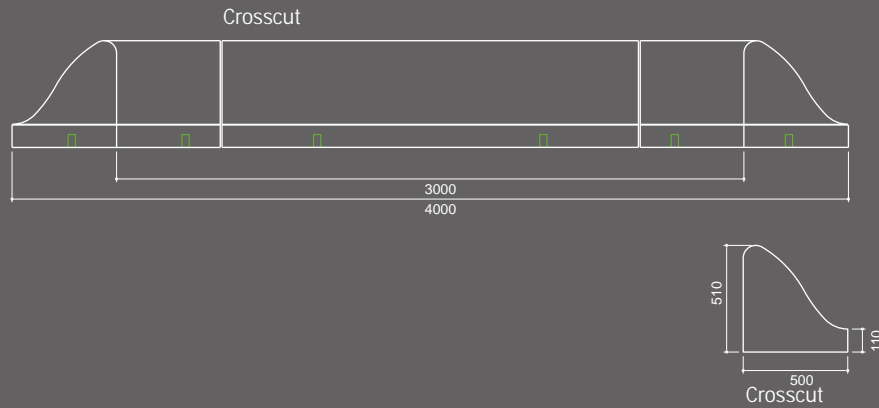

HANDLING

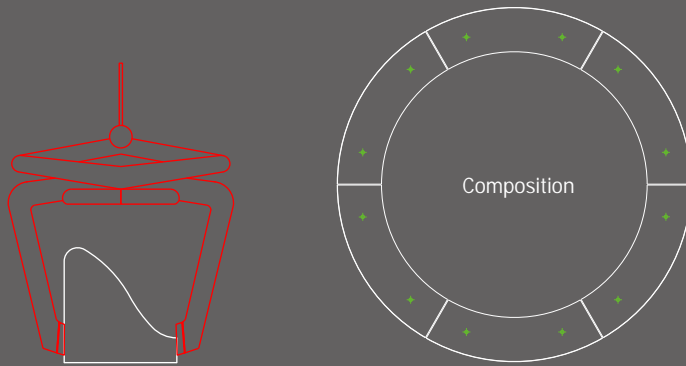

Perimeter is easily noticeable with white cane.



Designer: Arne Quinze (BE)

SPECIFICATIONS

| | |
|----------|---|
| MATERIAL | Cast stone |
| FIXING | Free-standing |
| WEIGHT | 370 kg |
| FINISHES | Micro etched Waterproof and anti-graffiti protection |



GEOMETRY

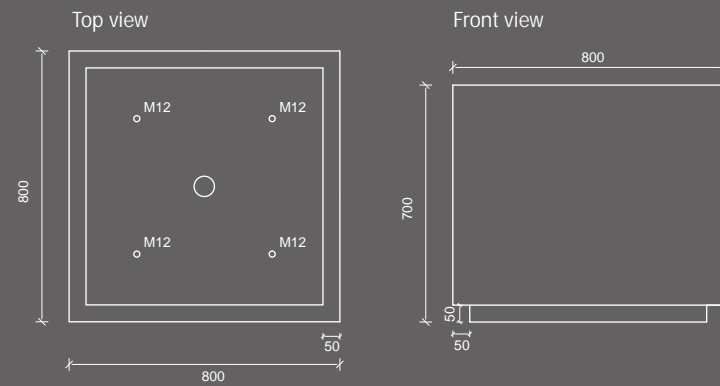

HANDLING

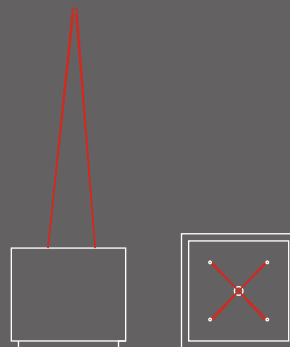

Perimeter is easily noticeable with white cane.



SPECIFICATIONS

| | |
|----------|---|
| MATERIAL | Cast stone |
| FIXING | Free-standing |
| WEIGHT | 980 kg |
| FINISHES | Micro etched / Polished / Velvet Waterproof and anti-graffiti protection |

GEOMETRY

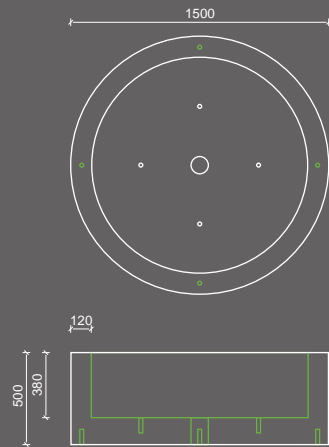

HANDLING

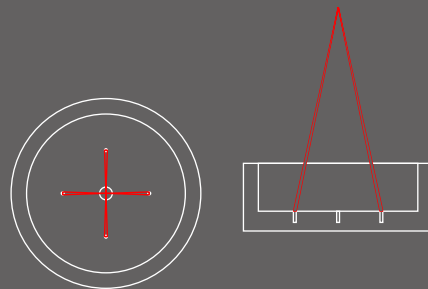

Perimeter is easily noticeable with white cane.





SPECIFICATIONS

| | |
|----------|---|
| MATERIAL | Cast stone |
| FIXING | Free-standing |
| WEIGHT | see table |
| FINISHES | Micro etched Waterproof and anti-graffiti protection |



Planter Luna S & Luna R

GEOMETRY

Top view

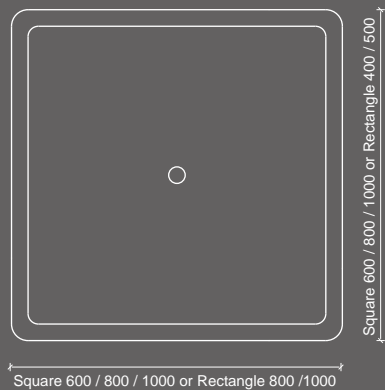

Front view

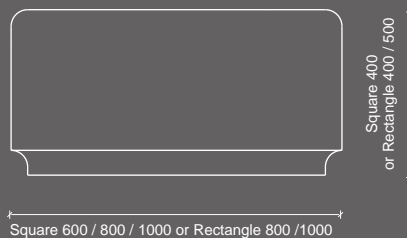

Side view

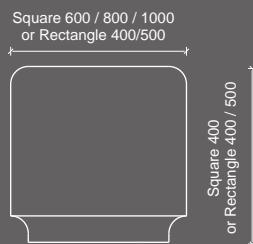

HANDLING

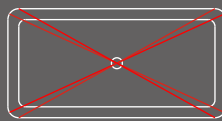
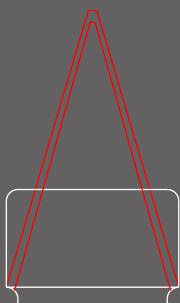

- Luna S - 60/60/40 cm - 230 kg
- Luna S - 80/80/40 cm - 270 kg
- Luna S - 100/100/40 cm - 370 kg
- Luna R - 80/40/40 cm - 180 kg
- Luna R - 100/50/50 cm - 230 kg



Perimeter is easily noticeable with white cane.





SPECIFICATIONS

MATERIAL Cast stone
 FIXING Free-standing
 WEIGHT Dia 80 cm - 220 kg / Dia 100 cm - 410 kg
 100/80 cm - 290 kg
 FINISHES Micro etched
 Waterproof and anti-graffiti protection



GEOMETRY

Front view



Top view

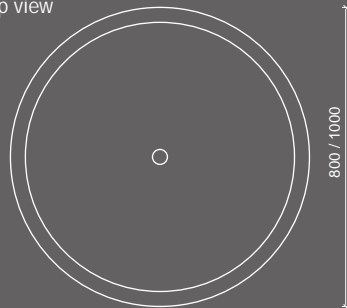

HANDLING

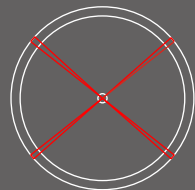
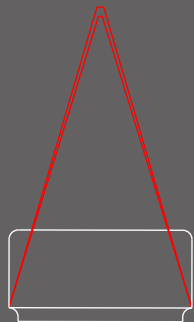

GEOMETRY

Top view

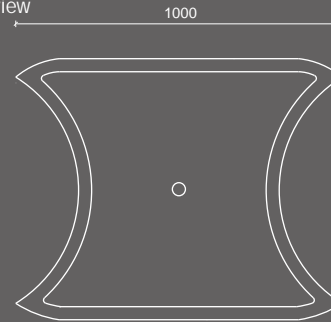

Front view

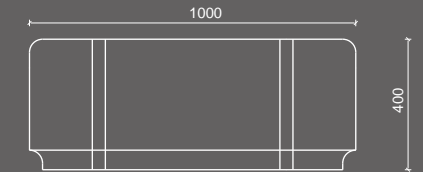

HANDLING

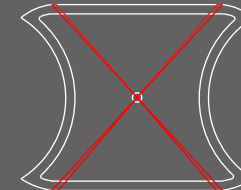
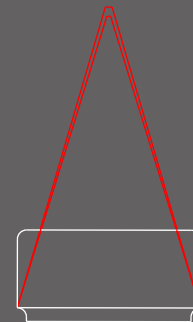

Perimeter is easily noticeable with white cane.





SPECIFICATIONS

MATERIAL Cast stone
 FIXING Free-standing
 WEIGHT see table

FINISHES Fair faced / Micro etched / Polished / Velvet
 Waterproof and anti-graffiti protection



Planter Carree

GEOMETRY

Top view

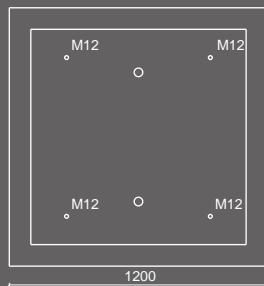

Crosscut



Top view

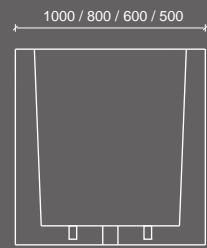
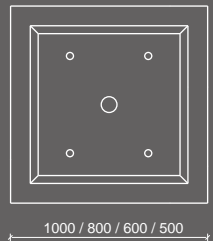

Crosscut

HANDLING

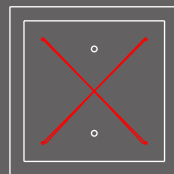
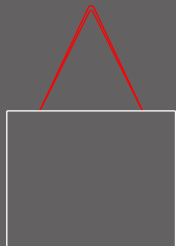

Carree 120 - 120/120/50 cm - 10 cm thick - 950 kg

Carree 100 - 100/100/100 cm - 10 cm thick - 1.017 kg

Carree 80 - 80/80/80 cm - 8 cm thick - 522 kg

Carree 60 - 60/60/60 cm - 6 cm thick - 230 kg

Carree 50 - 50/50/50 cm - 5 cm thick - 110 kg



Perimeter is easily noticeable with white cane.





SPECIFICATIONS

MATERIAL Cast stone
 FIXING Free-standing
 WEIGHT 1.090 kg

FINISHES Fair faced / Micro etched / Polished / Velvet
 Waterproof and anti-graffiti protection



GEOMETRY

Top view

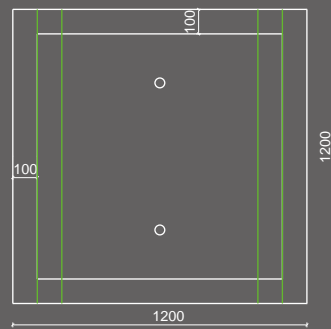

Crosscuts

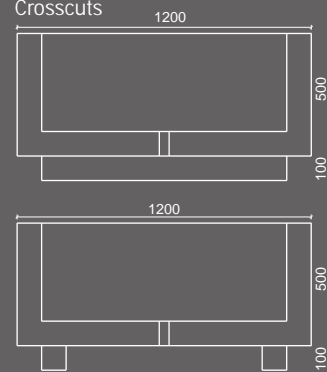

HANDLING

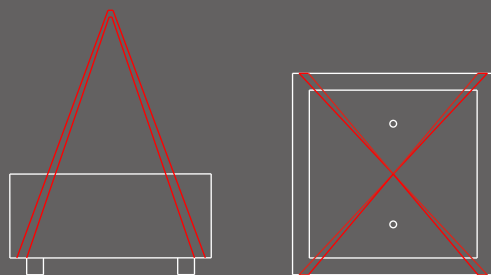

Perimeter is easily noticeable with white cane.



SPECIFICATIONS

| | |
|----------|--|
| MATERIAL | Cast stone |
| FIXING | Free-standing |
| WEIGHT | 1.850 kg |
| FINISHES | Fair faced / Micro etched / Polished / Velvet Waterproof and anti-graffiti protection |



GEOMETRY

Top view

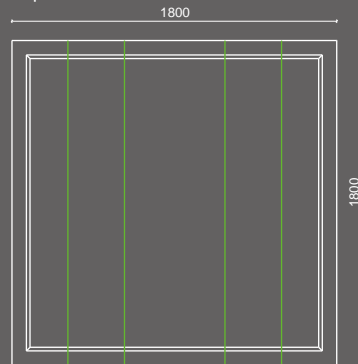

Front view

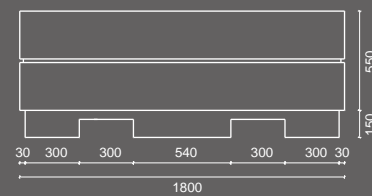

HANDLING

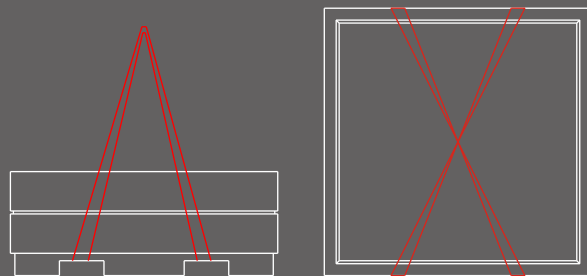

Planter Ligna



Perimeter is easily noticeable with white cane.





SPECIFICATIONS

MATERIAL Cast stone
 FIXING Free-standing
 WEIGHT see table

FINISHES Fair faced / Micro etched / Polished / Velvet
 Waterproof and anti-graffiti protection

GEOMETRY

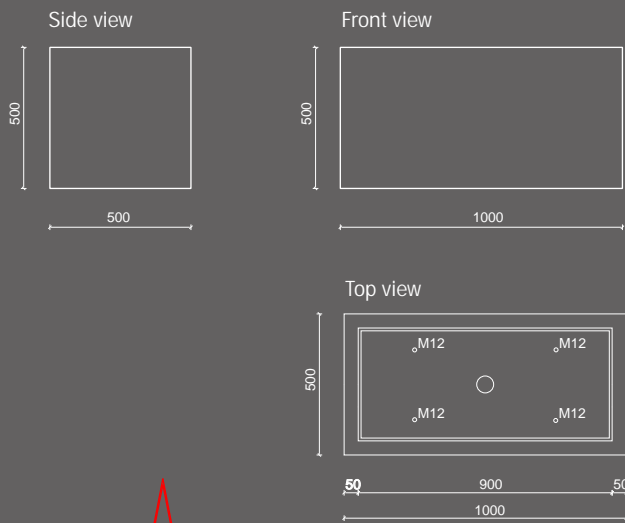

HANDLING

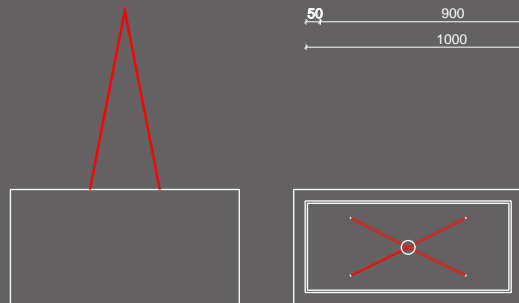

- Recto 2010 - 200/100/100 cm - 10 cm thick - 1.690 kg
- Recto 1510 - 150/100/100 cm - 10 cm thick - 1.353 kg
- Recto 1575 - 150/75/75 cm - 8 cm thick - 753 kg
- Recto 1050 - 100/50/50 cm - 5 cm thick - 220 kg



Perimeter is easily noticeable with white cane.