

# Highways

Product Range

*"Brand new solutions  
for tomorrow's world"*







## Passive safety

Leafield Environmental is an active member of the Passive Revolution and produces highway products that are passively safe and tested to BS12767 Passive Safety of Non Harmful Structures.

## Sustainability

Our products are principally manufactured using Medium Density Polyethylene (MDPE) which is 100% recyclable at the end of the product in-service life. In addition we offer a range of ECO Bollards that are produced using a 50% content of chipped plastic bottles. We are also using the highest visibility Diamond Grade, fluorescent, retro reflective materials and helping to reduce carbon emissions from street lighting.

## Testing against the highest standard

Night Owl has been independently tested and passes, at 70 km/h, BS8442:2006 (14) Retro Reflective Bollards, the highest standard for Keep Left bollards.

## Cost effectiveness

Using Polyethylene makes our highway products extremely durable and able to withstand tough urban environments with little or no in-service maintenance. This makes them a very cost effective choice compared with cast or steel bollards that require repainting or regular protection from rust.





With thanks to Hull City Council and Humberside Fire and Rescue.

## Range and choice

This brochure showcases our extensive range of highway bollards and winter maintenance products in a wide choice of formats and finishes. In addition we are pleased to discuss specific 'personalisation', (logos, messages etc) that may be required.

## Working with you

We work with you our customers and with other manufacturers to produce total highway solutions. See the video and case study from Hull where we worked with Streetscene Engineers and the Humberside Fire and Rescue Service. Also look at the use of Night Owl on composite Traffic Islands produced by Rediwell.

**Call 01189 404717 to find out more**

# Contents

## Signs & Sign Bollards

Night Owl

4 – 5

Linsign 300

6 – 7

Linsign 230

8 – 9



## Roadside Storage Bins/ Sentry Sign & Barrier

Roadside Storage Bins/Sentry Signs

10 – 11



## Bollard Product Selector

12– 13

**Bollard Product Selector**

**Choice of Material**

**Standard**

**Chastity (Decorative) Acrylic (DCA)**

10 | Lislefield | 118

## Bollards

Heritage

14 – 15

Regency & Woburn

16 – 17

Sentinel

18 – 19

Monarch, Sterling & Edgeminder

20 – 21

Vergemarker

22 – 23



## Colours

Colour chart

23



# Nightowl

Setting a new standard\*  
for Self Righting Bollards.



## Sign Suggestions Highway Use

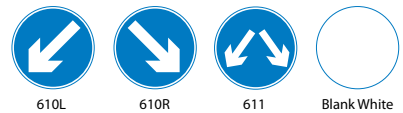

## Non Highway Use



For further sign options please contact  
Customer Services, telephone  
01189 404717 .





# Night Owl™ is an all plastic, recyclable, passively safe, self righting 'Keep Left' bollard comprising a 'bounce back' base unit and replaceable rigid sign carrier.

Night Owl has passed BS8442:2006, 'Retro Reflective Self Righting Bollards' which requires products to remain intact, returning to an upright position after a 70 km/h impact without reducing the speed of the vehicle by more than 3km/h.

Night Owl has particular application as a Keep Left bollard providing a durable, low maintenance cost, reduced carbon footprint solution for traffic islands in general.

See the Night Owl brochure for detailed information.

Night Owl is a Trademark of Leaffield Environmental Ltd



## Night Owl

✓ PASSIVE      ✓ REFLEX      ✓ BS 8442

### Choose from

Single Sided  
Double Sided

### Fixing Options

Surface Mounted  
Concrete Anchor (used in the MIRA Test)  
Adapter Plates for existing fixings

### Colours (see page 23)

Black, white & grey for Highways use  
Standard & Premium (for non Highways use)

### Sign Options

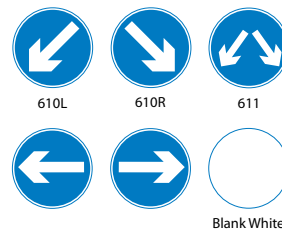

Single Sided, Sign & Panel  
Double Sided, 2 signs & 1 Panel  
Double Sided 1 sign & 2 Panels  
Double Sided 2 Signs & 2 Panels

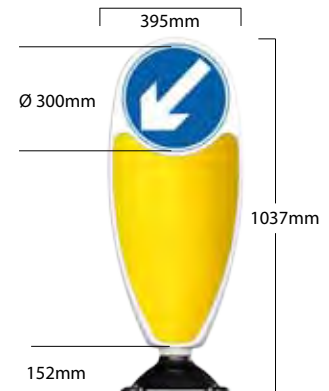

### Specification

Side reflector: 53.5mm wide  
Weight: 6kg  
Material: MDPE

All dimensions and weights are nominal

*\*Night Owl has passed BS8442:2006 (14) Retro Reflective Self Righting Bollards*



## Bounce Back Base

✓ PASSIVE      ✓ REFLEX      ✓ BS 8442

### Fixing Options

Surface Mounted  
Concrete Anchor (used in the MIRA Test)  
Adapter Plates for existing installations

### Colours (see page 23)

Black



### Fixing Options

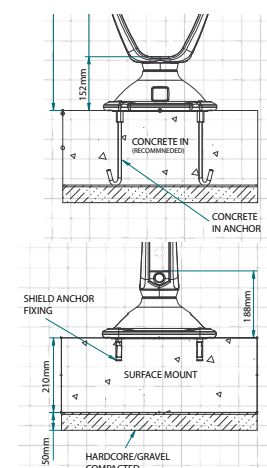

### Specification

Ground fixing centres: 228 x 228mm  
Weight: 1.6kg  
Material: Reflex PE

All dimensions and weights are nominal



Linsign 300  
Traffic bollard and low level sign...  
for a wide range of applications.

### Sign Suggestions



Sign  
profile

Double Single



For further sign options please contact Customer Services,  
telephone 01189 404717 .

### Sentinel Linsign 300 Visibol

#### Choose from

Sentinel Linsign 300 Visibol Standard or ECO  
Single Sided Sign profile  
or Double Sided Sign profile (see left)

#### Fixing Options\*

Sentinel Linsign 300 Visibol Standard All  
Sentinel Linsign 300 Visibol ECO PM, AR & S

#### Colours (see page 23)

Standard & Premium  
ECO

#### Banding

Choice of Class ref 1 & Class ref 2 British  
Standard Reflective banding available.  
Aluminium backed for vandal resistance.  
See page 13.

#### Banding Ideas



Left to right:

Light Grey: Blue Reflective Band  
Black: All Yellow Reflective Band  
Black: Yellow Reflective Band  
Sandstone: Red/White Reflective Band

\*PM - Permanent, AR - Anti-Ram, S - Socketed, SM - Surface





## Heritage Linsign 300

✓ ECO ✓ Class ref 1&2

### Choose from

Heritage Linsign 300 Standard or ECO  
Single Sided Sign profile  
or Double Sided Sign profile (see page 6)

### Fixing Options\*

Heritage Linsign 300 Standard All  
Heritage Linsign 300 ECO PM, AR & S

### Colours (see page 23)

Standard & Premium  
ECO

### Banding

Choice of Class ref 1 & Class ref 2 British  
Standard Reflective banding available.  
Aluminium backed for vandal resistance.  
Decorative banding is optional see page 13.

\*PM - Permanent, AR - Anti-Ram, S - Socketed, SM - Surface

### Banding Ideas



Left to right:

**Light Grey:** White Reflective Band,  
Blue Decorative Band  
**Sandstone:** Red/White Reflective Band  
**Black:** Yellow Reflective Band



### Specification

Weight: Less than 7kg  
Material: MDPE

All dimensions and weights are nominal

## Heritage Linsign 300 Visibol

✓ ECO ✓ Class ref 1&2

### Choose from

Heritage Linsign 300 Visibol Standard or ECO  
Single Sided Sign profile  
or Double Sided Sign profile (see page 6)

### Fixing Options\*

Heritage Linsign 300 Visibol Standard All  
Heritage Linsign 300 Visibol ECO PM, AR & S

### Colours (see page 23)

Standard & Premium  
ECO

### Banding

Choice of Class ref 1 & Class ref 2 British  
Standard Reflective banding available.  
Aluminium backed for vandal resistance.  
Decorative banding is optional see page 13.

\*PM - Permanent, AR - Anti-Ram, S - Socketed, SM - Surface

### Banding Ideas



Left to right:

**Blue:** Blue Reflective Band,  
Blue Decorative Band  
**Yellow:** All Yellow Reflective  
& Decorative Band  
**Black:** Yellow Reflective Band  
**Sandstone:** Red/White Reflective Band

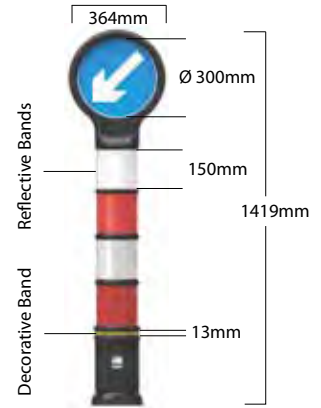

### Specification

Weight: Less than 7kg  
Material: MDPE

All dimensions and weights are nominal

✓ ECO ✓ Class ref 1&2

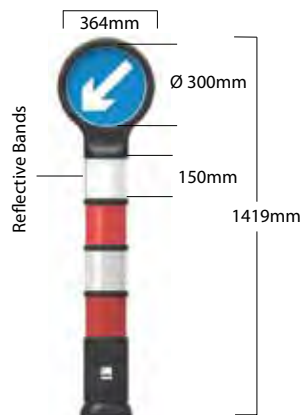

### Specification

Weight: Less than 7kg  
Material: MDPE

All dimensions and weights are nominal

## Sentinel Linsign 300

✓ ECO ✓ Class ref 1&2

### Choose from

Sentinel Linsign 300 Standard or ECO  
Single Sided Sign profile  
or Double Sided Sign profile (see page 6)

### Fixing Options\*

Sentinel Linsign 300 Standard All  
Sentinel Linsign 300 ECO PM, AR & S

### Colours (see page 23)

Standard & Premium  
ECO

### Banding

Choice of Class ref 1 & Class ref 2 British  
Standard Reflective banding available.  
Aluminium backed for vandal resistance.  
See page 13.

\*PM - Permanent, AR - Anti-Ram, S - Socketed, SM - Surface

### Banding Ideas



Left to right:

**Light Grey:** White Reflective Band  
**Sandstone:** Red/White Reflective Band  
**Black:** Yellow Reflective Band



### Specification

Weight: Less than 7kg  
Material: MDPE

All dimensions and weights are nominal

# Linsign 230

Traffic bollard and low level sign...  
ideal for parking control applications.



## Sign Suggestions



### Sign profiles

Double      Single



For further sign options please contact Customer Services, telephone 01189 404717.

## Sentinel Linsign 230 Visibol

### Choose from

Sentinel Linsign 230 Visibol Standard or ECO  
Single Sided Sign profile  
or Double Sided Sign profile (see left)

### Fixing Options\*

Sentinel Linsign 230 Visibol Standard      All  
Sentinel Linsign 230 Visibol ECO      PM, AR & S

### Colours (see age 23)

Standard & Premium  
ECO

### Banding

Choice of Class ref 1 & Class ref 2 British  
Standard Reflective banding available.  
Aluminium backed for vandal resistance.  
See page 13.

### Banding Ideas



Left to right:

Light Grey:      Blue Reflective Band  
Black:            Yellow Reflective Bands  
Black:            All Yellow Reflective Bands  
Sandstone:      Red/White Reflective Band

\*PM - Permanent, AR - Anti-Ram, S - Socketed, SM - Surface





## Heritage Linsign 230

✓ ECO      ✓ Class ref 1&2

### Choose from

Heritage Linsign 230 Standard or ECO  
Single Sided Sign profile  
or Double Sided Sign profile (see page 8)

### Fixing Options\*

Heritage Linsign 230 Standard      All  
Heritage Linsign 230 ECO      PM, AR & S

### Colours (see page 23)

Standard & Premium  
ECO

### Banding

Choice of Class ref 1 & Class ref 2 British  
Standard Reflective banding available.  
Aluminium backed for vandal resistance.  
Decorative banding is optional see page 13.

\*PM - Permanent, AR - Anti-Ram, S - Socketed, SM - Surface

### Banding Ideas



Left to right:

**Light Grey:** White Reflective Band,  
Blue Decorative Band  
**Sandstone:** Red/White Reflective Band  
**Black:** Yellow Reflective Band

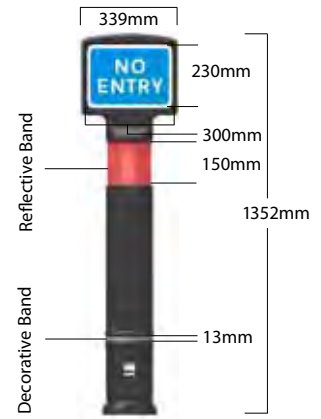

### Specification

Weight: Less than 7kg  
Material: MDPE

All dimensions and weights are nominal



## Heritage Linsign 230 Visibol

✓ ECO      ✓ Class ref 1&2

### Choose from

Heritage Linsign 230 Visibol Standard or ECO  
Single Sided Sign profile  
or Double Sided Sign profile (see page 8)

### Fixing Options\*

Heritage Linsign 230 Visibol Standard      All  
Heritage Linsign 230 Visibol ECO      PM, AR & S

### Colours (see page 23)

Standard & Premium  
ECO

### Banding

Choice of Class ref 1 & Class ref 2 British  
Standard Reflective banding available.  
Aluminium backed for vandal resistance.  
Decorative banding is optional see page 13.

\*PM - Permanent, AR - Anti-Ram, S - Socketed, SM - Surface

### Banding Ideas



Left to right:

**Light Grey:** Blue Reflective Band,  
Blue Decorative Band  
**Black:** Yellow Reflective Band  
**Black:** All Yellow Reflective  
& Decorative Band  
**Sandstone:** Red/White Reflective Band

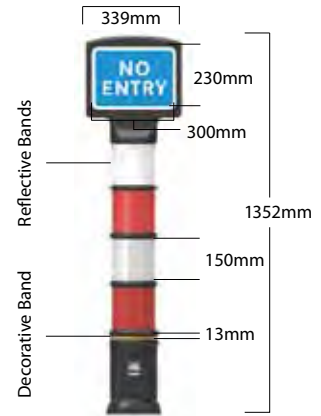

### Specification

Weight: Less than 7kg  
Material: MDPE

All dimensions and weights are nominal

✓ ECO      ✓ Class ref 1&2

## Sentinel Linsign 230

✓ ECO      ✓ Class ref 1&2

### Choose from

Sentinel Linsign 230 Standard or ECO  
Single Sided Sign profile  
or Double Sided Sign profile (see page 8)

### Fixing Options\*

Sentinel Linsign 230 Standard      All  
Sentinel Linsign 230 ECO      PM, AR & S

### Colours (see page 23)

Standard & Premium  
ECO

### Banding

Choice of Class ref 1 & Class ref 2 British  
Standard Reflective banding available.  
Aluminium backed for vandal resistance.  
See page 13.

\*PM - Permanent, AR - Anti-Ram, S - Socketed, SM - Surface

### Banding Ideas



Left to right:

**Light Grey:** Blue Reflective Band  
**Sandstone:** Red/White Reflective Band  
**Black:** Yellow Reflective Band

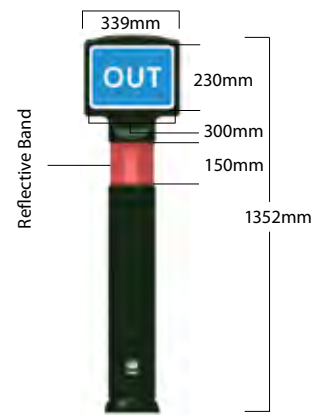

### Specification

Weight: Less than 7kg  
Material: MDPE

All dimensions and weights are nominal

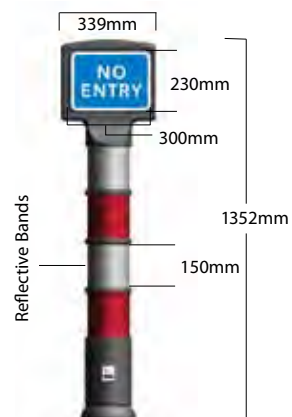

### Specification

Weight: Less than 7kg  
Material: MDPE

All dimensions and weights are nominal



# Roadside Storage Bins & Sentry Sign

Ideal for a wide range of situations and applications



**Above:** Grit Bins used in car parks for staff and customer safety.

**Left:** Grit Bins can be produced in a range of colours and with personalisation.

**Right:** In storage 200 litre Grit Bins can be stacked five high.

**Far right:** Sentry Signs provide robust and useful advisory signage for garage forecourts.







## Salt & Grit Bins

- Double skin perimeter lid for greater rigidity
- Robust rib structure for added strength
- Wear resistant base
- 200 litre units nest up to five high, 400 litre units nest up to four high (180 degree, 60% nest for a stable stack)
- Fork lift space for easy manoeuvrability

### Capacity

200 & 400 litre capacity

### Optional

- Hasp and Staple
- Gold Banding
- Personalisation

### Colours (see page 23)

Standard & Premium

200 litres

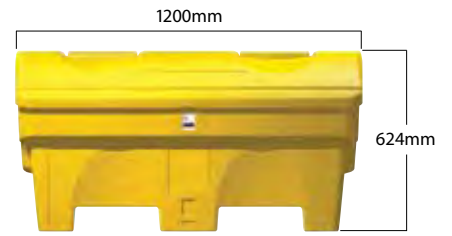

400 litres



All dimensions are nominal

## Sentry Sign & Barrier

- Temporary vehicular and pedestrian warning sign
- Use in multiples to form barriers
- Stackable, practical for large events
- Robust, durable & impact resistant
- Weather resistant
- Choice of screw fixings or channel for slot-in graphic board\*

\*Not included

### Colours (see page 23)

Standard & Premium

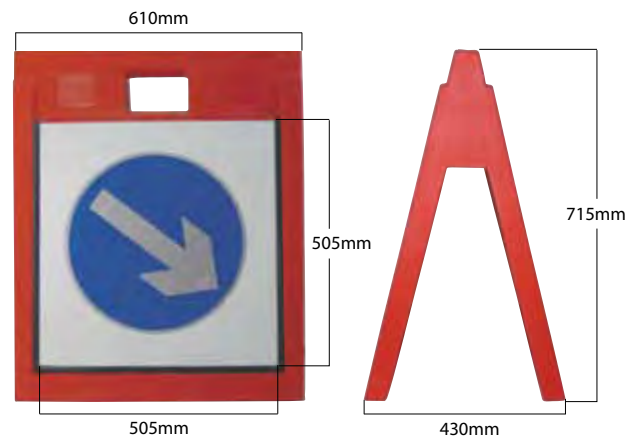

### Specification

Weight: 7 kg

Material: MDPE

All dimensions and weights are nominal





# Bollard Product Selector

Scale  
1 m



Version		150	150	Deco	150	150	Deco	MANCHESTER	150	Visibol	150
Type		Visibol			Visibol						
Dimensions (mm)	Height	1024	1024	921	1030	1030	926	1010	1125	1125	1084
	Diameter	171	171	171	166	166	166	201	166	166	185
Material Options	Standard	✓	✓	✓	✓	✓	✓	✓	✓	✓	✓
	Reflex	✓	-	✓	✓	-	✓	✓	✓	-	✓
	*ECO	✓	✓	✓	✓	✓	✓	✓	✓	✓	-
Fixing Options	PM Permanent	✓	✓	✓	✓	✓	✓	✓	✓	✓	✓
	S Socketed	✓	✓	✓	✓	✓	✓	✓	✓	✓	✓
	AR Anti-ram	✓	✓	✓	✓	✓	✓	✓	✓	✓	✓
	SM Surface	✓	✓	✓	✓	✓	✓	✓	✓	✓	✓
Signage Options	Class ref 1	✓	✓	-	✓	✓	-	✓	✓	✓	✓
	Class ref 2	✓	✓	-	✓	✓	-	✓	✓	✓	✓
	Decorative band	✓	✓	✓	-	-	✓	✓	✓	✓	-
DDA Compliant		✓	✓	-	✓	✓	-	-	✓	✓	✓

## Fixing options

### Permanent Fixing (PM)

For permanent fixing the bollard base is concreted in below ground. The bollard is supplied as a single unit with a moulded-in anchor section that is set into the concrete ensuring that the bollard cannot be removed.



### Anti-Ram Fixing (AR)

The bollard is supplied as a 'sleeve' that sits over a robust steel tube core that is permanently concreted into the ground. Effective as a deterrent only to 'ram raiding' (not PAS 68 classified) and also enhances pedestrian safety within high risk areas.



### Socketed Fixing (S)















This two piece system allows the bollard to be quickly removed to allow immediate access or replacement. The bollard comes with a moulded-in 'bayonet' end that fixes (by rotating through 90 degrees) into a lockable base unit that has been set in concrete below ground level. A blanking cap is available for when the bollard is removed. Where reflex material is specified the product is only suitable for very low speed impacts.



### Surface Fixing (SM)

The bollard is supplied with an integral circular base with four bolt holes for quick and easy fixing onto a suitable concrete base. Ideal in a wide range of situations and particularly suitable for multi-storey car parks, bridges and any situation where below ground services or membranes might be vulnerable. Where reflex material is specified the product is only suitable for very low speed impacts. \* ECO version not available



URN			REGENCY			EDGE MINDER	MONARCH	STERLING	VERGEMARKER II	LINSIGN 300				LINSIGN 230		
																
75	150	Deco					Heritage	Heritage	Sentinel	Sentinel	Heritage	Heritage	Sentinel			
							Visibol			Visibol	Visibol					
1009	1030	910	510	800	800	938	1419	1419	1419	1419	1352	1352	1352			
185	166	166	130	170	170	125	364	364	364	364	339	339	339			
✓	✓	✓	✓	✓	✓	-	✓	✓	✓	✓	✓	✓	✓			
✓	✓	✓	✓	✓	✓	✓	-	-	-	-	-	-	-			
-	-	-	✓	-	-	-	✓	✓	✓	✓	✓	✓	✓			
✓	✓	✓	✓	✓	✓	✓	✓	✓	✓	✓	✓	✓	✓			
✓	✓	✓	-	-	-	-	✓	✓	✓	✓	✓	✓	✓			
✓	✓	-	-	✓	✓	-	✓	✓	✓	✓	✓	✓	✓			
✓	✓	✓	-	-	-	-	✓	✓	✓	✓	✓	✓	✓			
✓	✓	-	✓	✓	-	-	✓	✓	✓	✓	✓	✓	✓			
✓	✓	-	✓	-	-	✓	✓	✓	✓	✓	✓	✓	✓			
-	-	✓	✓	-	-	-	✓	✓	-	-	✓	✓	-			
-	✓	-	-	-	-	-	✓	✓	✓	✓	✓	✓	✓			

## Material options

### Reflex (Self Righting)

Reflex bollards are manufactured from a tough and durable material, which enables the products to withstand impact from any direction and return to an upright position and continue in service.

Specify Reflex material for vulnerable locations where conventional bollards would otherwise require frequent replacement.

Where reflex material is specified with either a Socketed or Surface Fixing the product is only suitable for very low speed impacts.



### ECO

ECO bollards are manufactured using a combination of 50% chipped plastic bottles and 50% regular polymer. Using chipped material reduces the environmental impact of re-processing to the absolute minimum.

ECO bollards are available in black or an attractive stone effect finish which, due to the nature of the material, will vary slightly.

### Standard

Standard Moulded Polyethylene (PE) is extremely durable with outstanding impact, fracture and shatter resistance properties tested to BS2782. PE is also 100% recyclable allowing the material to be reused at the end of the bollard in-service life.





# LINSIGN 150

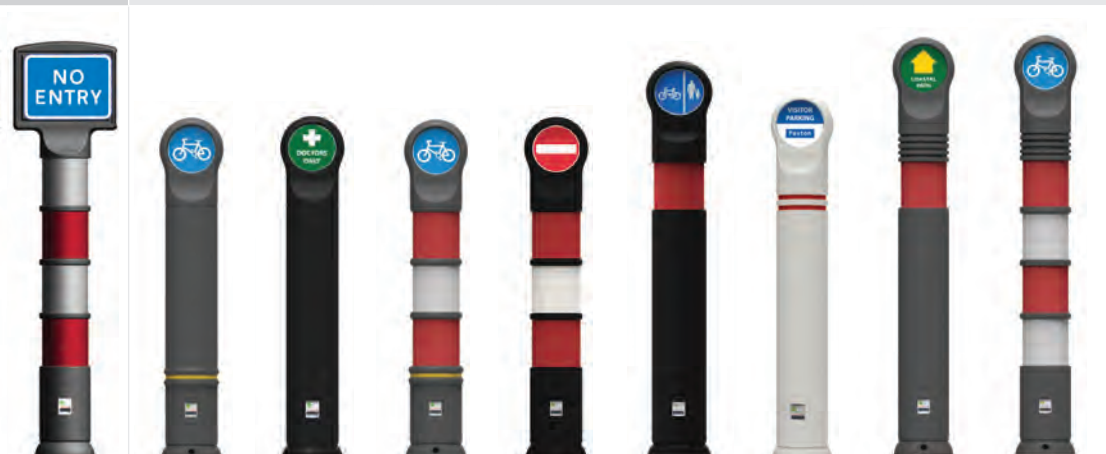

This is a summary, please refer to the product brochure for full details on all options available.

Version	Type	Height	Dimensions (mm)
Sentinel	Visibol	1352	339
Heritage	Visibol	1098	195
Sentinel	Visibol	1098	195
Heritage	Visibol	1098	195
Sentinel	Visibol	1098	195
Sentinel	Decorative	1300	195
Sentinel	Decorative	1196	195
Sentry	Visibol	1376	195
Sentry	Visibol	1376	195
		Standard	Material Options
		Reflex	Material Options
		ECO*	Material Options
		PM Permanent	Fixing Options
		S Socketed	Fixing Options
		AR Anti-ram	Fixing Options
		SM Surface	Fixing Options
		Class ref 1	Signage Options
		Class ref 2	Signage Options
		Decorative band	Signage Options
			DDA Compliant

## Reflective Banding

### Class ref 1 Engineering Grade

**Applications:** Non Highway traffic signs, emblems, street name plates and other general signage.

**Benefits:** Provides good level of reflective performance, appearing both bright and legible in daylight and at night.

7 year effective performance life.



### Class ref 2 High Intensity

**Applications:** Highway traffic safety applications where night time visibility is paramount.

**Benefits:** Provides high level of reflective performance. Class 2 material is approximately 3.5 times brighter than Class 1 material and provides a 10 year effective performance life.



Aluminium backed British Standard Reflective Banding (BS EN 12899-1 2001)

Decorative/Non-reflective gold/silver banding  
personalised sign faces and bands available

## Decorative Banding

Gold and Silver metallic decorative banding is available as a standard optional extra to add a stylish and traditional look particularly in heritage or prestige environments. If there is a special requirement to use coloured or reflective material on the decorative band this may also be possible by quotation subject to quantities and lead times.





# Night Owl



Type		Illuminated	Non-illuminated
Dimensions (mm)	Height	1037	1037
	Width / Depth	395 / 110	395 / 110
	Sign face	300 dia	300 dia
	Base	320 x 320	320 x 320
Material		One piece reflex/rigid polymer composite	Reflex base, rigid polymer bollard
Passively safe	PM Permanent	BS EN 12767:2007 100 NE4.	BS EN 12767:2007 100 NE4.
Conspicuity	Type	Fluorescent translucent retroreflective to BS 5740	Fluorescent retroreflective to BS 5740
	Area front	0.16m <sup>2</sup>	0.16m <sup>2</sup>
	Area side	0.045m <sup>2</sup>	0.045m <sup>2</sup>
Lighting	Source	Cree LED powered by Zeta 240V - 6.65 Watts Circuit power factor 6.4	
	Photocell	55 Lux, Switching ratio:0.5 Typical burn hours 4115	
UMSUG	Charge code	40 0007 0006 100	
Fixing		Attach to in-ground Duct Box Retrofit to other base boxes with adapter plates	Concrete-in Surface mount



## Night Owl™

All plastic, recyclable, passively safe, self-righting 'Keep Left' bollards that minimise the consequences of collisions for the driver and reduce the cost of repair and maintenance for the authority.

Available in both illuminated and non-illuminated formats, Night Owl has passed BS EN 12767:2007 & BS 8442:2006, 'Retro Reflective Self Righting Bollards' which require products to remain intact, returning to an upright position after a high speed impact, without reducing the speed of the vehicle by more than 3km/h.

Night Owl has particular application as a Keep Left bollard providing a durable, low maintenance, energy efficient, reduced carbon footprint solution for traffic islands in general.

See the Night Owl brochures for detailed information.

Night Owl is a Trademark of Leaffield Environmental Ltd



# Heritage

Traditional style... choice of options...  
suitable for urban and rural environments.

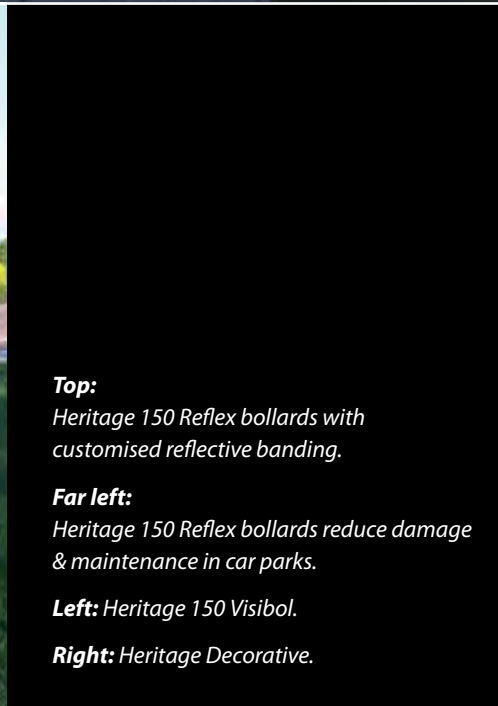

**Top:**  
*Heritage 150 Reflex bollards with  
customised reflective banding.*

**Far left:**  
*Heritage 150 Reflex bollards reduce damage  
& maintenance in car parks.*

**Left:** *Heritage 150 Visibol.*

**Right:** *Heritage Decorative.*





## Heritage 150

✓ DDA   
 ✓ ECO   
 ✓ REFLEX   
 ✓ Class ref 1&2

### Choose from

Heritage 150 Standard  
 Heritage 150 Reflex  
 Heritage 150 ECO

### Fixing Options\*

Heritage 150 Standard                      All  
 Heritage 150 Reflex                          PM, S & SM  
 Heritage 150 ECO                              PM, AR & S

### Colours (see page 23)

Standard & Premium  
 Reflex or ECO

### Banding

Choice of Class ref 1 & Class ref 2 British  
 Standard Reflective banding available.  
 Aluminium backed for vandal resistance.  
 Decorative banding is optional see page 13.

\*PM - Permanent, AR - Anti-Ram, S - Socketed, SM - Surface

### Banding Ideas



Left to right:

**Light Grey:** Blue Reflective Band,  
Blue Decorative Band  
**Burgundy:** Yellow Reflective Band  
**Racing Green:** Yellow Reflective Band,  
Gold Decorative Band  
**Sandstone:** Red/White Reflective Band

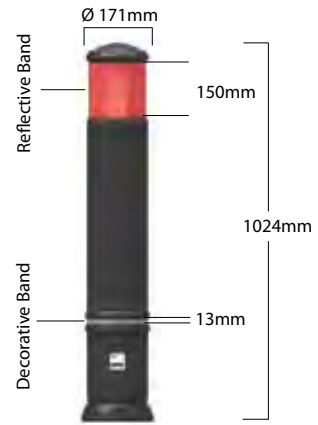

### Specification

Weight: Less than 7kg  
 Material: MDPE

All dimensions and weights are nominal

## Heritage 150 Visibol

✓ DDA   
 ✓ ECO   
 ✓ Class ref 1&2

### Choose from

Heritage 150 Visibol Standard  
 Heritage 150 Visibol ECO

### Fixing Options\*

Heritage 150 Visibol Standard                      All  
 Heritage 150 Visibol ECO                              PM, AR & S

### Colours (see page 23)

Standard & Premium  
 ECO

### Banding

Choice of Class ref 1 & Class ref 2 British  
 Standard Reflective banding available.  
 Aluminium backed for vandal resistance.  
 Decorative banding is optional see page 13.

\*PM - Permanent, AR - Anti-Ram, S - Socketed, SM - Surface

### Banding Ideas



Left to right:

**Light Grey:** Blue Cycle Reflective Band,  
Blue Decorative Band  
**Black:** Yellow Reflective Band  
**Black:** All Yellow Reflective  
& Decorative Band  
**Sandstone:** Red/White Reflective Band

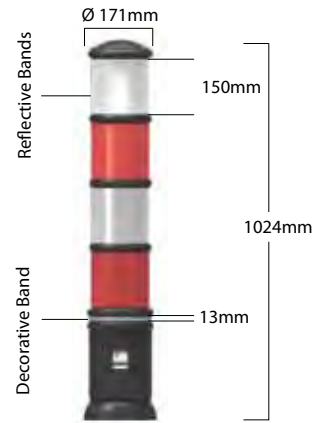

### Specification

Weight: Less than 7kg  
 Material: MDPE

All dimensions and weights are nominal



## Heritage Decorative

✓ ECO   
 ✓ REFLEX

### Choose from

Heritage Decorative Standard  
 Heritage Decorative Reflex  
 Heritage Decorative ECO

### Fixing Options\*

Heritage Decorative Standard                      All  
 Heritage Decorative Reflex                          PM & SM  
 Heritage Decorative ECO                              PM, AR & S

### Colours (see page 23)

Standard & Premium  
 Reflex  
 ECO

### Banding

Choice of Decorative banding available.  
 See page 13.

\*PM - Permanent, AR - Anti-Ram, S - Socketed, SM - Surface

### Banding Ideas



Left to right:

**Light Grey:** Blue Decorative Band  
Gold Decorative Band  
**Burgundy:** Gold Decorative Band  
**Racing Green:** Gold Decorative Band  
**Sandstone:** Red Reflective Band

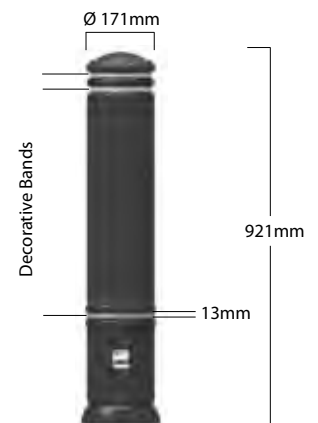

### Specification

Weight: Less than 6kg  
 Material: MDPE

All dimensions and weights are nominal



# Regency & Woburn

Traditional profiles... modern material... practical choice.

CASTLE COMBE  
GIDDEA HALL  
SLAUGHTERFORD  
BATH  
CORSHAM



Woburn 75 bollards with reflective banding



Regency Decorative bollard

## Woburn 75

### Choose from

Woburn 75 Standard  
Woburn 75 Reflex

### Fixing Options\*

Woburn 75 Standard  
Woburn 75 Reflex

All  
PM & SM

### Colours (see page 23)

Standard & Premium  
Reflex

### Branding

Choice of Class ref 1 & Class ref 2 British  
Standard Reflective banding available.  
Aluminium backed for vandal resistance.  
See page 13.

### Banding Ideas



Left to right:

Light Grey: Blue Reflective Band

Black: Yellow Reflective Band

Racing Green: Yellow Reflective Band

Sandstone: Red/White Reflective Band

\*PM - Permanent, AR - Anti-Ram, S - Socketed, SM - Surface





# Regency 150

✓ DDA    ✓ REFLEX    ✓ Class ref 1&2

**Choose from**  
 Regency 150 Standard  
 Regency 150 Reflex

**Fixing Options\***  
 Regency 150 Standard  
 Regency 150 Reflex

All  
 PM & SM

**Colours** (see page 23)  
 Standard & Premium  
 Reflex

**Banding**  
 Choice of Class ref 1 & Class ref 2 British  
 Standard Reflective banding available.  
 Aluminium backed for vandal resistance.  
 See page 13.

\*PM - Permanent, AR - Anti-Ram, S - Socketed, SM - Surface

## Banding Ideas



Left to right:  
**Light Grey:** Blue Cycle Reflective Band  
**Black:** Yellow Reflective Band  
**Burgundy:** Yellow Reflective Band  
**Slate Mottle Grey:** Red/White Reflective Band



## Specification

Weight: Less than 6kg  
 Material: MDPE  
 All dimensions and weights are nominal

# Regency Decorative

✓ REFLEX

**Choose from**  
 Regency Decorative Standard  
 Regency Decorative Reflex

**Fixing Options\***  
 Regency Decorative Standard    PM, S & SM  
 Regency Decorative Reflex    PM & SM

**Colours** (see page 23)  
 Standard & Premium  
 Reflex

**Banding**  
 Choice of Decorative banding available.  
 See page 13.

\*PM - Permanent, AR - Anti-Ram, S - Socketed, SM - Surface

## Banding Ideas

Metallic



Left to right:  
**Light Grey:** Blue Decorative Band  
**Black:** Silver Decorative Band  
**Burgundy:** Gold Decorative Band  
**Slate Mottle Grey:** Red Decorative Band

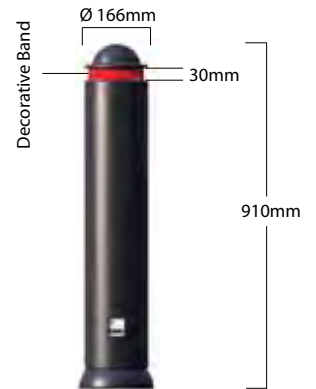

## Specification

Weight: Less than 6kg  
 Material: MDPE  
 All dimensions and weights are nominal

✓ REFLEX    ✓ Class ref 1&2

# Woburn 150

✓ DDA    ✓ REFLEX    ✓ Class ref 1&2

**Choose from**  
 Woburn 150 Standard  
 Woburn 150 Reflex

**Fixing Options\***  
 Woburn 150 Standard  
 Woburn 150 Reflex

All  
 PM & SM

**Colours** (see page 23)  
 Standard & Premium  
 Reflex

**Banding**  
 Choice of Class ref 1 & Class ref 2 British  
 Standard Reflective banding available.  
 Aluminium backed for vandal resistance.  
 See page 13.

\*PM - Permanent, AR - Anti-Ram, S - Socketed, SM - Surface

## Banding Ideas



Left to right:  
**Light Grey:** Blue Cycle Reflective Band  
**Burgundy:** Yellow Reflective Band  
**Racing Green:** Yellow Reflective Band  
**Sandstone:** Red/White Reflective Band

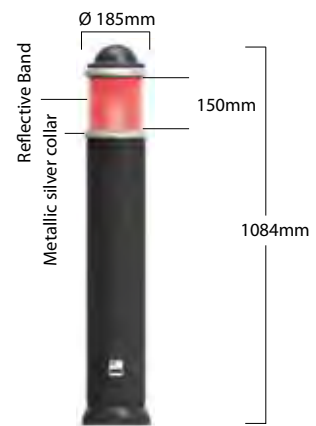

## Specification

Weight: Less than 7.5kg  
 Material: MDPE  
 All dimensions and weights are nominal

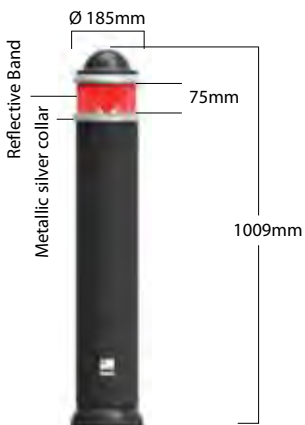

## Specification

Weight: Less than 7.5kg  
 Material: MDPE  
 All dimensions and weights are nominal

# Sentinel Bollards

Contemporary style... durable & practical...  
ideal for urban, retail and industrial locations.

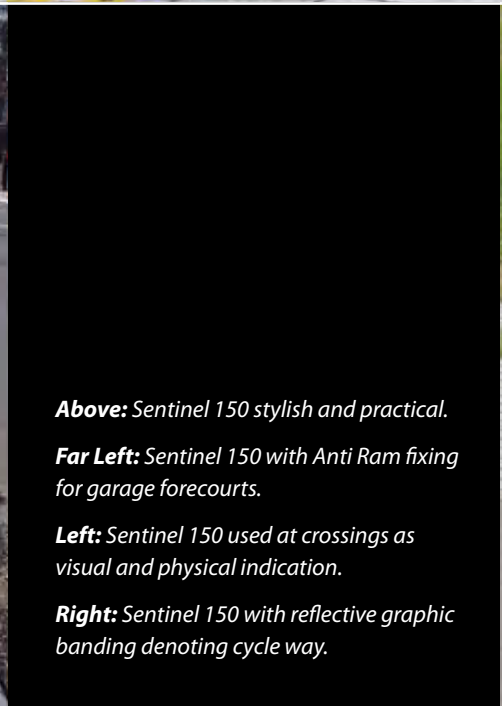

**Above:** Sentinel 150 stylish and practical.

**Far Left:** Sentinel 150 with Anti Ram fixing for garage forecourts.

**Left:** Sentinel 150 used at crossings as visual and physical indication.

**Right:** Sentinel 150 with reflective graphic banding denoting cycle way.





## Sentinel 150

✓  
DDA
✓  
ECO
✓  
REFLEX
✓  
Class ref 1&2

### Choose from

Sentinel 150 Standard  
 Sentinel 150 Reflex  
 Sentinel 150 ECO

### Fixing Options\*

Sentinel 150 Standard All  
 Sentinel 150 Reflex PM, S, & SM  
 Sentinel 150 ECO PM, AR & S

### Colours (see page 23)

Standard & Premium  
Reflex or ECO

### Banding

Choice of Class ref 1 & Class ref 2 British  
 Standard Reflective banding available.  
 Aluminium backed for vandal resistance.  
 See page 13.

\*PM - Permanent, AR - Anti-Ram, S - Socketed, SM - Surface

### Banding Ideas



Left to right:

**Light Grey:** Blue Cycle Reflective Band  
**Black:** Yellow Reflective Band  
**Racing Green:** Yellow Reflective Band  
**Sandstone:** Red/White Reflective Band

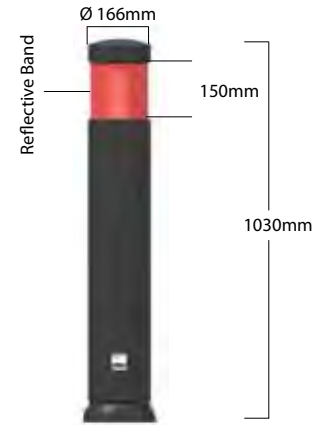

### Specification

Weight: Less than 7kg  
 Material: MDPE

All dimensions and weights are nominal

## Sentinel 150 Visibol

✓  
DDA
✓  
ECO
✓  
Class ref 1&2

### Choose from

Sentinel 150 Visibol Standard  
 Sentinel 150 Visibol ECO

### Fixing Options\*

Sentinel 150 Visibol Standard All  
 Sentinel 150 Visibol ECO PM, AR & S

### Colours (see page 23)

Standard & Premium  
ECO

### Banding

Choice of Class ref 1 & Class ref 2 British  
 Standard Reflective banding available.  
 Aluminium backed for vandal resistance.  
 See page 13.

\*PM - Permanent, AR - Anti-Ram, S - Socketed, SM - Surface

### Banding Ideas



Left to right:

**Light Grey:** Blue Cycle Reflective Band  
**Black:** All yellow Reflective Band  
**Black:** Yellow Reflective Band  
**Sandstone:** Red/White Reflective Band

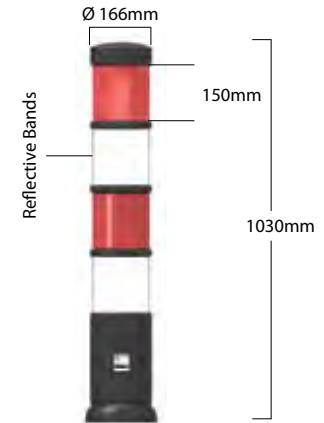

### Specification

Weight: Less than 7kg  
 Material: MDPE

All dimensions and weights are nominal



## Sentinel Decorative

✓  
ECO
✓  
REFLEX

### Choose from

Sentinel Decorative Standard  
 Sentinel Decorative Reflex  
 Sentinel Decorative ECO

### Fixing Options\*

Sentinel Decorative Standard All  
 Sentinel Decorative Reflex PM & SM  
 Sentinel Decorative ECO PM, AR & S

### Colours (see page 23)

Standard & Premium  
 Reflex  
 ECO

### Banding

Choice of Decorative banding available.  
 See page 13.

\*PM - Permanent, AR - Anti-Ram, S - Socketed, SM - Surface

### Banding Ideas



Left to right:

**Light Grey:** Blue Decorative Band  
**Burgundy:** Gold Decorative Band  
**Racing Green:** Gold Decorative Band  
**Sandstone:** Red Decorative Band

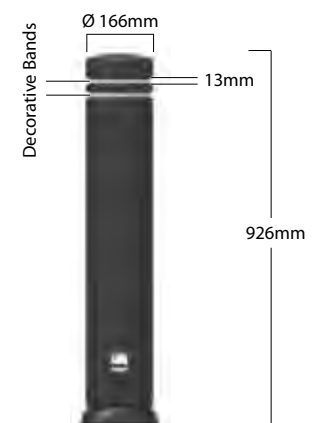

### Specification

Weight: Less than 6kg  
 Material: MDPE

All dimensions and weights are nominal



# Bollards for Town and Country

... designs to suit a range of applications.



**Above:**  
Edgeminder bollards used to protect grass verges.

**Left:** Sterling bollards used with chain link, supplied by customer.

**Right:** Monarch bollards used to protect an office building.





# Monarch

## Choose from

Monarch Standard  
Monarch Reflex

## Fixing Options\*

Standard  
Reflex

PM & AR  
PM

## Colours (see page 23)

Standard & Premium  
Reflex

## Banding

Choice of Class ref 1 British Standard  
Reflective banding available. See page 13.

\*PM - Permanent, AR - Anti-Ram, S - Socketed, SM - Surface

REFLEX Class ref 1

## Banding Ideas



Left to right:

Pallet Orange: Red Reflective Band  
Signal Red: Yellow Reflective Band  
Racing Green: Yellow Reflective Band  
Golden Yellow: Red Reflective Band

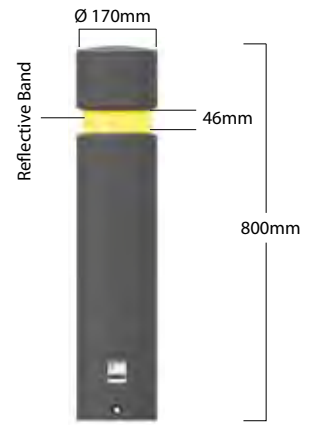

## Specification

Weight: Less than 3.5kg  
Material: MDPE

All dimensions and weights are nominal

# Edgeminder

## Choose from

Edgeminder Standard  
Edgeminder Reflex  
Edgeminder ECO

## Fixing Options\*

Standard  
Reflex  
ECO

PM  
PM  
PM

## Colours (see page 23)

Standard & Premium  
Reflex or ECO

## Banding

Choice of Class ref 1 & Class ref 2 British  
Standard Reflective banding available.  
Aluminium backed for vandal resistance.  
Decorative banding is optional see page 13.

\*PM - Permanent, AR - Anti-Ram, S - Socketed, SM - Surface

ECO REFLEX Class ref 1&2

## Banding Ideas



Left to right:

Light Grey: Blue Reflective Band  
Burgundy: Gold Reflective Band  
Racing Green: Silver Reflective Band  
Sandstone: Red Reflective Band

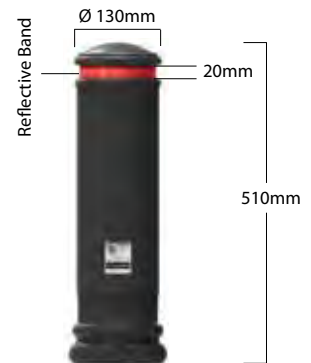

## Specification

Weight: Less than 1.75kg  
Material: MDPE

All dimensions and weights are nominal



# Sterling

## Choose from

Sterling Standard  
Sterling Reflex

## Fixing Options\*

Standard  
Reflex

PM & AR  
PM

## Colours (see page 23)

Standard & Premium  
Reflex



REFLEX

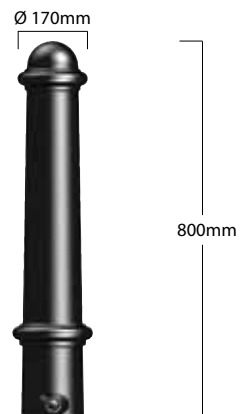

## Specification

Weight: Less than 5kg  
Material: MDPE

All dimensions and weights are nominal

\*PM - Permanent, AR - Anti-Ram, S - Socketed, SM - Surface



# Vergemarker

High on practicality and visibility...  
low on maintenance and cost.



## Colours

Leafield manufactures all its products to order, so it is often possible to match your colour scheme or other specifications.

Please call our Customer Services Team to discuss your requirements.



# Vergemarkers provide a high visibility warning sign and are particularly effective in a range of high risk incident situations including deceptive bends and junctions.

Vergemarkers are manufactured as a single unit and have a moulded-in below ground section to allow for permanent fixing. They are produced in very strong reflex material and the overall product design provides low impact resistance to vehicles.

If struck by a vehicle Vergemarker is designed to fold at a specific crease point without unduly reducing the vehicle speed. Unobstructed they will self right to an upright position to continue in service.

The reflector is a Class 2 retro-reflective material on a stainless steel backing for improved adhesion and durability.

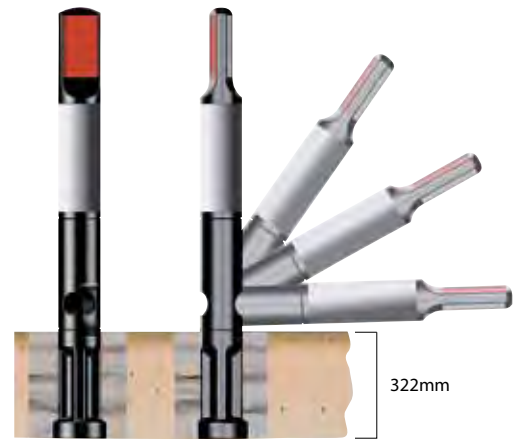

## Vergemarker



- Choose from**  
Reflex Vergemarker
- Fixing Options\***  
Reflex Vergemarker
- Colours** (see page 23)  
Black
- Banding**  
White band as standard.

\*PM - Permanent

✓ REFLEX    ✓ Class ref 2

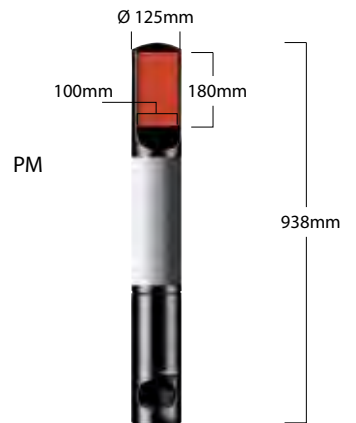

### Specification

Weight: Less than 1.9kg  
Material: MDPE

All dimensions and weights are nominal

### Standard



### Premium

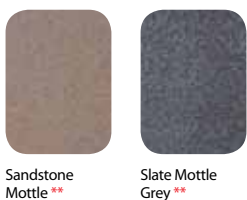

### Reflex

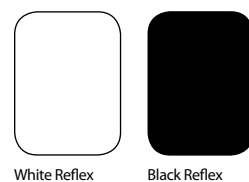

### ECO



The colours reproduced in this brochure are constrained by the printing process. Colour plaques are available on request if required.

\* Denotes a colour with a longer lead time  
\*\* Denotes a colour with a premium price point

# About Leaffield Environmental

We are an award winning UK manufacturer and a specialist producer of solutions for the needs of the Litter, Recycling, Highways, Water, and Agricultural markets.

Our customers include the country's leading Companies, Universities and Public Sector institutions.

## Environmental - ISO 14001

We are a company that cares about the environment and our business has in place Environmental Management Systems that have been certified and comply with BS EN ISO 14001:2004.

## Quality & Service - ISO 9001

We have a 'quality culture' running throughout our business and have systems in place, certified to BS EN ISO 9001:2008, which ensure that our customers receive a consistently high level of quality and service.

## Health & Safety

We care about the occupational Health and Safety of our staff and are an OHSAS 18001 certified employer.

## Registered Designs

Vergemarker, Sentinel 150, Night Owl and Night Owl Base are the Registered Designs of Leaffield Environmental.

## Sustainability

Our products are principally manufactured using Medium Density Polyethylene (MDPE) which is 100% recyclable at the end of the product in-service life. Wherever possible our products are made using a proportion of recycled material that varies according to product type and colour.

## Award Winning Design

Our design team consistently produce product solutions that are independently recognised for their excellence.

2003	Best Environmental or Energy Efficiency Programme	Envirobank 140
2003	National Recycling Awards Recycled product of the year finalist	Envirobank 140
2008	Best Industrial Product Design	TwinBin
2008	Technical Innovation Award	WT Drinking Troughs
2010	Horners Award for Plastic Design & Innovation (Highly Commended Certificate)	Night Owl Keep Left Bollard

Leaffield Environmental is setting new standards in the design, manufacture and performance of a range of specialist products for the Highways market.

From the exciting new Night Owl Keep Left bollard with its high passive safety rating and our range of Reflex or 'bounce back' bollards to our ECO products that utilise recycled plastic bottles, Leaffield Environmental's innovative, solutions led approach is clearly apparent.

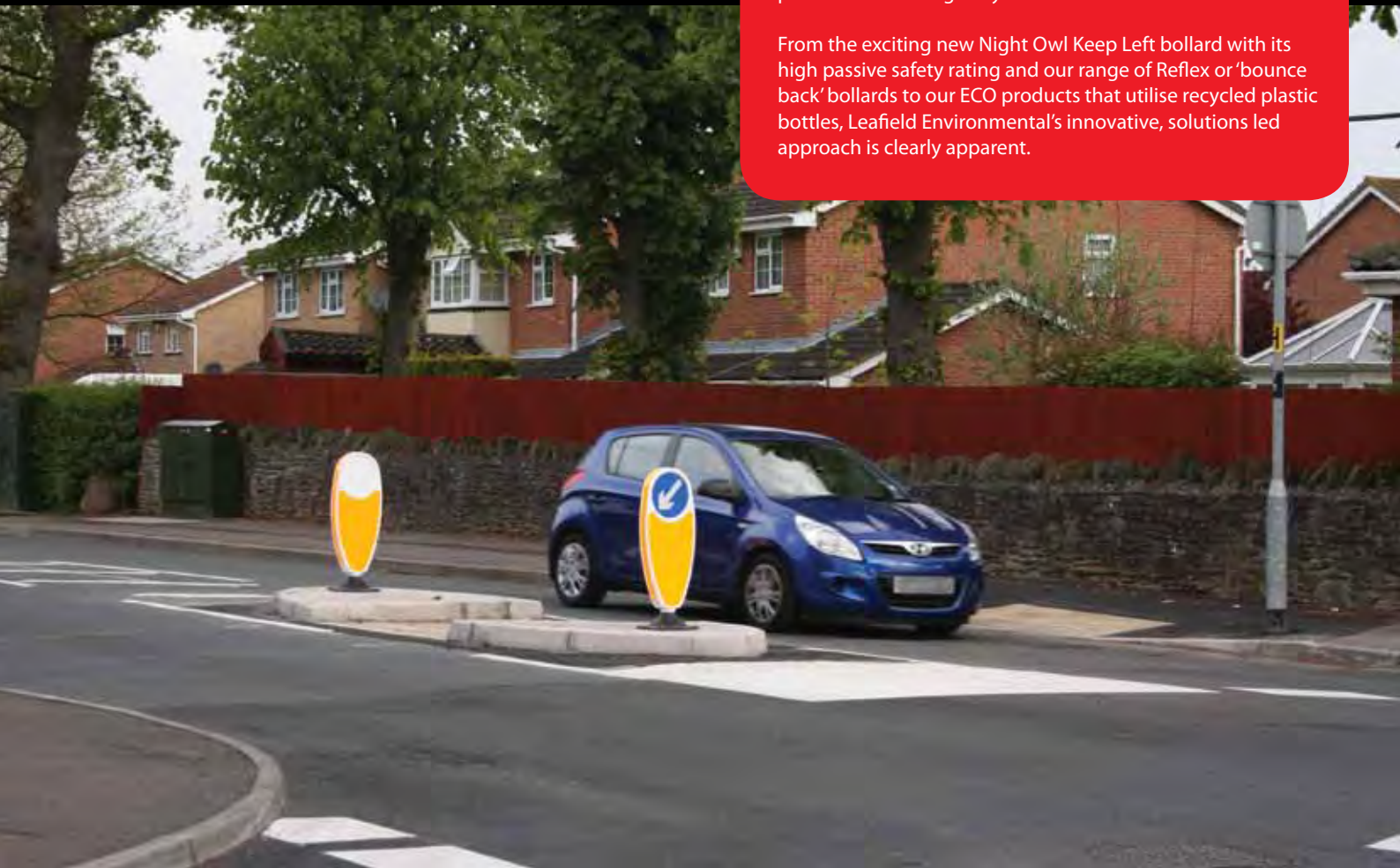

Tel: 01189 404717  
Fax: 01189 403216  
[www.streetfurnishings.co.uk](http://www.streetfurnishings.co.uk)