

EVEREDGE BASIC INSTALLATION GUIDELINES

EverEdge has many applications and installation WILL DIFFER depending on SOIL CONDITIONS and EXPECTED WEAR
Correct and careful installation is essential for both AESTHETIC VALUE and SAFETY

! KEEP OUT OF REACH OF CHILDREN

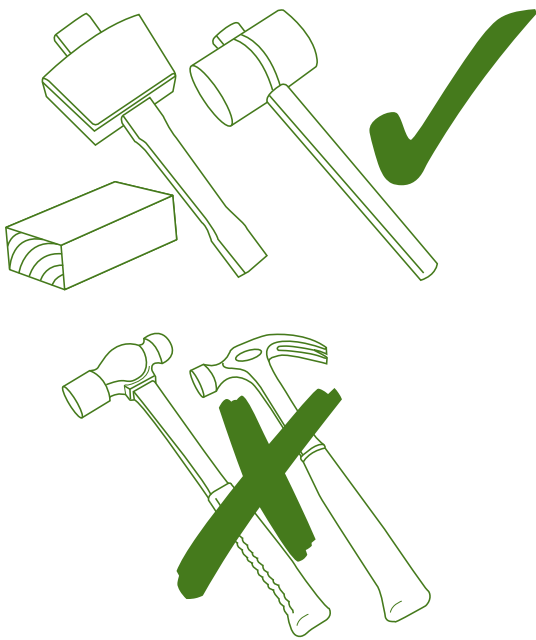

NOTE: Wherever possible overlap EverEdge. If EverEdge must be cut it is advisable to paint the bare edges with good quality primer to prevent rust

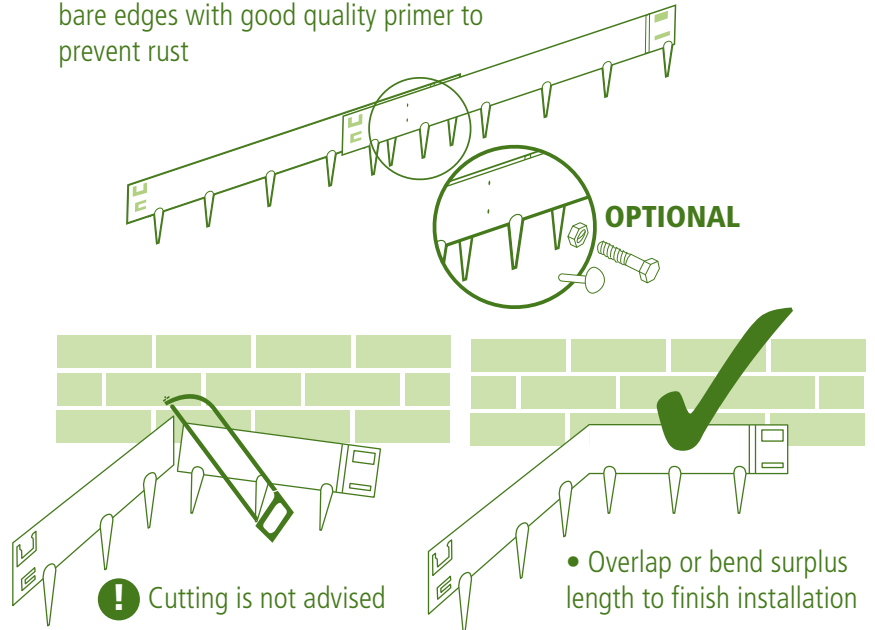

1 Prepare a line for the edging to follow and remove any obstructions. If ground is stony, loosen with pickaxe

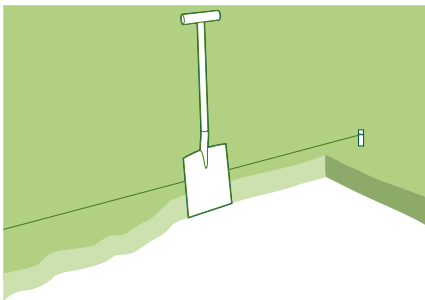

2 Drive one end of EverEdge to correct depth, leaving other end sufficiently clear to enable linking to next section

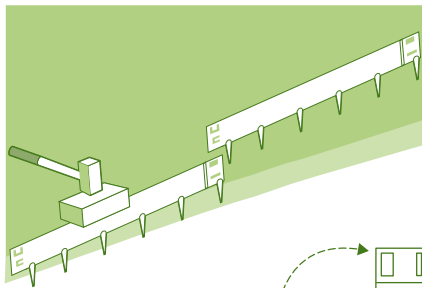

3 The top of the EverEdge panel should be level with the point where the soil and grass meet

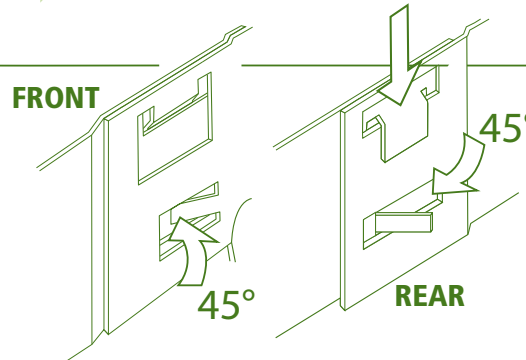
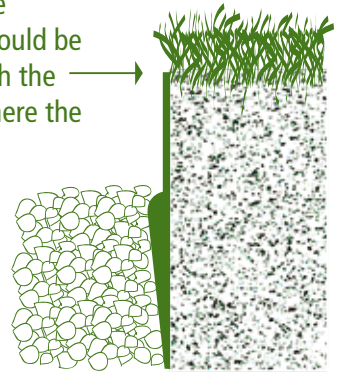

4 Link the EverEdge and use a screwdriver to push the tongue on the front panel through the hole in the rear panel no more than 45°

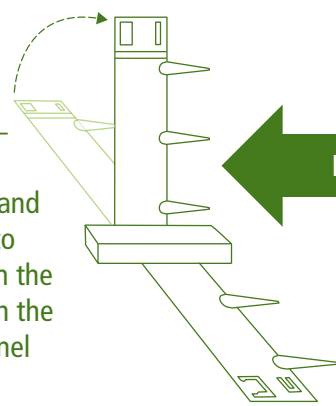

BENDING EVEREDGE
A work bench, the edge of a table, a timber, or other former is advised when bending EverEdge to required angle