



Tree Tying Systems Selection Chart

shaping your environment

TYPE OF TREE	PROTECTION AGAINST			
	HEIGHT RANGE (METERS)	GIRTH RANGE (CENTIMETERS)	WIND	VANDALISM & MAINTENANCE
TRANSPLANTS & WHIPS	< 1.25	< 3.5	NO	SYSTEM A
ROOT BALL TRANSPLANTS & WHIPS	< 1.5	< 4	SYSTEM B	SYSTEM B
WHIPS, QUARTER STANDARDS & HALF STANDARDS	1.5 TO 3.0	4 TO 12	SYSTEM A	SYSTEM C
STANDARDS & FEATHERED	> 3.0	>12	SYSTEM D	SYSTEM E

Buckle Tree Tie

Sofftee Tree Tie

Tree Cushion

Tree Block

Easy Fix Strapping

Chainlock

Jumbo Spacer



Tree Tying Systems

SYSTEM A

GENERAL DESCRIPTION

This is the simplest and lowest cost system (fig1) used primarily when a tree is at least 1.5 meters above ground level in an area that may be exposed to windy conditions and where the tree is planted with no root ball, usually bare root. The stake needs to stand 1/3 of the tree height above the ground and have about the same depth under the ground and preferably of a rigid construction of a section 22 x 22 or 25 x 25 mm square.

A standard tree tie such as a Buckle Tree Tie (fig5) is preferable but also a Softee type tree tie (fig6) can be used in a more domestic situation. The Buckle Type Tree Tie is preferable due to the high strength capability of the centre of the Buckle which has to carry quite high tensile loads as the tree develops in windy conditions through the summer months. The tree tie needs to be at least 45 cm (18 inches) in length to allow it to accommodate a cushioning device, such as the included collar (fig4), between the stake and the tree (fig2) and to allow for a good fastening and adjustment ability.

The Tree Tie needs to be positioned 20 mm ($\frac{3}{4}$ inch) below the top of the stake (fig3) so as to prevent the possibility of the tree rubbing against the stake in windy conditions.

The Tree Tie should be inspected annually and adjusted if necessary to prevent the Tie damaging the young tree bark should it become over tightened or slipping in any way. The Tree Tie should be removed after 3 years to allow the tree to develop further.

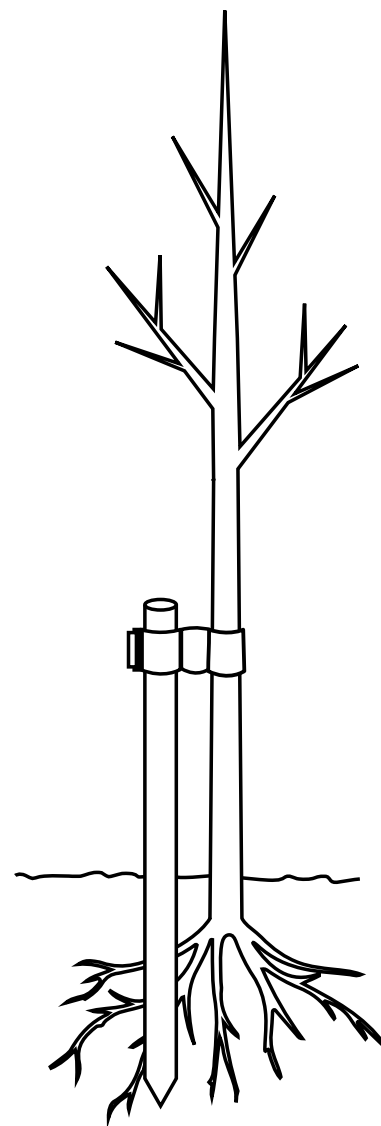

Fig 1

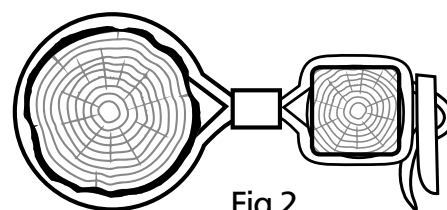

Fig 2

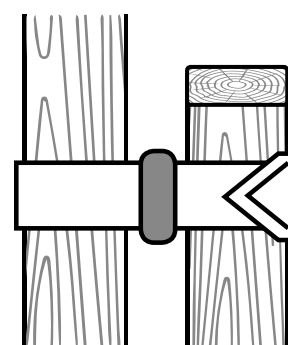

Fig 3



INSTRUCTIONS

1) Position the stake in the ground so as to allow the stake to be above the ground level at 1/3 the height of the tree and towards the prevalent wind direction from the desired position of the tree. Check the stake is firmly in position and offers a very solid and stable fixing point for the tree.

2) The Tree should now be planted 75 mm (3 inches) from the stake in the desired position and well-heeled in with firm surface soil conditions to protect the growing tree roots from too much disturbance.

3) Thread the collar (fig4) once along the Buckle Tree Tie strap (fig5) and position the Buckle on the opposite face of the stake to the tree. Holding the protective collar on the strap between the tree and the stake wrap the tree tie strap once around the tree until it comes back towards the protective collar and thread it again through the protective collar. Now we continue the strap into the Buckle and thread it through ensuring the strap enters the Buckle from the flat side of the Buckle as opposed to the side with the leading point on.

4) The Tree Tie can now be positioned on the tree stake and tree around 20 mm ($\frac{3}{4}$ inch) below the top (fig3) of the stake and firmly tightened so as to prevent it slipping or allowing the tree to rub inside the tree tie strap or against the top of the stake. The shape we are making with the tree tie is that of a figure '8' (fig2) with the open buckle side to the ground stake and the closed loop around the tree with the spacing collar between the stake and tree.

5) Should it be needed you can fasten the tree tie to the stake using a flat headed galvanised clout or roofing nail making sure the nail is fixed on the first side of the strap and stake (fig2) so not preventing further adjustment later on leaving the last side of the strap that entered the Buckle free for the adjustment. This reduces the possibility of the tree tie sliding on the stake either way but is usually unnecessary if the Tree Tie has been correctly tightened.

6) The Buckle Type Tree Tie does have some protection for the tree in the design in that under high tensile loads from the growing tree the Buckle can slide slightly on the strap and the Collars do open up slightly, enough to enable one year's tree growth.

7) Should a One Piece moulding type of tree tie be preferred such as a Softee Tree Tie (fig6) it does need to be at least 40 cm (15 $\frac{3}{4}$ inches) long. The tree tie is then positioned around the outside of the tree with the castellated part of the strap to the tree bark to reduce the risk of bark damage. The tree tie is then passed through itself between the tree and stake and pulled to be taught around the tree and the cross over in the strap positioned between the tree and stake. Finally the tree tie can now be interlocked on the outer face of the stake (fig7) away from the tree.

8) It is recommended that newly planted trees of this size should have some sort of weed control of at least $\frac{1}{2}$ square meter around the tree.



Fig 4 Collars /Spacers



Fig 5 Buckle Tree Ties

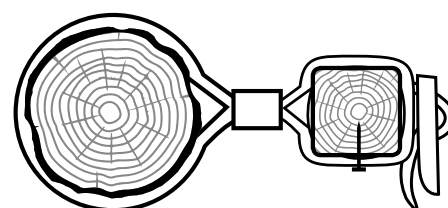

Fig 2



Fig 6 Softee Tree Ties

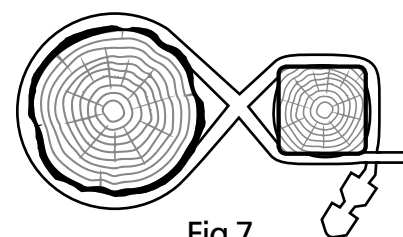

Fig 7



SYSTEM B

GENERAL DESCRIPTION

This system is where a new tree is being planted with its root ball and is at least 1.5 meters above ground level in an area that may be exposed to windy conditions (fig8). Here the stake must not pass through the root ball and therefore must be driven into the ground at an angle of around 30 degrees to the tree so as to cross the tree at about of 1/3 of the total height of the tree and be in the ground outside of the root ball but as close as possible. The stake therefore needs to be around 105 cm long and of at least a 25 x 25 mm section for a typical root ball for a tree this size of under 30 cm diameter with half the stake being above ground and half beneath. Should the tree be planted on a slope then the stake should always be placed in the ground directly up the slope from the tree and still at a 30 degree angle to the tree but a shorter stake can be used in this instance.

A standard tree tie such as a Buckle Tree Tie (fig5) is preferable for this type of application. The Buckle Type Tree Tie is preferable due to the high strength capability of the centre of the Buckle which has to carry quite high tensile loads as the tree develops in windy conditions through the summer months. The tree tie needs to be at least 45 cm (18 inches) in length to allow it to accommodate a cushioning device (fig4) between the stake and the tree and allow for a good fastening and adjustment ability.

The Tree Tie needs to be positioned where the tree is nearest to the stake and preferably quite close to the top of the stake so as to prevent the possibility of the tree rubbing against the stake in windy conditions.

The Tree Tie should be inspected annually and adjusted if necessary to prevent the Tie damaging the young tree bark should it become over tightened or slipping in any way. The Tree Tie should be removed after 3 years to allow the tree to develop further.

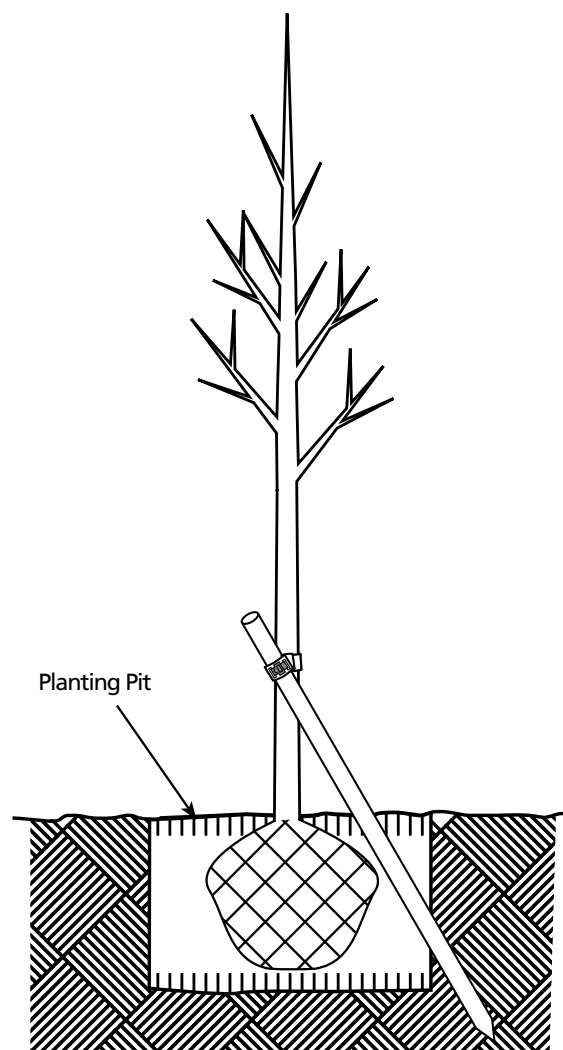

Fig 8

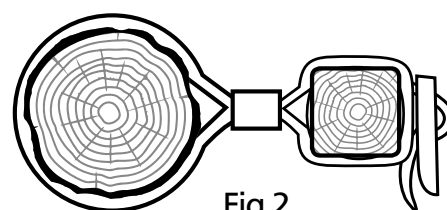

Fig 2

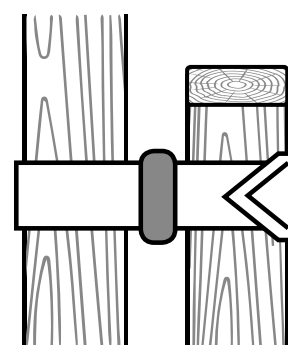

Fig 3



INSTRUCTIONS

1) Position the stake in the ground so as to allow the stake to be above the ground level at 1/3 the height of the tree and towards the prevalent wind direction from the desired position of the tree. Should the tree be on a sloping surface position the stake up the slope from where the tree centre is required. Check the stake is firmly in position and offers a very solid and stable fixing point for the tree.

2) The Tree should now be planted in a suitably dug hole which can fully accommodate the root ball and well-heeled in with firm surface soil conditions to protect the growing tree roots from too much disturbance.

3) Thread the collar (fig4) once along the Buckle Tree Tie strap (fig5) and position the Buckle on the opposite face of the stake to the tree. Holding the protective collar on the strap between the tree and the stake wrap the tree tie strap once around the tree until it comes back towards the protective collar and thread it again through the protective collar. Now we continue the strap into the Buckle and thread it through ensuring the strap enters the Buckle from the flat side of the Buckle as opposed to the side with the leading point on.

4) The Tree Tie (fig5) can now be positioned around the tree stake and tree and firmly tightened so as to prevent it slipping or allowing the tree to rub inside the tree tie strap or against the top of the stake. The shape we are making with the tree tie is that of a figure '8' (fig2) with the open buckle side to the ground stake and the closed loop around the tree with the spacing collar between the stake and tree (fig3).

5) Should it be needed you can fasten the Buckle Tree Tie (fig5) to the stake using a flat headed galvanised clout or roofing nail making sure the nail is fixed on the first side of the strap and stake (fig2) so not preventing further adjustment later on, leaving the last side of the strap that entered the Buckle free for the adjustment. This reduces the possibility of the tree tie sliding on the stake either way but is usually unnecessary if the Tree Tie has been correctly tightened.

6) The Buckle Type Tree Tie does have some protection for the tree in the design in that under high tensile loads from the growing tree the Buckle can slide slightly on the strap and the Collars do open up slightly, enough to enable one year's tree growth.

7) It is recommended that newly planted trees of this size should have some sort of weed control for at least 1/2 square meter around the tree.



Fig 4 Collars /Spacers



Fig 5 Buckle Tree Ties

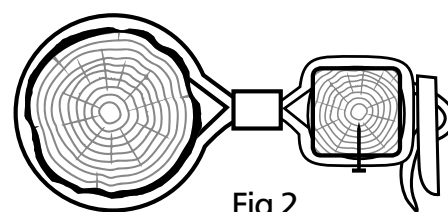

Fig 2

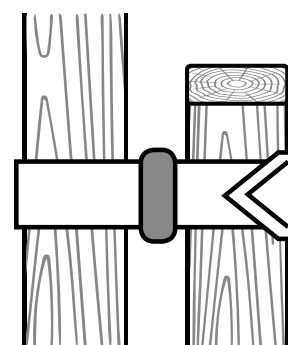

Fig 3



SYSTEM C

GENERAL DESCRIPTION

This system is typically used on trees being planted with a root ball and having a stem length above ground level of not more than 1 meter which suggests a total tree height of 3 meters (fig9). We use two stakes which need to be at least 50 mm (2 inches) diameter and these need to stand 1/3 of the tree height above ground level and at least half of this height below ground so typically a 3 meter high tree would have 1 meter of stake above ground and 0.5 meters into the ground to gain a firm anchorage. The two stakes are placed in a line in the direction of the prevalent wind direction and at least 75 mm (3 inches) clear of the root ball on both sides. A 60 mm (2½ inches) wide cross bar is then attached to the stakes permanently which will provide a flat piece of rigid support directly above where our tree will be about 1/3 of the way up the tree.

The key issue with this design is that we need the tree to be held very firmly in the bottom third to prevent any possibility of movement of the root ball or rocking which would damage the newly formed root hairs on the outside of the root ball. A method of preventing the tree from rubbing or moving against our cross bar is required such as a soft Rubber Cushion (fig13) or Rubber Tree Block (fig14) and the tree must be held firmly against our rubber cushion usually by a Buckle Tree Tie (fig5) which passes around the tree and through the rubber block or cushion and preferably through our cross bar (fig10). The Buckle Tree Tie allows some adjustment on future inspections as opposed to using a length of strapping which is nailed to the cross bar with galvanised flat headed nails but this is much harder to adjust should it be required. The fixing strapping that is nailed to the cross bar would ideally be the Easy Fix (fig12) type with pre formed reinforced nail holes in it to remove the danger of the strap breaking under load around the fixing nail holes. Ideally the Rubber Tree Cushion or Rubber Tree Block should have a fixing nail to attach it to the cross bar making sure the nail head cannot come in contact with our newly planted tree (fig11).

This tree tying assembly should be inspected annually and adjusted if necessary to prevent any damage to the young tree bark should it become over tightened or slipping in any way. The tree tie should be removed after 3 years to allow the tree to develop further.

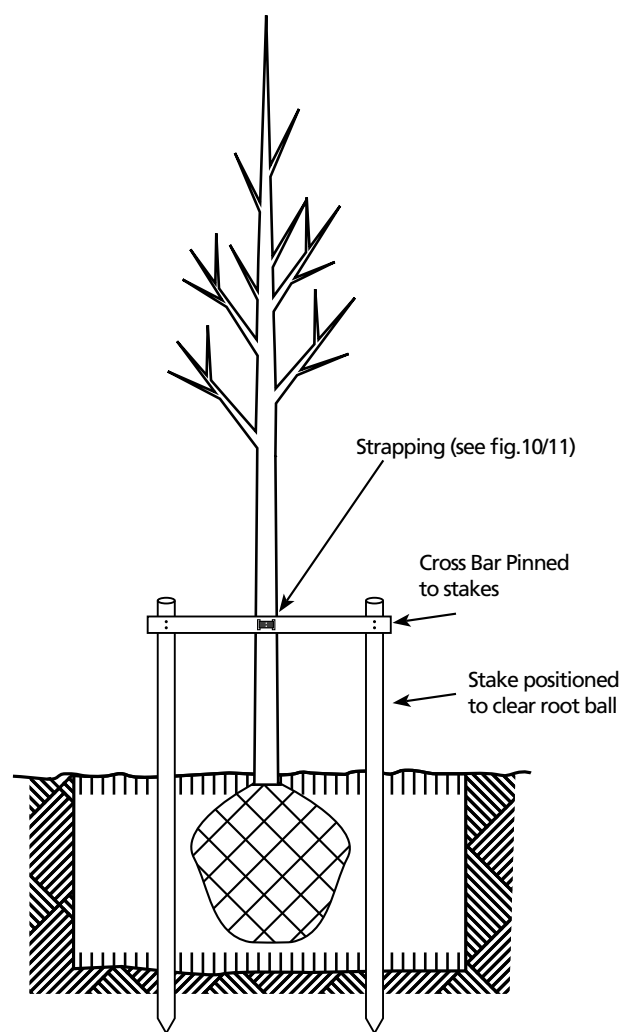

Fig 9

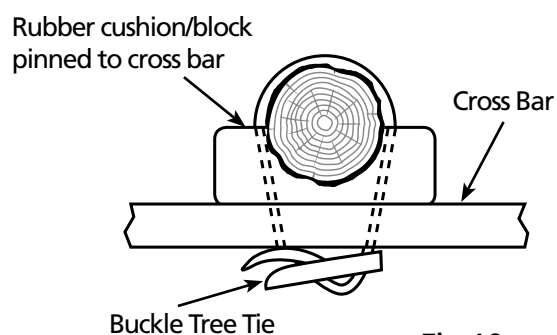

Fig 10

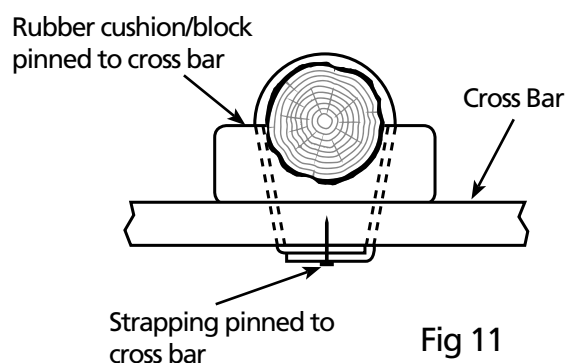

Fig 11



INSTRUCTIONS

1) Position the stakes vertically in good solid ground at least 75 mm (3 inches) outside of our tree pit hole we have made to safely accommodate our root ball. The tree stakes which should be at least 50 mm (2 inches) in diameter need to stand at least 1/3 of the way up our tree and have at least 1/2 as much again to be under the ground level to provide us with a good firm anchorage point. The two tree stakes should be equidistant from the tree centre spot and be in a line of the prevalent wind direction. A cross bar can now be fixed firmly across our two ground stakes which needs to provide us with a firm flat surface of at least 60 mm (2½ inches) directly above the centre of the tree, as this needs to provide a good firm anchorage point for our tree it should be at least 18 mm (¾ inch) thick. The cross bar should have two slots or holes in it to allow the fixing strap to come through it matching the strap slots in the Rubber Tree Cushion/ Rubber Tree Block.

2) The tree with its root ball should now be positioned in our tree pit so the tree stem runs neatly across the face of the cross bar in a central position and the root ball back filled with good firm growing medium.

3) Position a good firm 25 mm (1 inch) size Rubber Tree Cushion (fig13) or Rubber Tree Block (fig14) between the tree stem and the cross bar and fix the Cushion/Block to the cross bar with a single flat headed galvanised clout or roofing nail in a position where the tree stem cannot come into contact with it which is usually at the top and inside the Rubber Tree Cushion or in a pre-formed hole in the Rubber Tree Block.

4) A 25 mm (1 inch) Buckle Tree Tie (fig5) can now be threaded from the back of our cross bar through one slot in the cross bar and through one slot in the Rubber Tree Cushion/ Blocks. Then pass the strap around the tree making sure the strap runs horizontally around the tree so the top and bottom edges of the strap will not rub into the tree. The strap can then continue through the opposite slot in the Rubber Tree Cushion/Block and cross bar and then threaded through the Buckle on the back side of the cross bar and then pulled tight to hold the tree firmly against the cross bar with the cushion held snugly between them. We do offer standard cross bars with the required slots in to accommodate the 25 mm strapping in a central position to match standard Cushions and Blocks. A 25 mm (1 inch) hole drilled through the cross bar to match the two slots in the Rubber Tree Cushion/Block will suffice. A 25 mm (1 inch) plain tree strap can be used instead of a Buckle Tree Tie but this does not allow for any further adjustment as the tree grows. We recommend using 25 mm Easy Fix Strapping (fig12) in this instance which has pre formed and reinforced holes in it to accommodate the fixing nails which are fixed in the back of the cross bar and are less likely to break the strap around the nail holes with the varying tensile loads applied to the strap by the growing tree.

5) It is recommended that newly planted trees of this size should have some sort of weed control of at least 1 square meter around the tree.



Fig 5 Buckle Tree Ties



Fig 12 Easy Fix Strapping



Fig 13 Rubber Tree Cushion



Fig 14 Rubber Tree Block



SYSTEM D

GENERAL DESCRIPTION

This system is for trees usually at least 3.2 meters in height and planted in rural areas where the newly planted tree has a stem length greater than 1.1 meters (3½ feet). It is most important the root ball is held very firmly and the stem does not bend just above the root ball or flexes underneath a single tree tie. We therefore need two levels of tree tying (fig15) in such applications where the two levels actually offer different types of support that the young tree needs for its best development. The highest tree tie point comes at the usual 1/3 of tree height and here the tree needs some slight movement in the stem in order to allow the tree to develop its own resistance to wind loading. When the tree tie system is removed the tree can continue to grow and be resistant to wind loading. We need a further lower tree tie now which stops the lower part of the stem from moving as the upper tree sways slightly in windy conditions. The tree tie above the root ball prevents any movement at all to protect these initially fragile root hairs where most of the trees nourishment is coming from and future anchoring strength. As these trees come under higher wind load conditions we need two stakes and to cover all potential wind directions.

The assembly here has a wider range of potential sizes so we need to use a strapping on a roll and cut to the desired length system which will be nailed to the stakes and offers resistance to more than one direction. We suggest a flexible system for the top tree tie which is the Easy Flex Strapping (fig17) which is a 38 mm (1¾ inches) strapping with the pre formed and reinforced nail holes which allows some movement for the developing tree stem fixed between two strong round tree stakes and Jumbo Spacers (fig18) or Collars (fig4) which reduce movement of the tree too much in any direction. We copy the same design for the lower tree tie but here we need 38 mm or 1¾ inches Easy Fix Strapping which does not allow any stretch so as to keep the root ball firmly fixed in position again using Jumbo Spacers or Collars to prevent the tree stem moving from wind in any direction here.

The Top Tree Strapping needs to be positioned 1/3 of the way up the tree and 20 mm (¾ inch) below the top of the stake so as to prevent the possibility of the tree rubbing against the stake in windy conditions. The lower tree strap needs to be positioned halfway between the top strapping level and ground level.

The tree straps should be inspected annually and adjusted if necessary to prevent the straps damaging the young tree bark should it become over tightened or slipping in any way. The tree straps should be removed after 3 years to allow the tree to develop further.

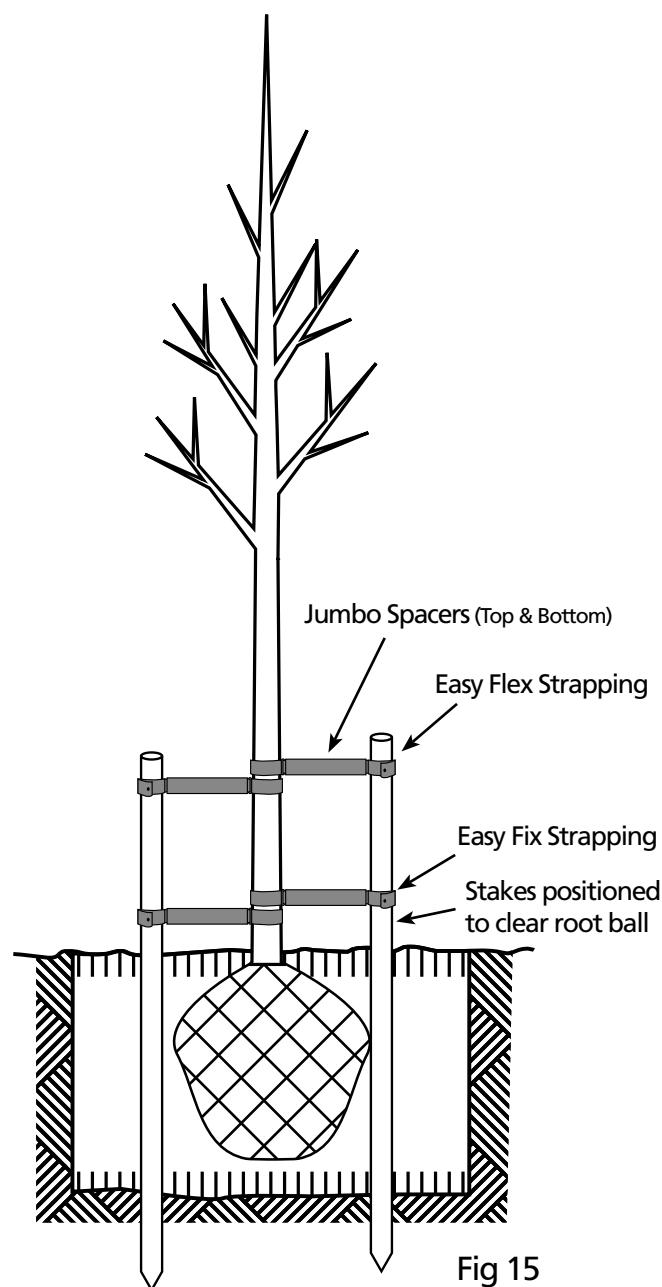

Fig 15

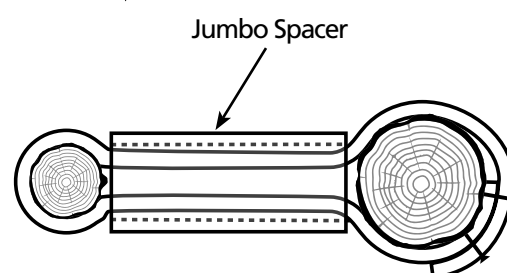

Fig 16



INSTRUCTIONS

1) Position the stakes vertically in good solid ground at least 100 mms (4 inches) outside of our tree pit hole we have made to safely accommodate our root ball. The tree stakes which should be at least 75 mm (3 inches) in diameter need to stand at least 1/3 of the way up our tree and have at least 1/2 as much again under the ground level to provide us with a good firm anchorage point. The two tree stakes should be equidistant from the tree centre spot and be in a line of the prevalent wind direction.

2) The tree with its root ball should now be positioned in our tree pit so the tree stem runs in a central position, between the stakes and the root ball back filled with good firm growing medium.

3) We suggest making the top strapping assembly first by using 38 mm (1 3/4 inches) Easy Flex Strapping (fig17) which will allow the top of the tree stem some slight flexibility to allow the tree to develop its own resistance to wind loadings and reduce the risk of wind damage to the stem once the tying system has been removed. This top strapping needs to be positioned about 25 mm (1 inch) below the top of the fixing stakes and we need to form a figure '8' shape (fig16) between each of the two stakes and the tree separately by passing the Easy Flex Strapping around the tree then both ends of the strap through a Jumbo Spacer (fig18) cut to the required length which is the distance between the stake and the tree less 100 mm (4 inches). We then continue with the straps out of the Spacer and then around the outside of the tree stake and fix the strap to the outside of the stake using two flat head galvanised clout or roofing nails making sure they both go through both ends of the strap (fig16) and through one of the pre formed and reinforced nail holes. Repeat this process for the opposite side top strapping position, again using the more flexible Easy Flex Strapping, making sure the tree is held firmly in position by these two straps once the top assembly has been completed. We can now complete the assembly repeating this process for the lower strapping at a height halfway between the top strapping level and ground level but using the 38 mm (1 3/4 inches) Easy Fix Strapping (fig12) product to provide a very stable lower stem to protect the root ball effectively.

4) This assembly can also be carried out using a Chainlock type of strapping (fig20) where a 25 mm (1 inch) Chainlock 5 product is used instead of the Easy Fix, Easy Flex and Jumbo Spacers. The Chainlock 5 strapping is interlocked on itself around the tree and then interlocked again on itself at a length that matches the distance between the stake and tree and then interlocked on itself again tightly around the stake. We do recommend fixing the Chainlock 5 against the outside of the stakes using flat headed galvanized clout or roofing nail tightly in a corner of one of the central slots to prevent the Chainlock 5 from working its way down the stakes under the constant movement of the tree.

5) It is recommended that newly planted trees of this size should have some sort of weed control of at least 1 square meter around the tree.

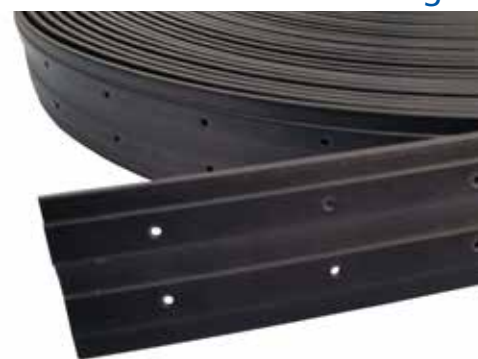

Fig 17 Easy Flex Strapping



Fig 18 Jumbo Spacers



Fig 12 Easy Fix Strapping



Fig 20 Chainlock 5



SYSTEM E

GENERAL DESCRIPTION

This system is for trees usually at least 3.2 meters in height and planted in urban areas which are subject not just to wind loads but potentially accidental damage from pedestrians, vandalism and maintenance work (fig19). As the trees will have a stem length greater than 1.1 meters (3½ feet) it is most important the root ball is held very firmly and the stem does not bend just above the root ball or flexes underneath a single tree tie. We therefore need two levels of tree tying in such applications where the two levels actually offer different types of support that the young tree needs for its best development. The highest tree tie point comes at the usual 1/3 of tree height and here the tree needs some slight movement in the stem in order to allow the tree to develop its own resistance to wind loading so when the tree tie system is removed the tree can continue to grow and be resistant to wind loading. We need a further lower tree tie now which stops the lower part of the stem from moving as the upper tree sways slightly in windy conditions. The tree tie above the root ball prevents any movement at all to protect these initially fragile root hairs where most of the trees nourishment is coming from and future anchoring strength. To prevent the possibility of accidental damage to the tree stem we need to surround it by three strong stakes so passing traffic will not be able to rub against the tree stem without first hitting one of the stakes.

The assembly here has a wider range of potential sizes so we need to use a strapping on a roll and cut to the desired length which will be nailed to the stakes and offers resistance to more than one direction. We suggest a flexible system for the top tree tie which is the Easy Flex Strapping (fig12) which is a 38 mm (1¾ inches) strapping with the pre formed and reinforced nail holes which allows some movement for the developing tree stem fixed between three strong round tree stakes and Jumbo Tree Spacers (fig16) or Collars (fig4) which reduce movement of the tree too much in any direction. We copy the same design for the lower tree tie but here we need 38 mm (1¾ inches) Easy Fix Strapping (fig17) which does not allow any stretch so as to keep the root ball firmly fixed in position again using Jumbo Tree Spacers or Collars to prevent the tree stem moving from wind in any direction here.

The top tree strapping needs to be positioned 1/3 of the way up the tree and 20 mms (¾ inch) below the top of the stake so as to prevent the possibility of the tree rubbing against the stake in windy conditions. The lower tree strap needs to be positioned halfway between the top strapping level and ground level.

The tree straps should be inspected annually and adjusted if necessary to prevent the straps damaging the young tree bark should it become over tightened or slipping in any way. The tree straps should be removed after 3 years to allow the tree to develop further.

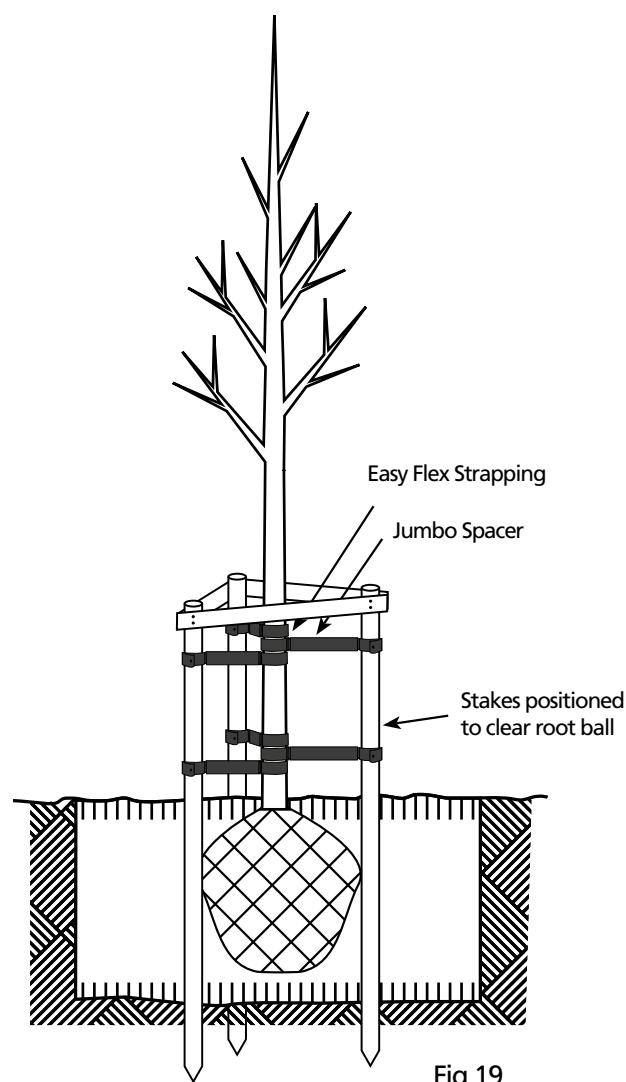

Fig 19

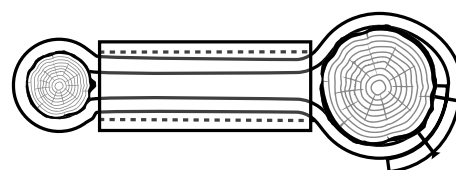

Fig 16



INSTRUCTIONS

1) Position three stakes, equidistant apart (fig19), vertically in good solid ground at least 100 mms or 4 inches outside of our tree pit hole we have made to safely accommodate our root ball. The tree stakes which should be at least 75 mm (3 inches) in diameter need to stand at least 1/3 of the way up our tree and have at least 1/2 as much again to be under the ground level to provide us with a good firm anchorage point. One of the three stakes should be positioned in a line from the centre of the tree into the prevalent wind direction. A cross bracing system near the top of the three stakes will increase the strength of the staking structure which is desirable.

2) The tree with its root ball should now be positioned in our tree pit so the tree stem runs in a central position, between the stakes and the root ball back filled with good firm growing medium.

3) We suggest making the top strapping assembly first by using 38 mm (1 $\frac{3}{4}$ inches) Easy Flex Strapping (fig17) which will allow the top of the tree stem some slight flexibility to allow the tree to develop its own resistance to wind loadings and reduce the risk of wind damage to the stem once the tying system has been removed. This top strapping needs to be positioned about 25 mm (1 inch) below the top of the fixing stakes and we need to form a figure '8' shape between each of the two stakes and the tree separately by passing the Easy Flex strapping around the tree then both ends of the strap through a Jumbo Spacer (fig18) cut to the required length which is the distance between the stake and the tree less 100 mm (4 inches). We then continue with the straps out of the Spacer and then around the outside of the tree stake and fix the strap to the outside of the stake using two flat head galvanised clout or roofing nails making sure they both go through both ends of the strap and through one of the pre formed and reinforced nail holes (fig16). Repeat this process for the remaining further two stakes top strapping position, again using the more flexible Easy Flex Strapping, making sure the tree is held firmly in position by these three straps once the top assembly has been completed. We can now complete the assembly repeating this process for the lower strapping at a height halfway between the top strapping level and ground level but using the 38 mm (1 $\frac{3}{4}$ inches) Easy Fix Strapping (fig12) product to provide a very stable lower stem to protect the root ball effectively.

4) This assembly can be carried out using a Chainlock type of strapping (fig20) where a 25 mm (1 inch) Chainlock 5 product (fig20) is used instead of the Easy Fix, Easy Flex and Jumbo Spacers where the Chainlock 5 strapping is interlocked on itself around the tree and then interlocked again on itself at a length that matches the distance between the stake and tree and then interlocked on itself again tightly around the stake. We do recommend fixing the Chainlock 5 against the outside of the stakes using a flat head galvanised clout or roofing nail tightly in a corner of one of the central slots to prevent the Chainlock 5 from working its way down the stakes under the constant movement of the tree. We would again recommend that the Chainlock 5 strapping be placed both at a top point and a mid-way point to try and stop the stem from bending low down which could rock the root ball or damage some of the very fine root hairs which are growing.

5) It is recommended that newly planted trees of this size should have some sort of weed control of at least 1 square meter around the tree.

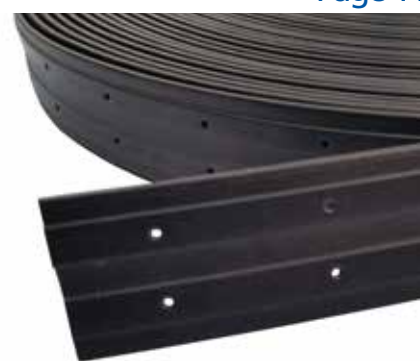

Fig 17 Easy Flex Strapping



Fig 18 Jumbo Spacers

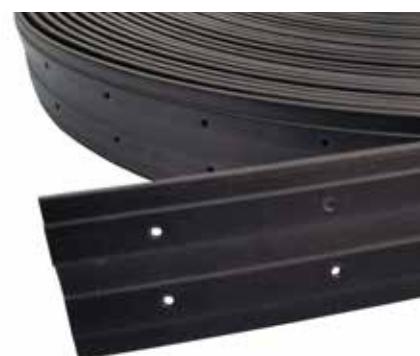
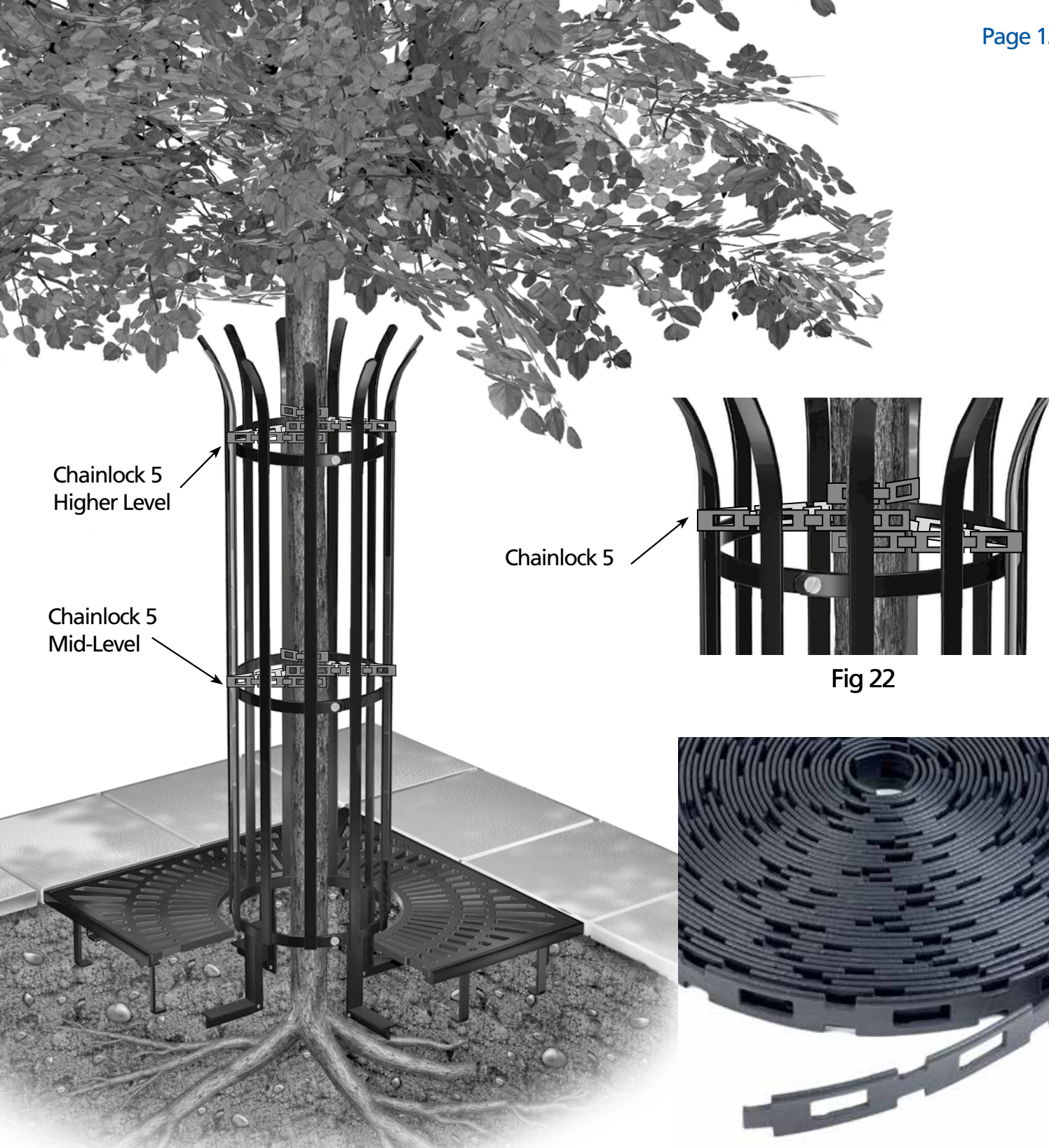

Fig 12 Easy Fix Strapping



Fig 20 Chainlock 5





Chainlock 5
Higher Level

Chainlock 5
Mid-Level

Chainlock 5

Fig 22

Fig 21 Metal Tree Protector (with Grille)

Fig 20 Chainlock 5

METAL TREE PROTECTORS

We recommend that the System E with Chainlock 5 (fig20) is always used for a Metal Tree Protector (fig21) installation where the stakes can be replaced by the Steel Protector itself. We recommend a three tie system (fig22) as with system E and at the higher and mid-levels making sure the Chainlock 5 Strapping is wrapped around a vertical and horizontal member of the Tree Protector to prevent it moving under the constantly variable loads on the tree.

(for identification purposes only Chainlock 5 has been shown in white on this information sheet)

