

Springers

J3603



2+



2



0,5m



1 = 1,57m 2 = 0,43m 3 = 0,72m

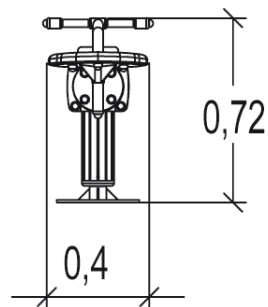
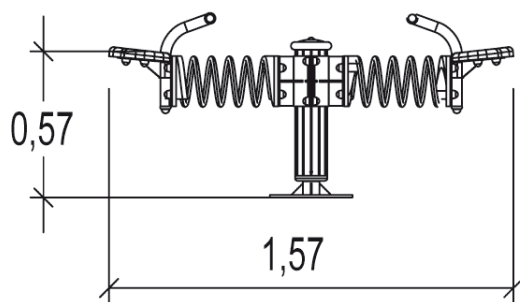
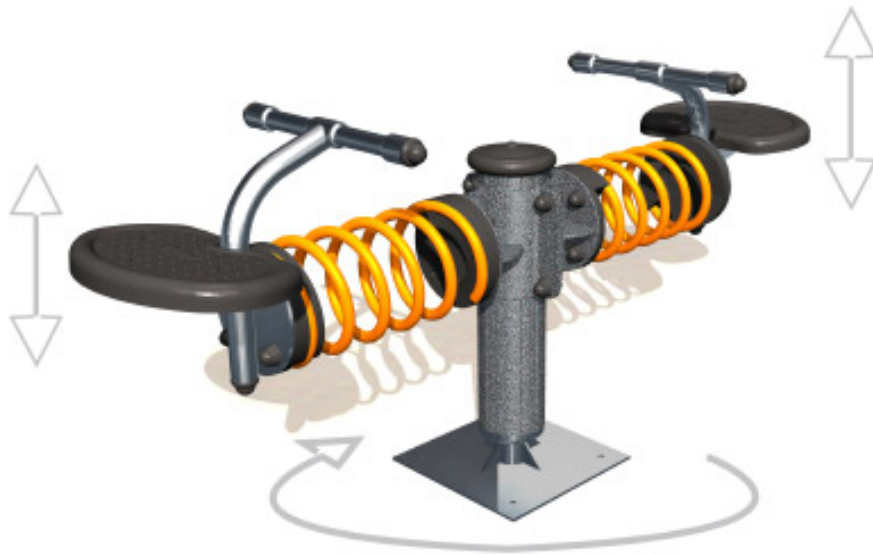

Play value

swinging



balancing



rotating



Proludic

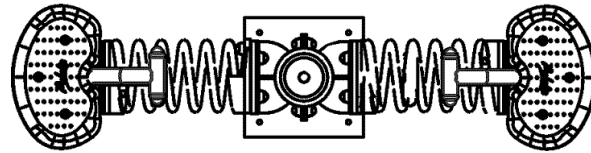



Installation of equipment



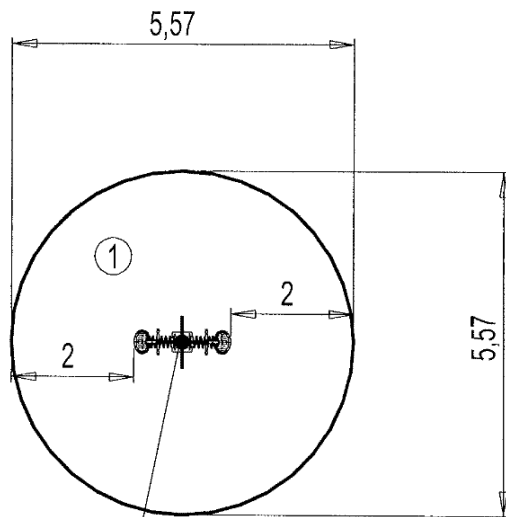





Impact area =

-  Impact area
-  Free space

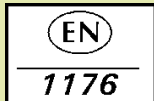

Point de Référence
Setting Out Point
Punto de referencia
Bezugspunkt

		
1	0,5m	24,5m ²

							
2	02h00	0.2m ³	24.5m ²	69kg	58kg		2007-01-01