



2-8



1



0,46m



1 = 0,58m 2 = 0,4m 3 = 0,84m

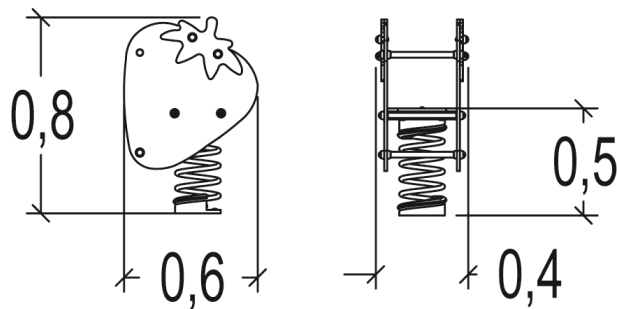
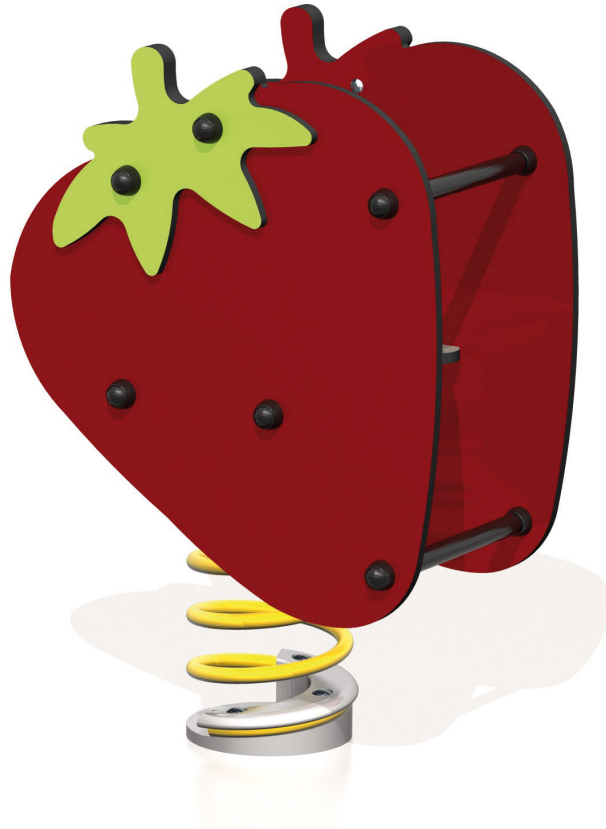

## Play value

swinging



balancing



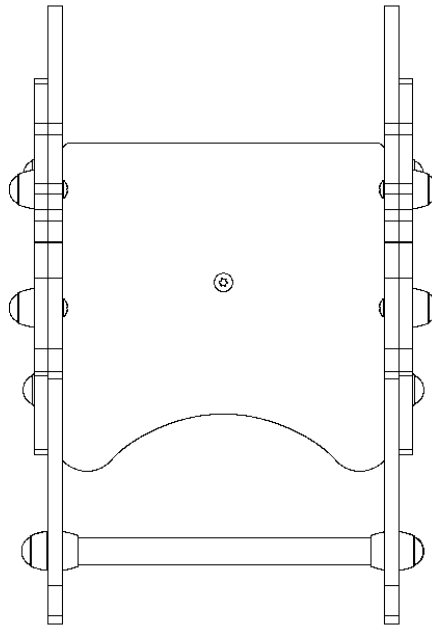



## Installation of equipment

Impact area =

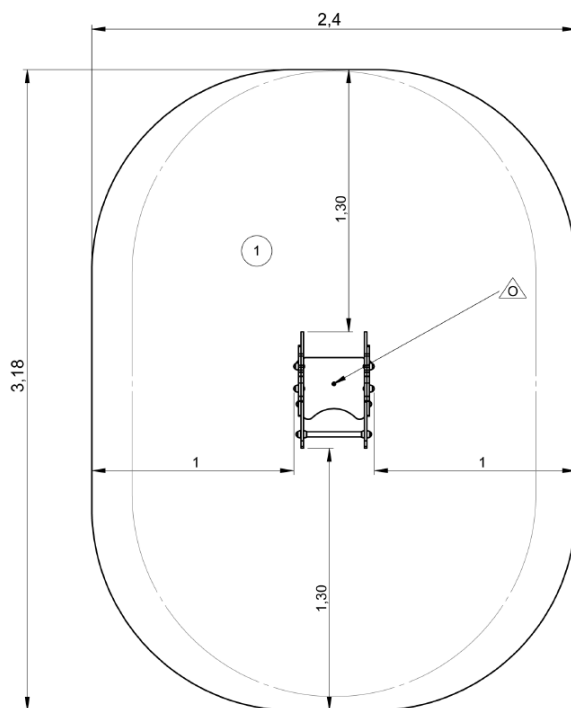
 Impact area  
 Free space



		
1	0,46m	7m <sup>2</sup>



1



01h00



0m<sup>3</sup>



7m<sup>2</sup>



31kg



11kg

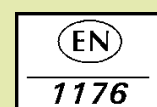

*Proludic*

2016-01-08