



6+



3



0,7m



1 = 0m 2 = 0m 3 = 0m



Motor disability



Sensorial disabilities

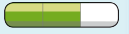

Learning disabilities

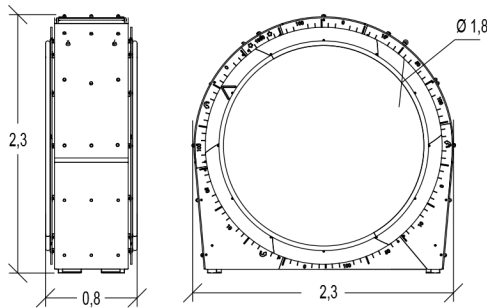
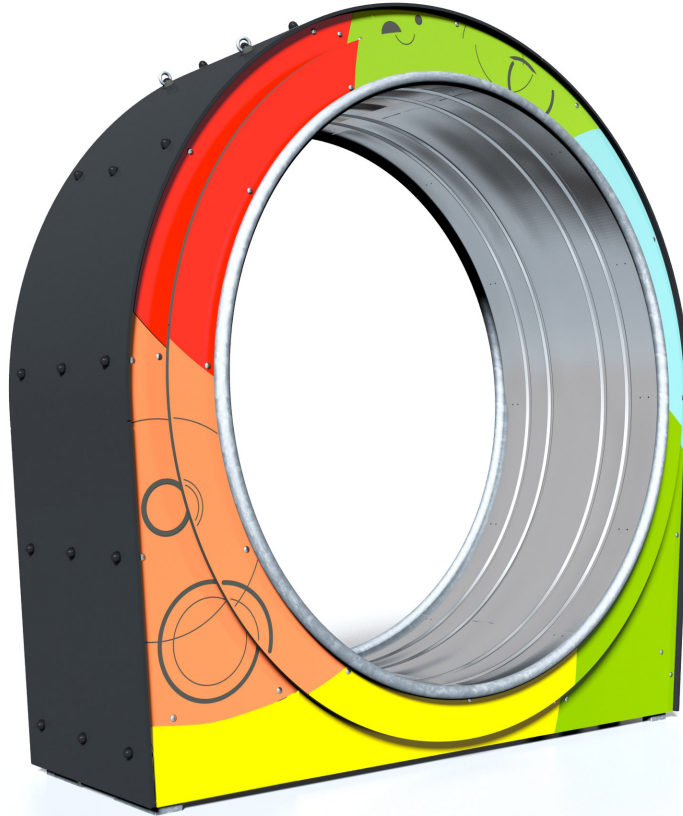

Play value : 5

meeting



balancing



rotating



visual stimulation



thinking



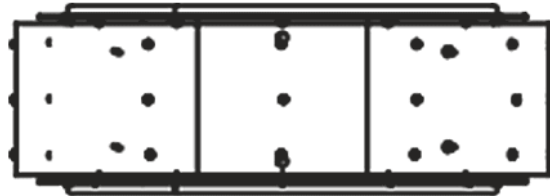



## Installation of equipment

Impact area =

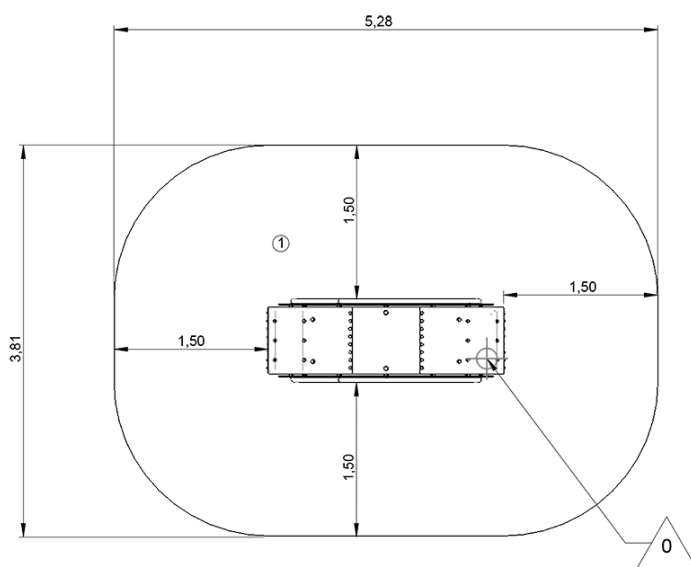
-  Impact area
-  Free space



		
1	0,7m	21m <sup>2</sup>



2



04h00



0.5m<sup>3</sup>



21m<sup>2</sup>



397kg



358kg

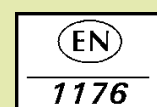

*Proludic*

0000-00-00