



3+



6



0,5m



1 = 4,04m 2 = 1,14m 3 = 1,2m



Motor disabilities
 Sensorial disabilities
 Learning disabilities

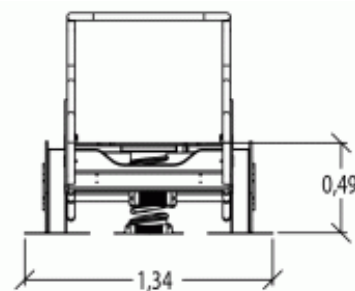
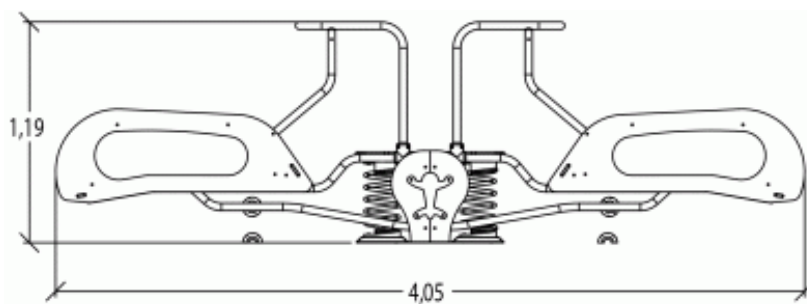
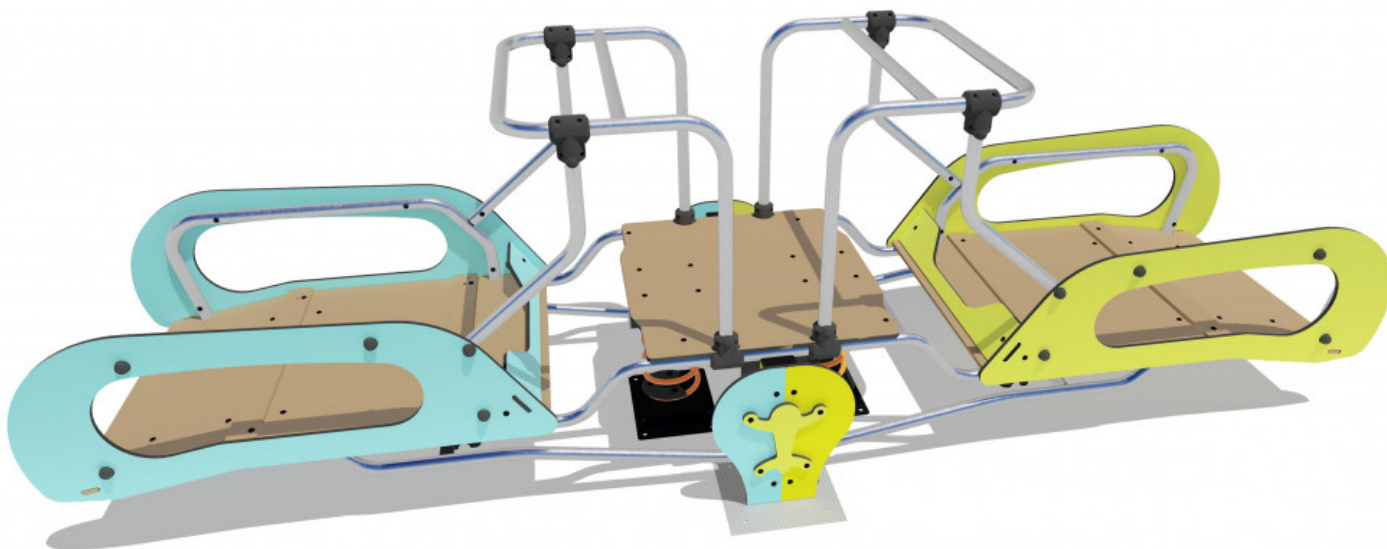

Play value : **5**

balancing



swinging



meeting



role play



resting



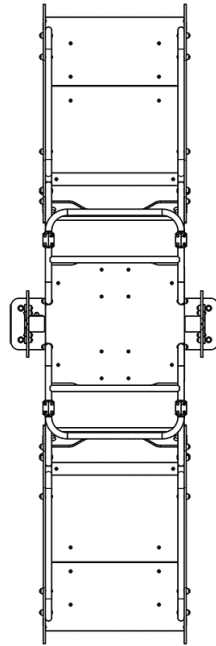







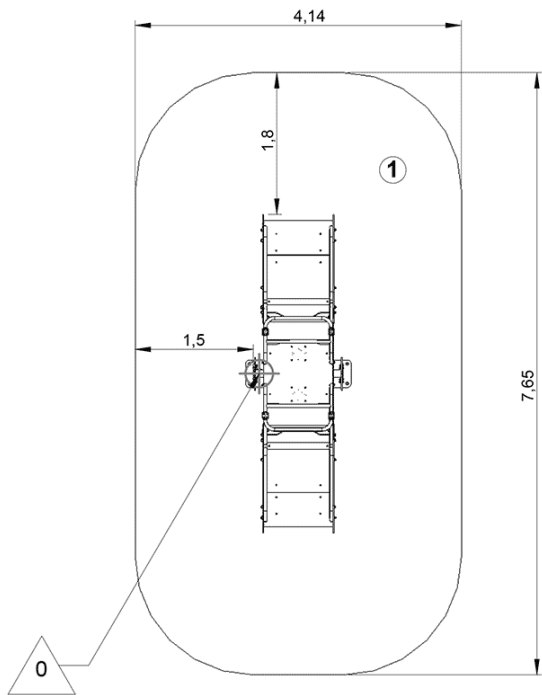



Installation of equipment

Impact area =

-  Impact area
-  Free space

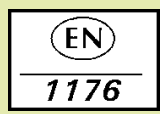

		
1	0,5m	30m ²

							
2	06h00	0m ³	30m ²	246kg	59kg		0000-00-00