

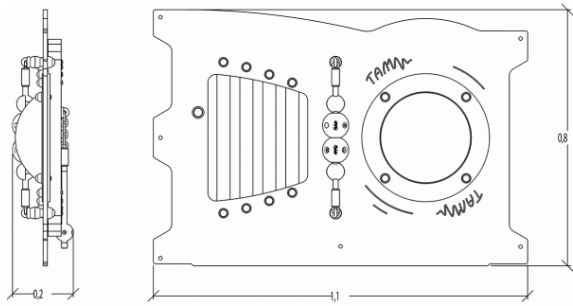

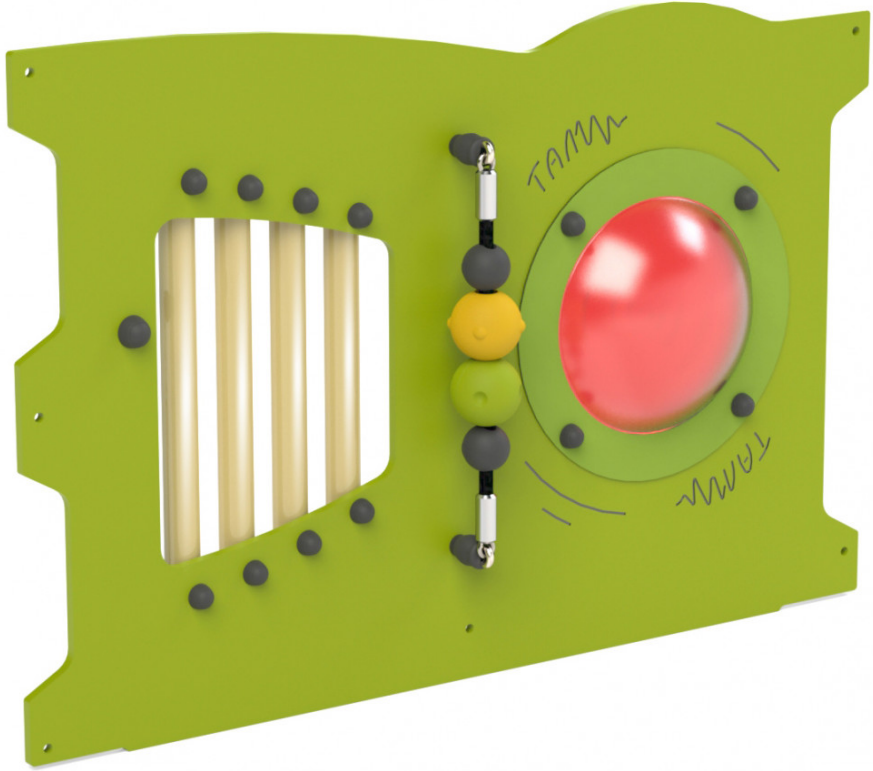



1+ | 2 | 0m | 1 = 0m 2 = 0m 3 = 0m

 Motor disabilities
 Sensorial disabilities
 Learning disabilities



Play value : 5

role play 
 meeting 
 handling 
 sound stimulation 
 tactile stimulation 









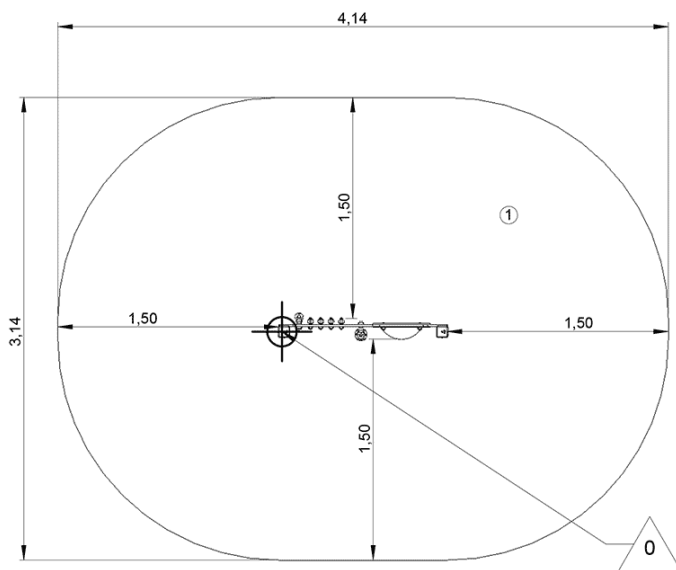

Installation of equipment

Impact area =

-  Impact area
-  Free space



| | | |
|---|---|---|
| |  |  |
| 1 | 0m | 11m ² |

| | | | | | |
|--|---|---|---|---|---|
|  |  |  |  |  |  |
| 0 | 00h50 | 0m ³ | 11m ² | 15kg | 12kg |

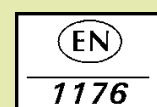

0000-00-00