



3+



6



1m



1 = 1,2m 2 = 1,2m 3 = 0,8m



Motor disabilities
 Sensorial disabilities
 Learning disabilities

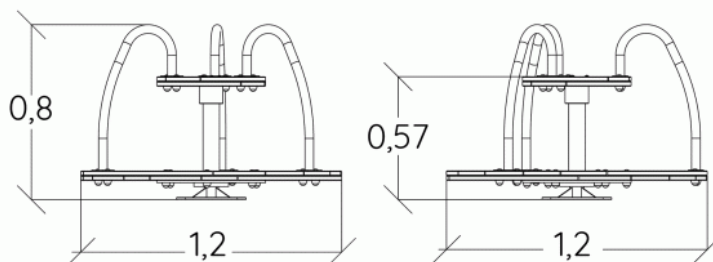
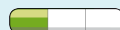
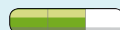
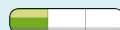

Play value : 3

meeting



balancing



rotating



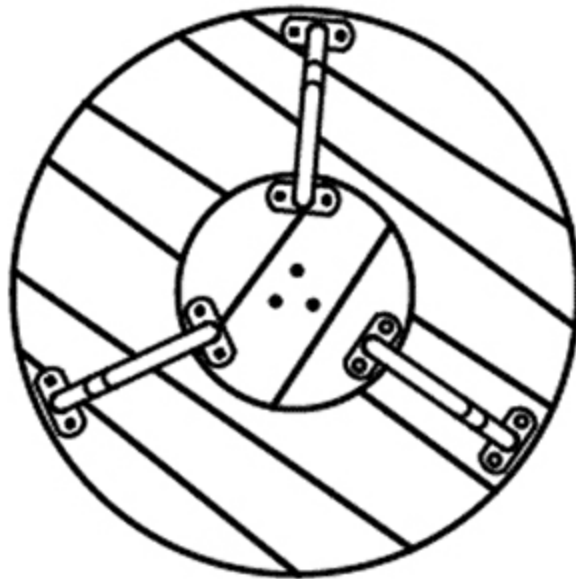







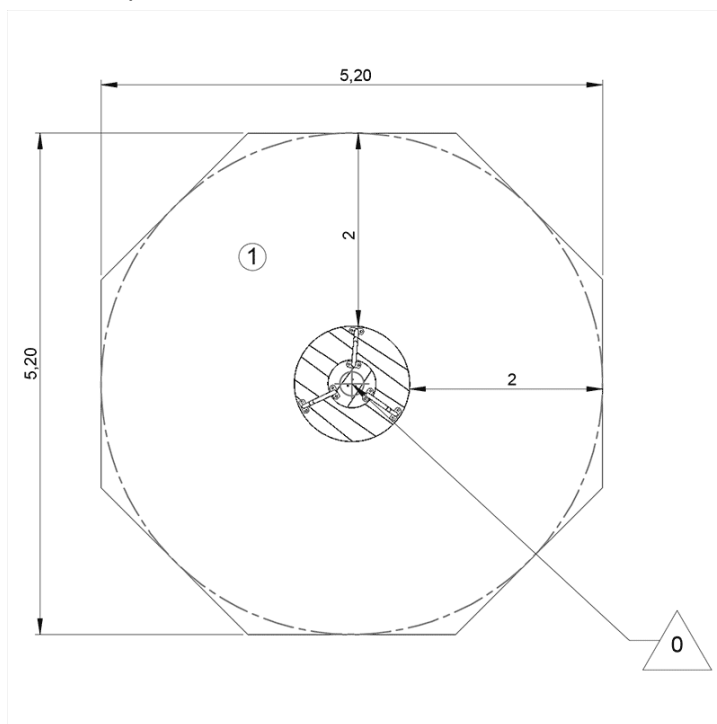

Installation of equipment

Impact area =

-  Impact area
-  Free space



| | | |
|---|---|--------------------|
|  |  | |
| 1 | 1,00m | 22,5m ² |

| | | | | | |
|--|---|---|---|---|---|
|  |  |  |  |  |  |
| 2 | 02h00 | 0.15m ³ | 22.5m ² | 100kg | 37kg |

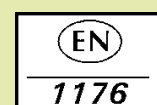

0000-00-00