



Pneumatically operated 2/2 way diaphragm valve with stainless steel actuator

- Flow optimized and deadleg free stainless steel cast or forged bodies
- Media separation with different diaphragm materials
- Trusted inner parts for long cycle life
- Actuator in stainless steel for demanding environments
- Large accessory program with stroke limitation and feedback

Type 2063 can be combined with...



Type 8697
Feedback

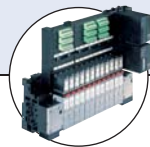

Type 8640/8644
Valve island



Type 6012/6014 P
Pilot valve

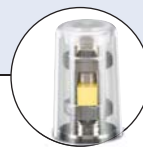

Stroke limiter

The pneumatically operated diaphragm valve with stainless steel actuators fulfils the demands of tough process environments. Forged or casted bodies in high quality stainless steel have excellent cleanability and surface qualities that are required in pharma, biopharma, cosmetic or food and beverage industry.

The stainless steel actuator is designed to withstand tough process environments. Laser welding allows a design without seals and smooth surfaces that is both cleanable and robust. With a ducted exhaust air port the actuator can be isolated from the environment an optimum from a lifetime and hygienic point of view.

The trusted diaphragm materials are optimized for a long cycle life and comply to USP Class IV, FDA and EC-Regulation 1935/2004.

Placed within the Bürkert diaphragm valve program various port connections, and a large accessory program are available, also explosion proof variants.

Technical data	
Port connection	DN15 to 50
Body material Forged version Cast version	Forged stainless steel 316L/1.4435/BN2 Cast stainless steel 316L /1.4435
Port connections Welded acc. to	EN ISO 1127/ISO 4200, DIN 11866 RB, DIN 11850 R2, DIN 11866 RA, DIN EN 10357 RB, ASME BPE, DIN 11866 RC on request: SMS 3008, BS 4825 on request
Clamp and threaded	
Actuator material Cover Diaphragm cover	1.4404 (316L) 1.4308
Diaphragm materials	EPDM (AB), PTFE/EPDM (EA) EPDM (AD), advanced PTFE/EPDM (EU), GYLON®/EPDM laminated (ER) on request
Medium	Neutral gases and liquids, high purity, sterile, aggressive or abrasive fluids
Viscosity	up to viscous
Surface finishes - forged version internal mechanical polished (with external forged surface) internal electro polished (with external forged surface electro polished)	(average surface finish) Ra ≤ 0.5 µm (ASME BPE SF1) on request Ra ≤ 0.38 µm (ASME BPE SF4)
Surface finishes - cast version internal mechanical polished (with external cast surface) internal electro polished (with external cast surface electro polished)	(average surface finish) Ra ≤ 0.76 µm (ASME BPE SF3) Ra ≤ 0.6 µm (ASME BPE SF6) on request

Content



Valve specifications

Type 2063 On/Off	
Technical data & ordering info.	p. 1-9
Forged version	p. 4-6
Cast version	p. 7-10
Dimensions	p. 10



System spec. On/Off

Type 8801-DV	
Technical data & ordering info.	p.10-14

Request for quotation

Type 8801-DF	p.13-15
--------------	---------

Technical data, *continued*

Technical data, continued	
Medium temperature EPDM (AB), PTFE/EPDM (EA), EPDM (AD), advanced PTFE/EPDM (EU) GYLON®/EPDM laminated (ER)	-10 to +130°C (steam sterilisation +140°C for 60 min) -5 to +143°C (steam sterilisation +150°C for 60 min) -5 to +130°C (steam sterilisation +140°C for 60 min)
Ambient temperature	0°C bis +60°C, autoclavable
Control medium	Neutral gases, air
Max. pilot pressure	max. 10.5 bar* * with actuator size 130mm (P) max. 7.5 bar
Pilot air ports	Thread G1/8
Installation	as required, preferably with actuator in upright position

Technical data valves

Pressure values

Diaphragm size	Actuator size Ø [mm]	Permitted pilot pressure [bar]		Max. operating pressure [bar] for seal material	
		min.	max.	EPDM	PTFE/EPDM advanced PTFE/EPDM, GYLON®/EPDM laminated
15	50 (D)	5	10.5	8.5	5
	70 (M)			10	10
20	70 (M)	5	10.5	10	10
	70 (M)			10	10
25	70 (M)	5	10.5	6.5	6
	90 (N)			10	8
40	90 (N)	5.5	10.5	10	10
	130 (P)			7.5	
50	130 (P)	5	7.5	8	7

Pressure valves [bar]: Overpressure to the atmospheric pressure

Installation for self-draining operation

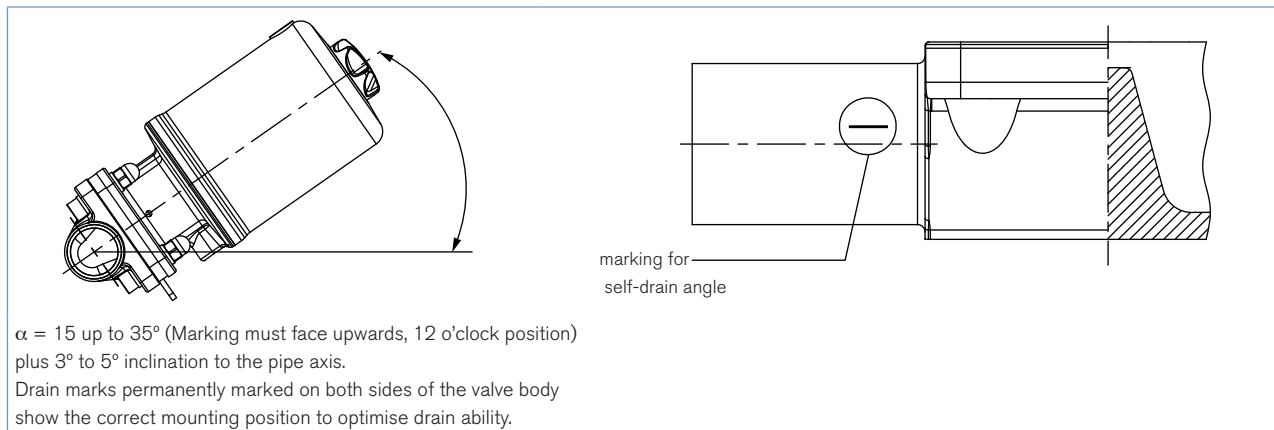

Approvals

Suitability for foodstuffs / sterile applications



- The composition of the EPDM (AB), EPDM (AD), PTFE/EPDM (EA), advanced PTFE (EU) and GYLON®/EPDM laminated (ER) diaphragms corresponds to the Code of Federal Regulations, published by the FDA (Food and Drug Administration, USA).



- The composition of the EPDM (AB), EPDM (AD), PTFE/EPDM (EA), advanced PTFE (EU) and GYLON®/EPDM laminated (ER) diaphragms is suitable for the application with food and beverage (acc. to EC-Regulation 1935/2004/EC)
- The composition of the EPDM (AB), EPDM (AD), PTFE/EPDM (EA), advanced PTFE (EU) and GYLON®/EPDM laminated (ER) diaphragms are approved acc. USP Class VI.

Materials Type 2063 Diaphragm valve

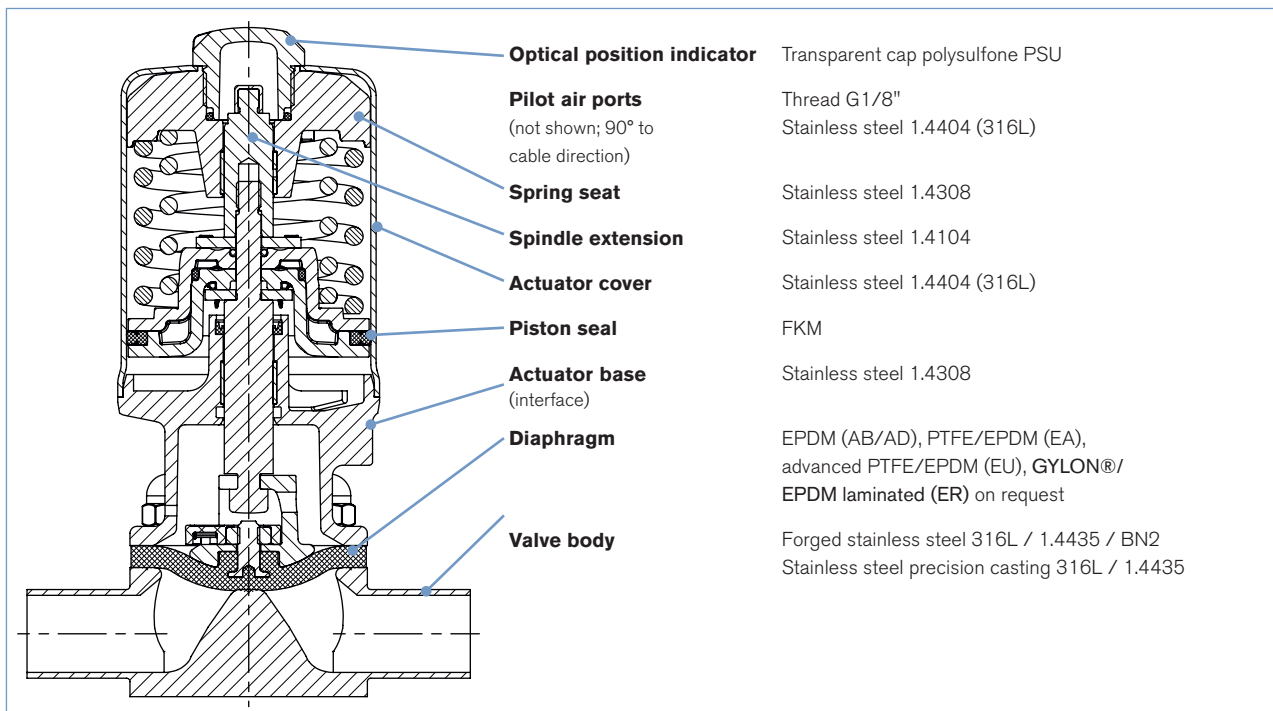

Forged

Body label

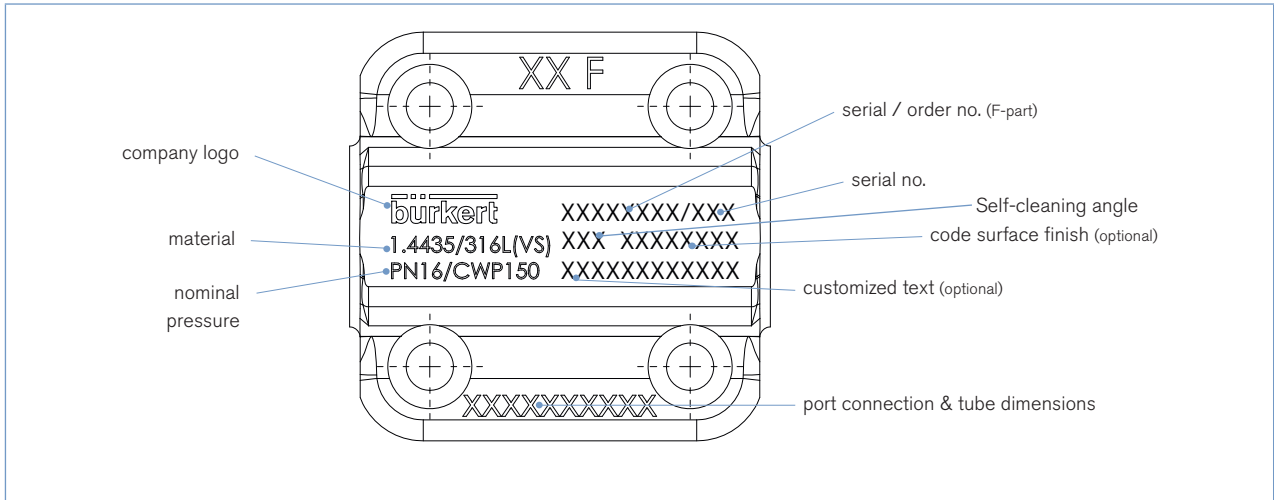

Kv-values forged body

Diaphragm size	Port connection DN		Kv-value forged [m³/h]		
	[mm]	[inch]	DIN EN ISO 1127 ISO 4200 DIN 11866 RB	DIN 11850 R2 DIN 11866 RA DIN EN 10357 RA	ASME BPE DIN11866 RC
15	15	1/2"	6.5	6.5	3.1
20	20	3/4"	12.5	12.4	8.4
25	25	1"	18	20	15.5
40	40	1 1/2"	41	40	37
50	50	2"	66	66	66

Flow rate: Kv value forged [m³/h] for elastomer membranes: Measured at +20°C, 1 bar pressure at valve inlet and free outlet.

Ordering chart Type 2063 forged diaphragm valve

Forged body with welded connection, surface finish electro polished, $Ra \leq 0.38 \mu\text{m}$ (ASME BPE SF4), and inspection 3.1 acc. to EN-ISO 10204, further on request

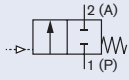
Control function	Orifice		Diaphragm size	Port connection tube \varnothing x wall thickness [mm]	Kv-value water [m ³ /h]	Actuator size \varnothing [mm]	Pilot pressure [bar]	Max. operating pressure [bar]	Item no. mechanical polished, $Ra \leq 0.38 \mu\text{m}$, incl. 3.1 certificat
	[mm]	[inch]							
A 2/2 way valve, externally controlled, normally closed by spring operation with pilot valve (NC) 	Acc. to EN ISO 1127/ISO 4200/DIN 11866 series B								
	Diaphragm material EPDM (AD)								
	15	1/2"	15	21.3 x 1.6	6.5	50 (D)	5-10.5	8.5	285 310
						70 (M)	5-10.5	10	285 311
	20	3/4"	20	26.9 x 1.6	12.5	70 (M)	5-10.5	10	285 312
	25	1"	25	33.7 x 2.0	18	70 (M)	5-10.5	6.5	285 313
						90 (N)	5.5-10.5	10	285 314
	40	1 1/2"	40	48.3 x 2.0	41	90 (N)	5.5-10.5	10	285 315
						130 (P)	5-7.5	10	285 316
	50	2"	50	60.3 x 2.0	66	130 (P)	5-7.5	8	285 317
	Diaphragm material PTFE/EPDM (EU)								
	15	1/2"	15	21.3 x 1.6	6.5	50 (D)	5-10.5	5	285 335
						70 (M)	5-10.5	10	285 336
	20	3/4"	20	26.9 x 1.6	12.5	70 (M)	5-10.5	10	285 337
	25	1"	25	33.7 x 2.0	18	70 (M)	5-10.5	6	282 091
						90 (N)	5.5-10.5	8	285 338
	40	1 1/2"	40	48.3 x 2.0	41	90 (N)	5.5-10.5	10	285 339
						130 (P)	5-7.5	10	285 340
	50	2"	50	60.3 x 2.0	66	130 (P)	5-7.5	7	285 341
	Acc. to DIN 11850 series 2/DIN 11866 series A/DIN EN 10357 series B								
	Diaphragm material EPDM (AD)								
	15	1/2"	15	19.0 x 1.5	6.5	50 (D)	5-10.5	8.5	285 301
						70 (M)	5-10.5	10	285 302
	20	3/4"	20	23.0 x 1.5	12.4	70 (M)	5-10.5	10	285 304
	25	1"	25	29.0 x 1.5	20	70 (M)	5-10.5	6.5	285 305
						90 (N)	5.5-10.5	10	285 306
	40	1 1/2"	40	41.0 x 1.5	40	90 (N)	5.5-10.5	10	285 307
						130 (P)	5-7.5	10	285 308
	50	2"	50	53.0 x 1.5	66	130 (P)	5-7.5	8	285 309
	Diaphragm material PTFE/EPDM (EU)								
	15	1/2"	15	19.0 x 1.5	6.5	50 (D)	5-10.5	5	285 326
						70 (M)	5-10.5	10	285 327
	20	3/4"	20	23.0 x 1.5	12.4	70 (M)	5-10.5	10	285 328
	25	1"	25	29.0 x 1.5	20	70 (M)	5-10.5	6	285 329
						90 (N)	5.5-10.5	8	285 330
	40	1 1/2"	40	41.0 x 1.5	40	90 (N)	5.5-10.5	10	285 331
						130 (P)	5-7.5	10	285 333
	50	2"	50	53.0 x 1.5	66	130 (P)	5-7.5	7	285 334

i Further versions on request

**Material**

Diaphragm EPDM (AB), advanced PTFE/EPDM (EU), GYLON®/EPDM laminated (ER)

**Port connection**

Clamp acc. to SMS3008; Tri-Clamps acc. to ASME BPE, DIN 32676 series A, ISO 2852 / SMS 3017; others on request

**Control function**

B (normally closed by spring action) / I (double acting)

**Additional**Surface finishes, mechanical polished $Ra \leq 0.5 \mu\text{m}$ (ASME BPE SF5)
Versions with reduced spring force for higher membrane life

Ordering chart Type 2063 forged diaphragm valve, *continued*

Forged body with welded connection, surface finish electro polished, $Ra \leq 0.38 \mu\text{m}$ (ASME BPE SF4), and inspection 3.1 acc. to EN-ISO 10204, further on request

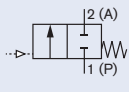
Control function	Orifice		Diaphragm size	Port connection tube \varnothing x wall thickness [mm]	Kv-value water [m ³ /h]	Actuator size \varnothing [mm]	Pilot pressure [bar]	Max. operating pressure [bar]	Item no. mechanical polished, $Ra \leq 0.38 \mu\text{m}$, incl. 3.1 certificat
	[mm]	[inch]							
A 2/2 way valve, externally controlled, normally closed by spring operation with pilot valve (NC) 	Acc. to ASME BPE/DIN 11866 series C								
	Diaphragm material EPDM (AD)								
	15	1/2"	15	12.7 x 1.65	3.1	50 (D)	5-10.5	8.5	285 292
						70 (M)	5-10.5	10	285 294
	20	3/4"	20	19.05 x 1.65	8.4	70 (M)	5-10.5	10	285 295
	25	1"	25	25.4 x 1.65	15.5	70 (M)	5-10.5	6.5	285 296
						90 (N)	5.5-10.5	10	285 297
	40	1 1/2"	40	38.1 x 1.65	37	90 (N)	5.5-10.5	10	285 298
						130 (P)	5-7.5	10	285 299
	50	2"	50	50.8 x 1.65	66	130 (P)	5-7.5	8	285 300
	Diaphragm material PTFE/EPDM (EU)								
	15	1/2"	15	12.7 x 1.65	3.1	50 (D)	5-10.5	5	285 318
						70 (M)	5-10.5	10	285 319
	20	3/4"	20	19.05 x 1.65	8.4	70 (M)	5-10.5	10	285 320
	25	1"	25	25.4 x 1.65	15.5	70 (M)	5-10.5	6	285 321
						90 (N)	5.5-10.5	8	285 322
	40	1 1/2"	40	38.1 x 1.65	37	90 (N)	5.5-10.5	10	285 323
						130 (P)	5-7.5	10	285 324
	50	2"	50	50.8 x 1.65	66	130 (P)	5-7.5	7	285 325

i Further versions on request



Material

Diaphragm EPDM (AB), advanced PTFE/EPDM (EU), GYLON®/EPDM laminated (ER)



Port connection

Clamp acc. to SMS3008; Tri-Clamps acc. to ASME BPE, DIN 32676 series A, ISO 2852 / SMS 3017; others on request



Control function

B (normally closed by spring action) / I (double acting)



Additional

Surface finishes, mechanical polished $Ra \leq 0.5 \mu\text{m}$ (ASME BPE SF5)
 Versions with reduced spring force for higher membrane life

Cast

Kv-value cast body

Diaphragm size	Actuator size DN		Kv-value [m ³ /h]
	[mm]	[inch]	
15	15	1/2"	5.5
20	20	3/4"	10
25	25	1"	14
40	40	1 1/2"	30
50	50	2"	51.5

Flow rate: Kv value forged [m³/h] for elastomer membranes: Measured at +20°C, 1 bar pressure at valve inlet and free outlet.

Ordering chart Type 2063 cast version

Cast body with welded connection, surface finish mechanical polished, Ra ≤ 0.8 µm, others on request

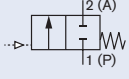
Control function	Orifice		Diaphragm size	Port connection tube Ø x wall thickness [mm]	Kv-value water [m³/h]	Actuator size Ø [mm]	Pilot pressure [bar]	Max. operating pressure [bar]	Item no. mechanical polished, Ra < 0.8 µm
	[mm]	[inch]							
A 2/2 way valve, externally controlled, normally closed by spring operation with pilot valve (NC) 	Acc. to EN ISO 1127/ISO 4200/DIN 11866 series B								
	Diaphragm material EPDM (AD)								
	15	1/2"	15	21.3 x 1.6	5.5	50 (D)	5-10.5	8.5	285 259
						70 (M)	5-10.5	10	285 260
	20	3/4"	20	26.9 x 1.6	10.0	70 (M)	5-10.5	10	285 262
	25	1"	25	33.7 x 2.0	14.0	70 (M)	5-10.5	6.5	285 263
						90 (N)	5.5-10.5	10	285 264
	40	1 1/2"	40	48.3 x 2.0	30.0	90 (N)	5.5-10.5	10	285 267
						130 (P)	5-7.5	10	285 268
	50	2"	50	60.3 x 2.0	51.5	130 (P)	5-7.5	8	285 269
	Diaphragm material PTFE/EPDM (EA)								
	15	1/2"	15	21.3 x 1.6	5.5	50 (D)	5-10.5	5	285 284
						70 (M)	5-10.5	10	285 285
	20	3/4"	20	26.9 x 1.6	10.0	70 (M)	5-10.5	10	285 286
	25	1"	25	33.7 x 2.0	14.0	70 (M)	5-10.5	6	285 287
						90 (N)	5.5-10.5	8	285 288
	40	1 1/2"	40	48.3 x 2.0	30.0	90 (N)	5.5-10.5	10	285 289
						130 (P)	5-7.5	10	285 290
	50	2"	50	60.3 x 2.0	51.5	130 (P)	5-7.5	7	285 291
	Acc. to DIN 11850 series 2/DIN 11866 series A/DIN EN 10357 series B								
	Diaphragm material EPDM (AD)								
	15	1/2"	15	19.0 x 1.5	5.5	50 (D)	5-10.5	8.5	285 250
						70 (M)	5-10.5	10	285 252
	20	3/4"	20	23.0 x 1.5	10.0	70 (M)	5-10.5	10	285 253
	25	1"	25	29.0 x 1.5	14.0	70 (M)	5-10.5	6.5	285 254
						90 (N)	5.5-10.5	10	285 255
	40	1 1/2"	40	41.0 x 1.5	30.0	90 (N)	5.5-10.5	10	285 256
						130 (P)	5-7.5	10	285 257
	50	2"	50	53.0 x 1.5	51.5	130 (P)	5-7.5	8	285 258
	Diaphragm material PTFE/EPDM (EA)								
15	1/2"	15	19.0 x 1.5	5.5	50 (D)	5-10.5	5	285 276	
					70 (M)	5-10.5	10	285 277	
20	3/4"	20	23.0 x 1.5	10.0	70 (M)	5-10.5	10	285 278	
25	1"	25	29.0 x 1.5	14.0	70 (M)	5-10.5	6	285 279	
					90 (N)	5.5-10.5	8	285 280	
40	1 1/2"	40	41.0 x 1.5	30.0	90 (N)	5.5-10.5	10	285 281	
					130 (P)	5-7.5	10	285 282	
50	2"	50	53.0 x 1.5	51.5	130 (P)	5-7.5	7	285 283	



Further versions on request



Material

Diaphragm EPDM (AB), advanced PTFE/EPDM (EU) and FKM (FF)



Port connection

Clamp acc. to SMS3008; Tri-Clamps acc. to ASME BPE, DIN 32676 series A, ISO 2852 / SMS 3017; others on request



Control function

B (normally closed by spring action) / I (double acting)



Additional

Surface finishes electro polished Ra ≤ 0.6 µm (ASME BPE SF6)

Ordering chart Type 2063 cast version

Cast body with welded connection, surface finish mechanical polished, Ra <= 0.8 µm, others on request

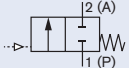
Control function	Orifice		Diaphragm size	Port connection tube Ø x wall thickness [mm]	Kv-value water [m³/h]	Actuator size Ø [mm]	Pilot pressure [bar]	Max. operating pressure [bar]	Item no. mechanical polished, Ra <= 0.8 µm
	[mm]	[inch]							
A 2/2 way valve, externally controlled, normally closed by spring operation with pilot valve (NC) 	Acc. to ASME BPE/DIN 11866 series C								
	Diaphragm material EPDM (AD)								
	20	3/4"	20	19.05 x 1.65	10.0	70 (M)	5-10.5	10	285 243
	25	1"	25	25.4 x 1.65	14.0	70 (M)	5-10.5	6.5	285 244
						90 (N)	5.5-10.5	10	285 246
	40	1 1/2"	40	38.1 x 1.65	30.0	90 (N)	5.5-10.5	10	285 247
						130 (P)	5-7.5	10	285 248
	50	2"	50	50.8 x 1.65	51.5	130 (P)	5-7.5	8	285 249
	Diaphragm material PTFE/EPDM (EA)								
	20	3/4"	20	19.05 x 1.65	10.0	70 (M)	5-10.5	10	285 270
	25	1"	25	25.4 x 1.65	14.0	70 (M)	5-10.5	6	285 271
						90 (N)	5.5-10.5	8	285 272
	40	1 1/2"	40	38.1 x 1.65	30.0	90 (N)	5.5-10.5	10	285 273
						130 (P)	5-7.5	10	285 274
	50	2"	50	50.8 x 1.65	51.5	130 (P)	5-7.5	7	285 275

i Further versions on request

**Material**

Diaphragm EPDM (AB), advanced PTFE/EPDM (EU), GYLONR/EPDM laminated (ER)

**Port connection**

Clamp acc. to SMS3008; Tri-Clamps acc. to ASME BPE, DIN 32676 series A, ISO 2852 / SMS 3017; others on request

**Control function**

B (normally closed by spring action) / I (double acting)

**Additional**

Surface finishes electro polished Ra ≤ 0.6 µm (ASME BPE SF6)

Dimensions Type 2063 forged and cast diaphragm valve [mm]

Forged

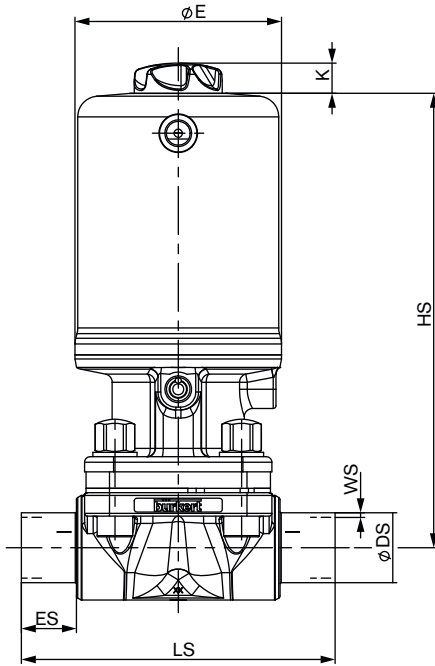

All bodies						acc. to EN ISO 1127/ISO 4200/ DIN 11866 series B				acc. to ASME BPE/DIN 11866 series C				
Orifice		Dia- phragm size	Ac- tuator size	ØE [mm]	K [mm]	HS [mm]	LS [mm]	ES [mm]	ØDS [mm]	WS [mm]	LS [mm]	ES [mm]	ØDS [mm]	WS [mm]
[mm]	[inch]													
15	1/2"	15	50 (D)	55	26.5	131	110	30.8	21.3	1.6	108	29.8	12.7	1.65
			70 (M)	75	26.5	139.4								
20	3/4"	20	70 (M)	75	26.5	154.3	119	29.6	26.9	1.6	117	28.3	19.05	1.65
25	1"	25	70 (M)	75	26.5	165.1	129	20	33.7	2	114	20	25.4	1.65
			90 (N)	96	29	187								
40	1 1/2"	40	90 (N)	96	29	206.5	161	20	48.3	2	159	34.5	38.1	1.65
			130 (P)	137	29	258.9								
50	2"	50	130 (P)	137	29	272.7	192	20	76.1	2.3	190	41	63.5	1.65

All bodies						acc. to DIN 11850 series 2/DIN 11866 series A/ DIN EN 10357 series B,				
Orifice		Dia- phragm size	Ac- tuator size	ØE [mm]	K [mm]	HS [mm]	LS [mm]	ES [mm]	ØDS [mm]	WS [mm]
[mm]	[inch]									
15	1/2"	15	50 (D)	55	26.5	131	110	30.8	19	1.5
			70 (M)	75	26.5	139.4				
20	3/4"	20	70 (M)	75	26.5	154.3	119	20	23	1.5
25	1"	25	70 (M)	75	26.5	165.1	129	20	29	1.5
			90 (N)	96	29	187				
40	1 1/2"	40	90 (N)	96	29	206.5	161	20	41	1.5
			130 (P)	137	29	258.9				
50	2"	50	130 (P)	137	29	272.7	192	42	70	2

**2063 forged
System On/Off
8801-DV**

Ordering information for valve system On/Off with stainless steel actuator Type 8801-DV

An On/Off valve system with stainless steel actuator, Type 8801-DV, consists of a diaphragm valve, Type 2063 and position feedback Type 8697 (see separate datasheets; 8801 DV with 8697 feedback function)

**Diaphragm valve Type 2063
welded connection**



Feedback

Type 8697



Electrical position feedback

**More
info.**



Type 8697

Actuator size 50 to 130

The pneumatic control unit Type 8697 is designed for integrated mounting on CLASSIC series 20XX process valves suiting the requirements of hygienic process environment. Mechanical or inductive limit switches register the position of the valve.

Features

- Compact design
- LED position indicator
- Mechanical or inductive limit switches for end position registering
- Easy to clean chemically resistant housing featuring IP65 / IP67, 4X Rating
- Optional intrinsically safe version acc. to ATEX

Benefits

- Easy and quick installation
- High level of signal reliability thanks to self adjusting limit switches
- Signal safety through the automatic adjustment of the limit switches
- Minimised space requirement in the plant piping for more flexibility in plant design

Valve System On/Off



**Type 8801-DV
2063 + 8697**

Ordering chart for accessories

Accessories has to be ordered separately

Accessory	for actuator size	Item no.
Stainless steel Silencer Set (VA-Silencer incl. PTFE sealing ring)	universal	696 931
Max. stroke limitation	D (Ø50), M (Ø70)	699 550
	N (Ø90), P (Ø130)	699 994
Min./Max. stroke limitation	D (Ø50), M (Ø70)	699 986
	N (Ø90), P (Ø130)	699 998
Proximity switch (single)	D (Ø50), M (Ø70)	699 989
	N (Ø90), P (Ø130)	699 991
Proximity switch (double)	D (Ø50), M (Ø70)	699 990
	N (Ø90), P (Ø130)	699 992
Adaptionsset 8697*	D (Ø50), M (Ø70)	699 551
	N (Ø90), P (Ø130)	580 000
8697*	universal	depending on version

For further accessories see accessories datasheet Type 2XXX for the full options programme.

More info.

Valve features, specification key - Request for quotation

Example

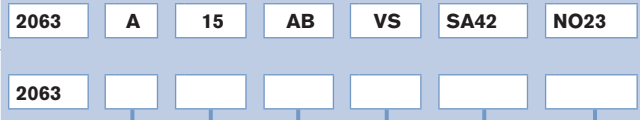

Specification key

(Please make a choice)

CONTROL FUNCTION

A	normally closed by spring action
B	normally open by spring action
I	double acting

ORIFICE [mm] (diaphragm)

08
10
15
20
25
32
40
50

SEAL MATERIAL

AB	EPDM
AD	EPDM
EA	PTFE/EPDM
ER	GYLON®/EPDM laminated
EU	advanced PTFE/EPDM in two pieces

BODY MATERIAL

VG	Stainless steel, cast 316L / 1.4435
VS	Forged stainless steel 316L/1.4435/BN2

VARIABLE CODES

Surfaces - forged design	
NO14	Int. Mechanical polished Ra ≤ 0.5 µm (ASME BPE SF1)
NO17	Int. Electro polished Ra ≤ 0.38 µm (ASME BPE SF4)
Surfaces - cast version	
NO06	Int. Mechanical polished Ra ≤ 0.76 µm (ASME BPE SF3)
NO16	Int. Electro polished Ra ≤ 0.6 µm (ASME BPE SF6)
EC04	Reduced spring force

Standard



DN [mm]	Port connection weld end							
	EN ISO 1127/ ISO 4200 DIN 11866 S. B	SMS 3008	DIN 11850 S. 0	DIN 11850 R. 1	DIN 11850 S. 2 DIN 11866 S. A	DIN 11850 R. 3	BS4825	ASME BPE DIN 11866 S. C
8	SA40 - 13.5x1.6		SC42 - 10.0x1.0				SODB - 6.35x1.2	SA90 - 6.35x0.89
10	SA41 - 17.2x1.6			SF40 - 12.0x1.0	SD40 - 13.0x1.5	SE40 - 14.0x2.0	SODC - 9.53x1.2	SA91 - 9.53x0.89
15	SA42 - 21.3x1.6	SA58 - 12.0x1.0	SC43 - 18.0x1.5	SF41 - 18.0x1.0	SD42 - 19.0x1.5	SE42 - 20.0x2.0	SODD - 12.7x1.2	SA92 - 12.7x1.65
20	SA43 - 26.9x1.6	SA59 - 18.0x1.0	SC44 - 22.0x1.5	SF42 - 22.0x1.0	SD43 - 23.0x1.5	SE43 - 24.0x2.0	SODE - 19.05x1.2	SA93 - 19.05x1.65
25	SA44 - 33.7x2.0	SA60 - 25.0x1.2	SC45 - 28.0x1.5	SF43 - 28.0x1.0	SD44 - 29.0x1.5	SE44 - 30.0x2.0		SODF - 25.4x1.65
32	SA45 - 42.4x2.0	SA61 - 33.7x1.2	SC46 - 34.0x1.5	SF44 - 34.0x1.0	SD45 - 35.0x1.5	SE45 - 36.0x2.0		
40	SA46 - 48.3x2.0	SA62 - 38.0x1.2	SC47 - 40.0x1.5	SF45 - 40.0x1.0	SD46 - 41.0x1.5	SE46 - 42.0x2.0		SODH - 38.1x1.65
50	SA47 - 60.3x2.0	SA63 - 51.0x1.2	SC48 - 52.0x1.5	SF46 - 52.0x1.0	SD47 - 53.0x1.5	SE47 - 54.0x2.0		SODI - 50.8x1.65

DN [mm]	Port connection Clamp				
	Clamp 34.0 like DIN 32676 S. B (ISO-tube (ISO4200))	DIN 32676 S. A (DIN-tube (DIN11850))	DIN 32676 S. B (ISO-tube (ISO4200))	ASME BPE	BS 4825 (Clamp BS 4825-3, tube BS 4825-1)
8	TC51 - 13.5x1.6 Ci: 34.0	TD40 - 10.0x1.0 Ci: 25.0	TC40 - 13.5x1.6 Ci: 25.0	TG50 - 6.35x0.89 Ci: 25.0	
10	TC41 - 17.2x1.6 Ci: 34.0	TD41 - 13.0x1.5 Ci: 34.0	TC53 - 17.2x1.6 Ci: 25.0	TG01 - 9.53x0.89 Ci: 25.0	
15	TC42 - 21.3x1.6 Ci: 34.0	TD42 - 19.0x1.5 Ci: 34.0	TC52 - 21.3x1.6 Ci: 50.5	TG02 - 12.7x1.65 Ci: 25.0	TH42 - 12.7x1.2 Ci: 25.0
20		TD43 - 23.0x1.5 Ci: 34.0	TC43 - 26.9x1.6 Ci: 50.5	TG03 - 19.05x1.65 Ci: 25.0	TH43 - 19.05x1.2 Ci: 25.0
25		TD44 - 29.0x1.5 Ci: 50.5	TC44 - 33.7x2.0 Ci: 50.5	TG04 - 25.4x1.65 Ci: 50.5	
32					
40		TD46 - 41.0x1.5 Ci: 50.5	TC46 - 48.3x2.0 Ci: 64.0	TG05 - 38.1x1.65 Ci: 50.5	
50		TD47 - 53.0x1.5 Ci: 64.0	TC47 - 60.3x2.0 Ci: 77.5	TG06 - 50.8x1.65 Ci: 64.0	

Valve system On/Off with stainless steel actuator Type 8801-DV – request for quotation

Please fill out and send to your nearest Bürkert facility* with your inquiry or order

Company	Contact person
Customer no.	Department
Address	Tel./Fax
Postcode/town	E-Mail

= mandatory fields to fill out

Quantity

Required delivery date

Operating data

Pipe line DN PN
 Pipe material
 Process medium
 Type of media Liquid Steam Gas

Valve features

Specification key

2063

(automatically transferred from p. 15)

Surface finish (if not standard) internal µm external µm
 Pilot pressure min. max.
 ATEX II 2GD Mechanical

Automation unit features

Click on the orange box "More info"... you will come to our website for the resp. product where you can download the data sheet.

Electrical Feedback

Type 8697
 For actuator size 50 to 130



- LED-position indicator
- Micro- or proximity switches for end position feedback
- Gehäuse nach IP 65/67, 4X Rating
- Optional intrinsically safe version acc. to ATEX / IECEx

Position feedback switches

- Micro-switch 24V DC
- Micro-switch 50 – 225 V DC/AC
- Inductive switch 3-wire PNP
- Inductive switch 2-wire NAMUR
- Inductive switch 2-wire 24V DC

Electrical connection

- Cable gland
- M12 plug
(only with inductive switch 3-wire PNP)

No. of Position feedback switches Approvals

- 2x
- ATEX cat. 3GD, IECEx
- ATEX cat. 2DG, IECEx
- without

Valve system On/Off with stainless steel actuator Type 8801-DV, *continued*

Certifications

- Certificate of compliance with the order EN-ISO 10204 2.1 (order no. 440788)
- Test report 2.2 2.2 EN-ISO 10204 (order no. 803722)
- Test certificate 3.1 according to EN-ISO 10204 (included with forged housing version)
- Certification of conformity for surface quality DIN 4762-DIN 4768-ISO / 4287/1 (order no. 804 175)
- Certification of conformity for pickling and electro polish processes (order no. 444 900)
- Food & Beverage (according to EC Directive 1935/2004 / EC)
- Certification according to FDA and USP

Comment /sketch

DTS 1000291829 EN Version: A Status: RL (released | freigegeben | valide) printed: 24.10.2016

To find your nearest Bürkert facility, click on the orange box → www.burkert.com

In case of special application conditions,
please consult for advice.

Subject to alteration.
© Christian Bürkert GmbH & Co. KG

1604/0_EU-en_00895316