



Type 2101 can be combined with...



**Type 8691**

Control Head



**Type 8695**

Control Head



**Type 8690**

Pneumatic  
Control Unit



**Type 8697**

Pneumatic  
Control Unit

## Pneumatically operated 2/2 way globe valve ELEMENT for decentralized automation

- Compact design
- Long service life
- Long service life Easy integration of automation units with ELEMENT
- Stainless steel housing with threaded, wclamp or weld connection
- Suitable for 10 bar(g) steam



For process valves with centralized automation see CLASSIC Type 20xx

The globe valve Type 2101 is specially optimized for decentralized process automation and fulfills tough criteria for process environments. The design enables the easy integration of automation units whether they are electrical/ optical position feedback, pneumatic control units or an integrated fieldbus interface. Unrivalled cycle life and sealing integrity is guaranteed by the proven self adjusting spindle packing with V-seals.

The fully integrated system has a compact and smooth design, integrated pneumatic lines, IP65/67, NEMA Type 4X protection class and superior chemical resistance.

Technical data	
<b>Orifice</b>	DN15 to DN100
<b>Port connections</b>	DIN EN 1092-1, ANSI B16.5, JIS 10K on request
Flange acc. to Welded and threaded	
<b>Body material</b>	Cast stainless steel 316L
<b>Nominal pressure</b>	PN25 (Body)
<b>Actuator material</b>	PPS / Stainless steel 1.4561 (316Ti)
Actuator / Cover	
<b>Sealing material</b>	PTFE
<b>Medium</b>	Water, alcohol, oils, fuels, hydraulic fluids, salt solution, alkali solutions, organic solvents, steam optional fuel gas (EC Gas Appliances Directive 2009/142/EG)
<b>Viscosity</b>	max. 600 mm <sup>2</sup> /s
<b>Spindle packing</b>	PTFE V-rings with spring compensation
<b>Medium temperature</b>	- 10 to + 185 °C
<b>Ambient temperature</b>	- 10 to + 60 °C (push-in air ports) - 10 to + 100 °C (threaded air ports)
<b>Control medium</b>	Neutral gases, air
<b>Max. pilot pressure</b>	max. 10 bar; actuator size 130 mm, 7 bar
<b>Pilot air ports</b>	Push-in connector for external Ø 6 mm or ¼" tube, thread G ½ (on request)
<b>Installation</b>	As required, preferably with actuator in upright position

## Content

Valve specifications		System spec. On/Off ELEMENT		Request for quotation
 Type 2101		 Type 8801-GC		Type 8801-GC
Technical data & ordering info.	p. 1 - 8	Technical data & ordering info.	p. 9 - 16	p.15









**2101**  
**System On/Off**  
**ELEMENT 8801-GC**

**Ordering information for decentralized automation of On/Off ELEMENT valve system Type 8801-GC**

A decentralized, automated **On/Off ELEMENT valve system Type 8801-GC** consists of a **globe valve Type 2101** and a valve actuation system control head **Type 8691/8695** or a pneumatic control unit **Type 8690/8697** (see separate datasheets).

For the configuration of further valve systems please use the "Request for quotation" on p. 16-17.

You order two components and receive a complete assembled and certified valve.

<b>Globe valve Type 2101</b>	<b>Control Head</b>		<b>Control Head / Feedback</b>	
	Type 8691	Type 8695	Type 8690	Type 8697
	 <b>More info.</b>	 <b>More info.</b>	 <b>More info.</b>	 <b>More info.</b>
<b>Valve System On/Off ELEMENT</b>				
				
	<b>Valve System</b> <b>Type 8801-GC-H</b> 2101 + 8691 (Actuator size Ø 70/90/130 mm)	<b>Valve System</b> <b>Type 8801-GC-M</b> 2101 + 8695 (Actuator size Ø 50 mm)	<b>Valve System</b> <b>Type 8801-GC-K</b> 2101 + 8690 (Actuator size Ø 70/90/130 mm)	<b>Valve System</b> <b>Type 8801-GC-U</b> 2101 + 8697 (Actuator size Ø 50 mm)

*A detailed description of the control heads and pneumatic control units is on the next page. →*

Ordering information for decentralized automation of On/Off ELEMENT valve system Type 8801-GC

Control Head



More info.



More info.

**Type 8691**

Actuator size Ø 70/90/130 mm

**Type 8695**

Actuator size Ø 50 mm

The Control Head Type 8691/ 8695 is optimised for integrated mounting on the 21XX process valve series. The registration of the valve end position is done through a contactless analog position sensor, which automatically recognises and saves the valve end position through the Teach function when starting up. The integrated pilot valve controls single or double-acting actuators. The status of the valve is shown through high power coloured LEDs.

**Features**

- High power coloured Status-LEDs
- Contactless inductive position sensor
- Pilot valve with manual override
- Teach function for automatic registration of valve positions
- Hygienic stainless steel design
- Easy to clean chemically resistant housing featuring IP65 / IP67, 4X Rating
- AS-Interface or DeviceNet Fieldbus communication

**Benefits**

- Easy and safe Start-up through Teach function
- Easy process monitoring and error detection through clearly visible high-power coloured LEDs
- High plant availability due to prolonged actuator life boosted by spring chamber ventilation
- Minimised space requirement in the plant piping for more flexibility in plant design

Pneumatic Control Unit / Feedback



More info.



More info.

**Type 8690**

Actuator size Ø 70/90/130 mm

**Type 8697**

Actuator size Ø 50 mm

The pneumatic control unit Type 8697/8690 is optimised for integrated mounting on the 21XX process valve series. Mechanical or inductive limit switches register the position of the valve. The integrated pilot valve controls single or double-acting (8690) actuators.

**Features**

- Visual position indicator
- Mechanical or inductive limit switches for end position registering
- Pilot valve with manual override
- Compact design
- Easy to clean chemically resistant housing featuring IP65 / IP67, 4X Rating
- Optional intrinsically safe version acc. to ATEX / IECEx

**Benefits**

- Easy and safe Start-up through Teach function (Type 8697)
- High level of signal reliability thanks to self adjusting limit switches
- Minimised space requirement in the plant piping for more flexibility in plant design

Technical data globe valve Type 2101 flow direction below the seat (for gases and liquids)

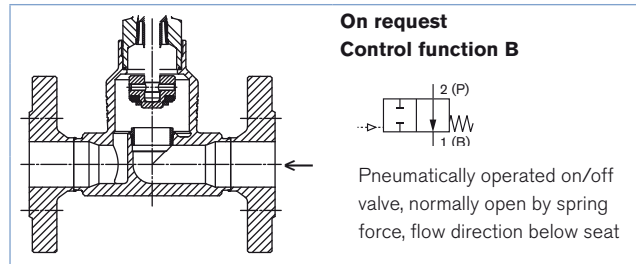
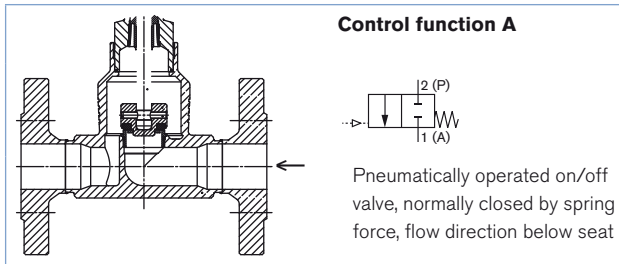

Orifice [mm]	Actuator size [mm]	K <sub>v</sub> value water [m <sup>3</sup> /h]	Minimum pilot pressure CFA [bar]	Operating pressure up to + 185 °C	
				CFA [bar]	On request :CFB [bar]
15	50	4.7	4.8	25	16
	70	4.7	4.8	25	16
20	50	8.1	4.8	16	16
	70	8.1	4.8	20	16
25	50	13	4.8	9	14.5
	70	13	4.8	16	16
32	70	19.5	4.8	8.5	16
	90	19.5	5.0	16	16
40	70	31	4.8	6	16
	90	31	5.0	16	16
50	70	45	-	-	16
	90	45	5.0	10	16
	130	45	5.0	16	-
65	90	73	5.0	5	14
	130	73	5.6	16 (15*)	16 (15*)
80	130	110	5.6	10	11
100	130	165	5.6	6	7

Flow rate: K<sub>v</sub> value water [m<sup>3</sup>/h]: Measured at +20 °C, 1 bar pressure at valve inlet and free outlet.

Pressure valves [bar]: Overpressure to the atmospheric pressure

\* acc. to the Pressure Equipment Directive 97/23 / EC for compressible fluids in Group 1 (hazardous gases and vapors in accordance with Article 3, Section 1.3, letter a, first dash)

On request control function B

Pressure charts with control function B and flow direction below the seat

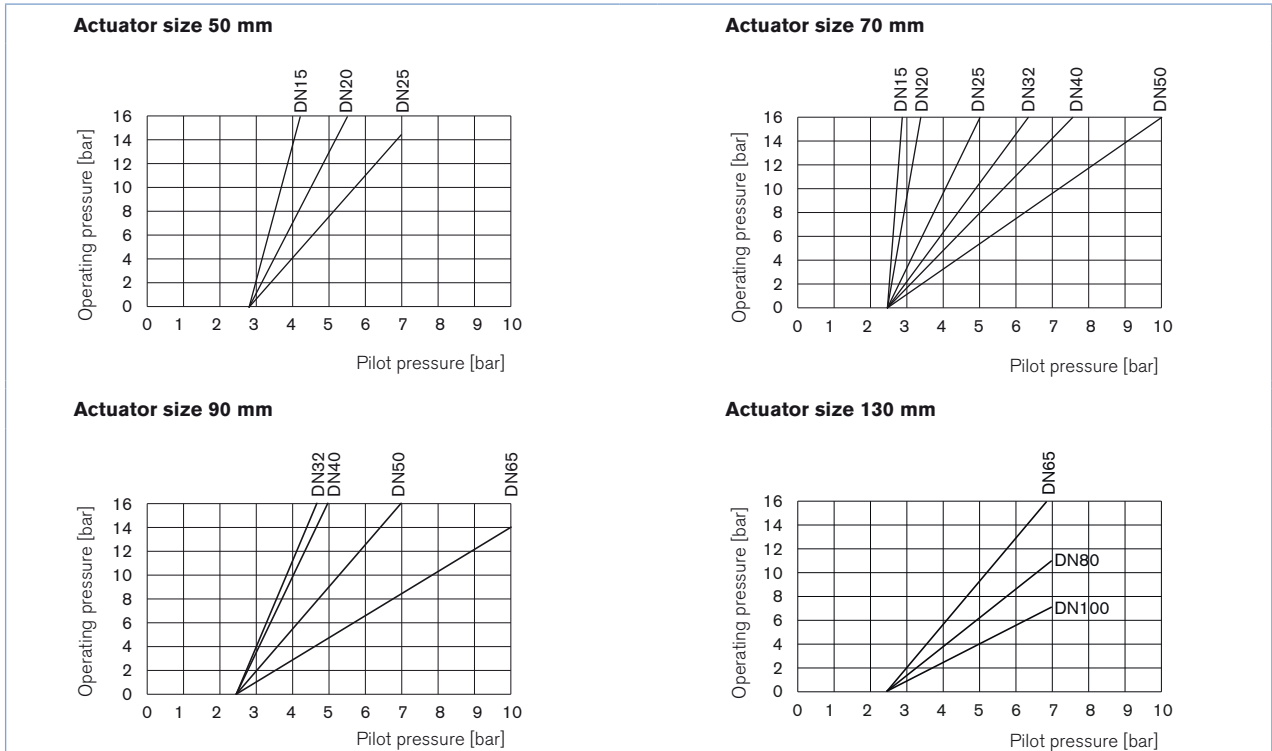

## Ordering chart Type 2101, flow direction below the seat (for gases and liquids)

## Flange connection acc. to DIN EN 1092-1, flow direction below the seat

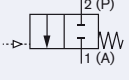
Control function	Orifice (mm)	Actuator size Ø [mm]	Minimum pilot pressure [bar]	Operating pressure up to +185 °C [bar]	Article no.	Article no. certified Atex II 2GD Mechanical
<b>A</b> 2/2 way valve. NC 	15	50	5.2	25	203076	260092
	20	50	5.2	16	203077	260093
		70	4.8	20	203078	260094
		50	5.2	9	203079	260095
	25	70	4.8	16	189700	260096
		70	4.8	8.5	203080	260099
	40	70	4.8	6	203082	260101
		90	5.0	16	203081	260100
	50	90	5.0	10	203084	260104
		130	5.0	16	203083	260103
	65	90	5.0	5	218418	260106
		130	5.6	16 (15*)	239524	260107
	80	130	5.6	10	219533	260109
		130	5.6	10	239528	260110
100	130	5.6	6	239531	260144	

## Flange connection acc. to ANSI B16.5, flow direction below the seat

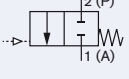
Control function	Orifice (mm)	Actuator size Ø [mm]	Minimum pilot pressure [bar]	Operating pressure up to +185 °C [bar]	Article no.
<b>A</b> 2/2 way valve. NC 	15	50	5.2	25	203095
	20	50	5.2	16	203096
		70	4.8	20	203097
		50	5.2	9	203098
	25	70	4.8	16	203099
		70	4.8	6	203100
	40	90	5.0	16	203101
		90	5.0	10	203102
	50	130	5.0	16	218419
		90	5.0	5	239525
	65	130	5.6	16 (15*)	239527
		130	5.6	10	239529
	80	130	5.6	6	239532
	100	130	5.6	6	239532

## Flange connection acc. to JIS 10K, flow direction below the seat

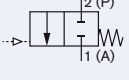
Control function	Orifice (mm)	Actuator size Ø [mm]	Minimum pilot pressure [bar]	Operating pressure up to +185 °C [bar]	Article no.
<b>A</b> 2/2 way valve. NC 	15	50	5.2	25	203111
	20	50	5.2	16	203112
		70	4.8	20	203113
		50	5.2	9	203114
	25	70	4.8	16	203115
		70	4.8	6	203118
	40	90	5.0	16	203121
		90	5.0	10	203122
	50	130	5.0	16	218471
		90	5.0	5	239526
	65	130	5.6	16 (15*)	219537
		130	5.6	10	239530
	80	130	5.6	6	239533
	100	130	5.6	6	239533

\* acc. to the Pressure Equipment Directive 97/23 / EC for compressible fluids in Group 1 (hazardous gases and vapors in accordance with Article 3, Section 1.3, letter a, first dash)

**i** Further versions on request

**Control function**  
B (normally open) and I (double-acting)

**Port connection**  
Welded and threaded ports

Technical data globe valve Type 2101 flow direction above the seat (for gases and steam)

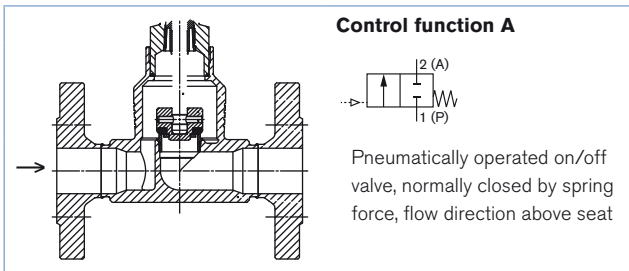

**Attention!**

Valves with flow above the seat are only conditionally usable for liquid medium. There is a danger of waterhammer!

Orifice [mm]	Actuator size [mm]	K <sub>v</sub> value water (m <sup>3</sup> /h)	Operating pressure up to + 185 °C CFA [bar]
15	50	4.7	16
	70	4.7	16
20	50	8.1	16
	70	8.1	16
25	50	13	16
	70	13	16
32	70	19.5	16
40	70	31	16
	90	31	16
50	70	45	12
	90	45	16





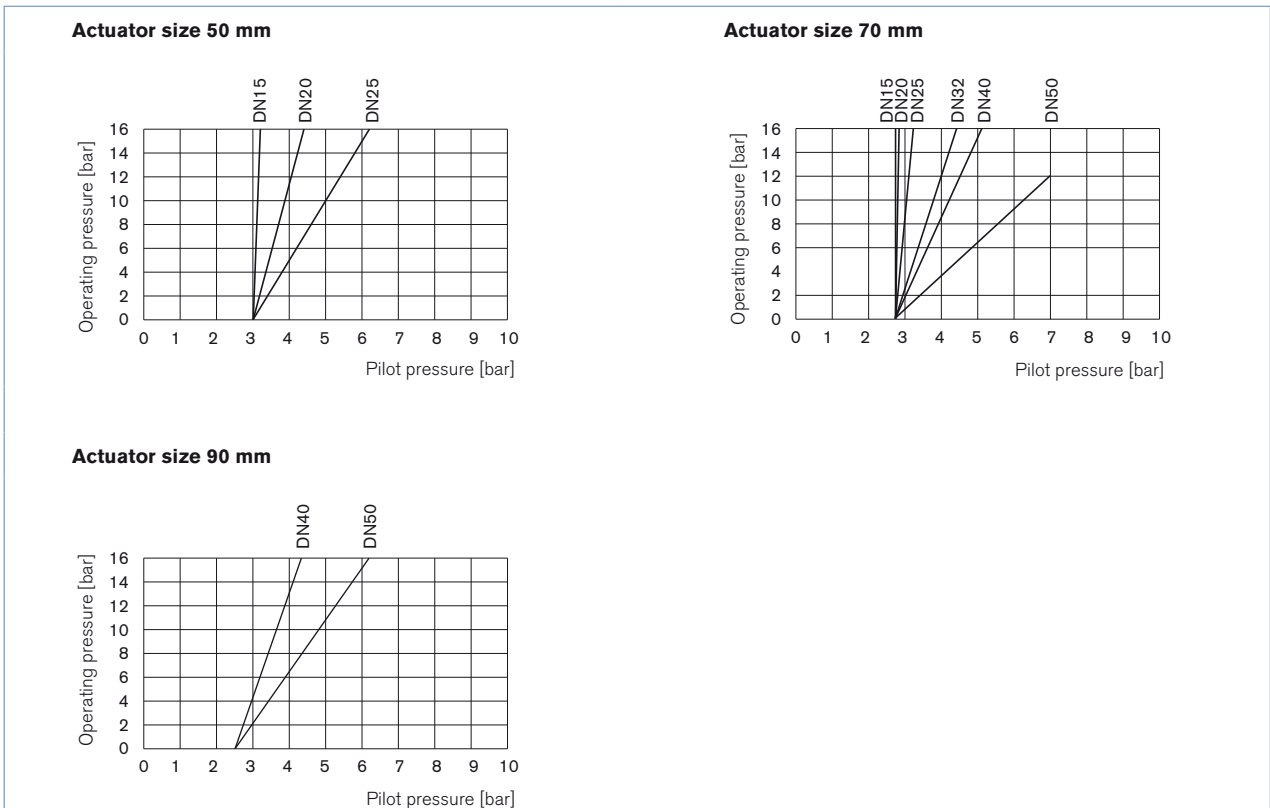





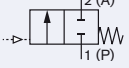



**Flow rate:** K<sub>v</sub> value water [m<sup>3</sup>/h]: Measured at + 20 °C, 1 bar pressure at valve inlet and free outlet.  
**Pressure valves [bar]:** Overpressure to the atmospheric pressure

Pressure charts with control function A and flow direction above the seat









## Ordering chart Type 2101 flow direction above the seat (for gases and steam)

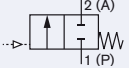





### Flange connection acc. to DIN EN 1092-1, flow direction above the seat

Control function	Orifice (mm)	Actuator size Ø [mm]	Minimum pilot pressure [bar]	Operating pressure up to + 185 °C [bar]	Article no.	Article no. certified Teach II 2GD Mechanical
<b>A</b> 2/2 way valve. NC 	15	50	see chart on p. 4	16	203086 	260145 
	20	50		16	203087 	260146 
	25	50		16	203088 	260151 
	32	70		16	203091 	260153 
	40	70		16	203092 	260154 
	50	70		12	204973 	260157 
		90		16	203094 	260158 

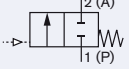
### Flange connection acc. to ANSI B16.5, flow direction above the seat

Control function	Orifice (mm)	Actuator size Ø [mm]	Minimum pilot pressure [bar]	Operating pressure up to + 185 °C [bar]	Article no.
<b>A</b> 2/2 way valve. NC 	15	50	see chart on p. 4	16	203103 
	20	50		16	203104 
	25	50		16	203105 
	40	70		16	203107 
	50	70		12	204974 
		90		16	203109 

### Flange connection acc. to JIS 10K, flow direction above the seat

Control function	Orifice (mm)	Actuator size Ø [mm]	Minimum pilot pressure [bar]	Operating pressure up to + 185 °C [bar]	Article no.
<b>A</b> 2/2 way valve. NC 	15	50	see chart on p. 4	16	203123 
	20	50		16	203124 
	25	50		16	203125 
	40	70		16	203127 
	50	70		12	204975 
		90		16	203129 

#### Further versions on request



#### Control function

B (normally open) and I (double-acting)



#### Port connection

Welded and threaded ports

## Materials globe valve Type 2101

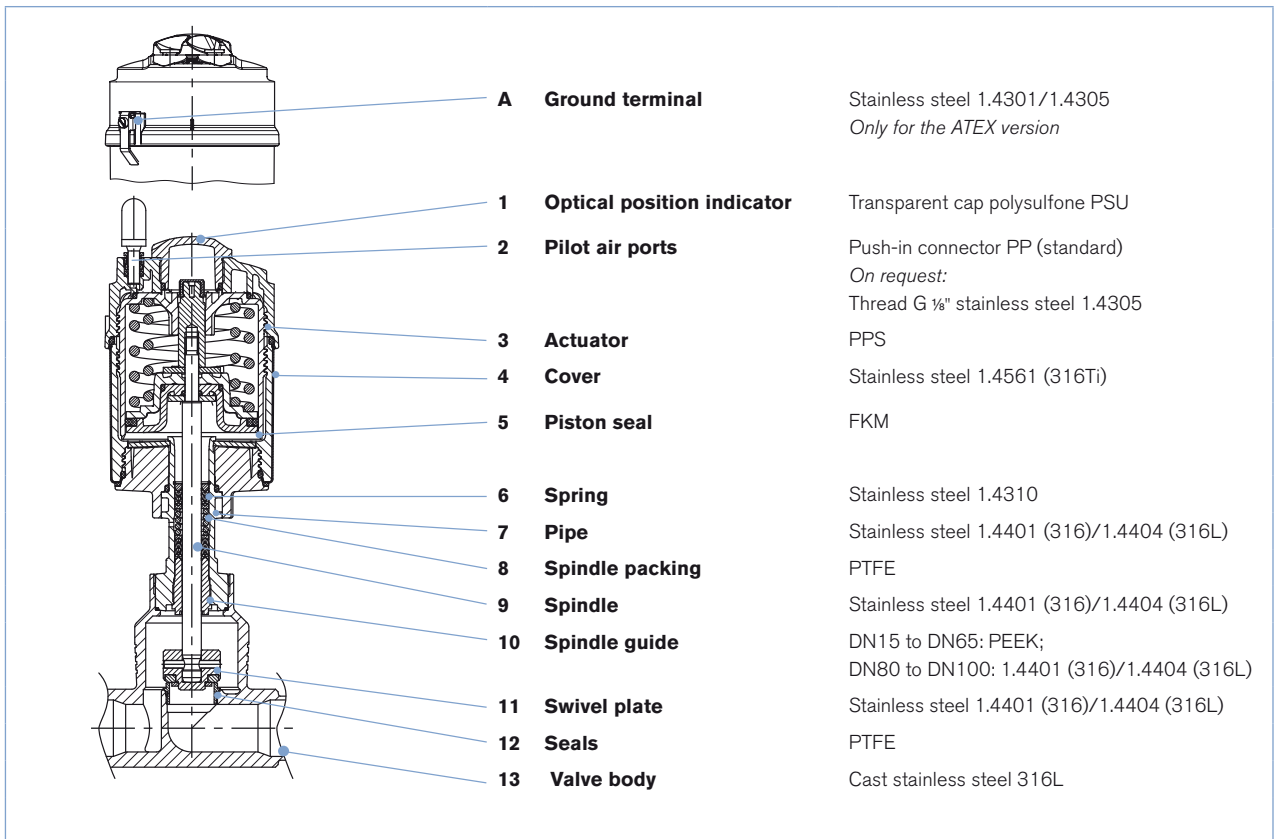

Lubricants for spindle packing and actuator are classified according NSF H1



Dimensions globe valve Type 2101 [mm]

Flanged body

Hose connection for  
6/4 mm plastic tube or  
G 1/8" connection

to determine the base measurements  
for the mounting version

Actuator size (Ø)	K
D (50)	9.7
M (70)	11
N (90)	11
P (130)	11

		Version
rotated	√ Rz = 160 min. Rz = 40	DIN
rotated	√ Rz = 160 min. Rz = 100	JIS
	Ra = 1.6	ANSI
	√ 50 grooves / in R = 0.06	

Orifice	Actuator size	All bodies					Flange acc. to DIN EN 1092-1, FTF acc. to EN558-1 Series 1					Flange acc. to JIS 10K, FTF acc. to EN558-2 Series 20									
		ØA	B	C	R	H	ØDF	LF	ØBF	AF	ØD	Axα	ØM	ØDF	LF	ØBF	AF	ØD	Axα	ØM	
15	50	64.5	6	19.8	19.8	236	90	130	60	16	14	4 × 90°	13.6	-	-	-	-	-	-	-	-
	70	91	8.5	23.3	30.5	250															
15	50	64.5	6	19.8	19.8	236	95	130	65	16	14	4 × 90°	18.1	95	108	70	12	15	4 × 90°	18.1	
	70	91	8.5	23.3	30.5	250															
20	50	64.5	6	19.8	19.8	242	105	150	75	18	14	4 × 90°	23.7	100	117	75	14	15	4 × 90°	23.7	
	70	91	8.5	23.3	30.5	256															
25	50	64.5	6	19.8	19.8	245	115	160	85	18	14	4 × 90°	29.7	125	127	90	14	19	4 × 90°	29.7	
	70	91	8.5	23.3	30.5	259															
32	70	91	8.5	23.3	30.5	280	140	180	100	18	18	4 × 90°	38.4	135	140	100	16	19	4 × 90°	38.4	
	90	120	8.5	23.3	30.5	340															
40	70	91	8.5	23.3	30.5	285	150	200	110	18	18	4 × 90°	44.3	140	165	105	16	19	4 × 90°	44.3	
	90	120	8.5	23.3	30.5	345															
50	130	159	8.5	23.3	30.5	397	165	230	125	20	18	4 × 90°	56.3	155	203	120	16	19	4 × 90°	56.3	
	70	91	8.5	23.3	30.5	295															
65	90	120	8.5	23.3	30.5	379	185	290	145	22	18	8 × 45°	66	175	216	140	18	19	4 × 90°	72	
	130	159	8.5	23.3	30.5	432															
80	130	159	8.5	23.3	30.5	465	200	310	160	24	18	8 × 45°	81	185	241	150	18	19	4 × 90°	84	
	100	130	159	8.5	23.3	30.5															475
100	130	159	8.5	23.3	30.5	475	235	350	190	24	22	8 × 45°	100	210	292	175	18	19	8 × 45°	109	

Orifice [inch]	Actuator size [mm]	All bodies					Flange acc. to ANSI B16.5, FTF acc. to EN558-2 Series 37						
		ØA	B	C	R	H	ØDF	LF	ØBF	AF	ØD	Axα	ØM
1/2"	50	64.5	6	19.8	19.8	236	89	184	60.5	11.2	15.7	4 × 90°	15.7
	70	91	8.5	23.3	30.5	250							
3/4"	50	64.5	6	19.8	19.8	242	99	184	69.9	12.7	15.7	4 × 90°	20.8
	70	91	8.5	23.3	30.5	256							
1"	50	64.5	6	19.8	19.8	245	108	184	79.2	14.2	15.7	4 × 90°	26.7
	70	91	8.5	23.3	30.5	259							
1 1/2"	90	120	8.5	23.3	30.5	345	127	222	98.6	17.5	15.7	4 × 90°	40.9
	130	159	8.5	23.3	30.5	397							
2"	70	91	8.5	23.3	30.5	295	152	254	120.7	19.1	19.1	4 × 90°	52.6
	90	120	8.5	23.3	30.5	351							
2 1/2"	130	159	8.5	23.3	30.5	432	178	276	139.7	22.3	19.1	4 × 90°	63
	90	120	8.5	23.3	30.5	379							
3"	130	159	8.5	23.3	30.5	465	190	298	152.4	23.9	19.1	4 × 90°	78
	100	130	159	8.5	23.3	30.5							
4"	130	159	8.5	23.3	30.5	475	229	352	190.5	23.9	19.1	8 × 45°	102

Dimensions globe valve Type 2101 [mm], *continued*

Threaded body

Hose connection for  
6/4 mm plastic tube or  
G 1/8" connection

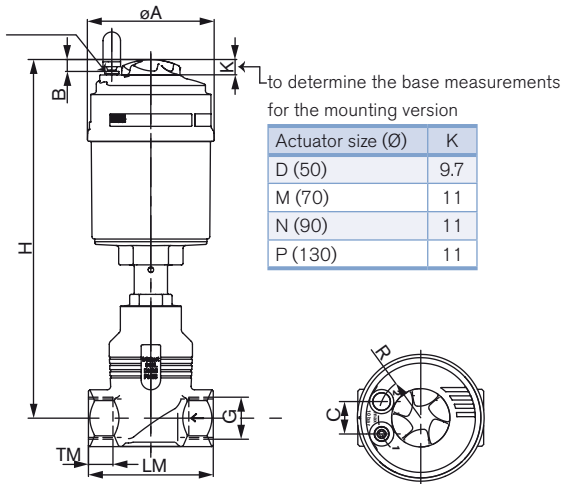

Orifice	Actuator size	All bodies					LM	G		NPT		Rc	
		ØA	B	C	R	H		G	TM	G	TM	G	TM
15	50	64.5	6	19.8	19.8	236	65	G 3/8"	12	NPT 3/8"	10.3	Rc 3/8"	10.1
	70	91	8.5	23.3	30.5	250							
15	50	64.5	6	19.8	19.8	236	65	G 1/2"	14	NPT 1/2"	13.7	Rc 1/2"	13.2
	70	91	8.5	23.3	30.5	250							
20	50	64.5	6	19.8	19.8	242	75	G 3/4"	16	NPT 3/4"	14	Rc 3/4"	14.5
	70	91	8.5	23.3	30.5	256							
25	50	64.5	6	19.8	19.8	245	90	G 1"	18	NPT 1"	16.8	Rc 1"	16.8
	70	91	8.5	23.3	30.5	259							
32	70	91	8.5	23.3	30.5	280	110	G 1 1/4	20	NPT 1 1/4	17.3	Rc 1 1/4"	19.1
	90	120	8.5	23.3	30.5	340							
	70	91	8.5	23.3	30.5	285							
40	90	120	8.5	23.3	30.5	345	120	G 1 1/2	22	NPT 1 1/2	17.3	Rc 1 1/2"	19.1
	130	159	8.5	23.3	30.5	397							
	70	91	8.5	23.3	30.5	295							
50	90	120	8.5	23.3	30.5	351	150	G 2"	24	NPT 2"	17.6	Rc 2"	23.4
	130	159	8.5	23.3	30.5	403							
	70	91	8.5	23.3	30.5	295							
65	90	120	8.5	23.3	30.5	379	185	G 2 1/2	26	NPT 2 1/2	23.7	Rc 2 1/2"	26.7
	130	159	8.5	23.3	30.5	432							

Dimensions globe valve Type 2101 [mm], *continued*

Weld end body

Hose connection for  
6/4 mm plastic tube or  
G 1/8" connection

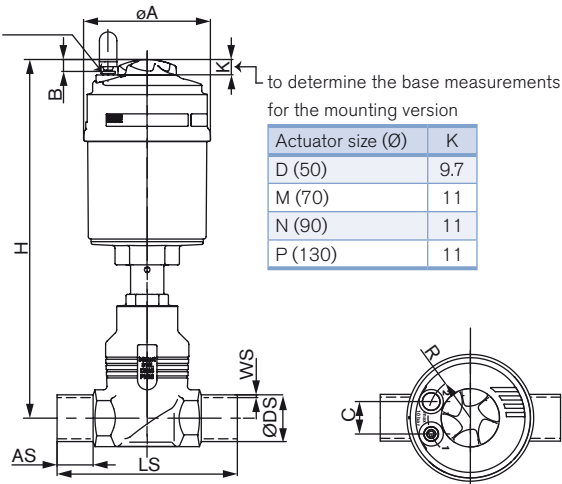

Orifice size	Actuator size	All bodies						ISO 4200		DIN 11850 R2		
		ØA	B	C	R	H	AS	LS	Ø DS	WS	Ø DS	WS
15	50	64.5	6	19.8	19.8	236	20	90	17.2	1.6	13	1.5
	70	91	8.5	23.3	30.5	250						
15	50	64.5	6	19.8	19.8	236	20	90	21.3	1.6	19	1.5
	70	91	8.5	23.3	30.5	250						
20	50	64.5	6	19.8	19.8	242	20	10	26.9	1.6	23	1.5
	70	91	8.5	23.3	30.5	256						
25	50	64.5	6	19.8	19.8	245	26	130	33.7	2.0	29	1.5
	70	91	8.5	23.3	30.5	259						
32	70	91	8.5	23.3	30.5	280	26	140	42.4	2.0	35	1.5
	90	120	8.5	23.3	30.5	340						
	70	91	8.5	23.3	30.5	285						
40	90	120	8.5	23.3	30.5	345	26	150	48.3	2.0	41	1.5
	130	159	8.5	23.3	30.5	397						
	70	91	8.5	23.3	30.5	295						
50	90	120	8.5	23.3	30.5	351	26	175	60.3	2.0	53	1.5
	130	159	8.5	23.3	30.5	403						
	90	120	8.5	23.3	30.5	379						
65	90	120	8.5	23.3	30.5	379	26	210	76.1	2.3	70	2.0
	130	159	8.5	23.3	30.5	432						

Orifice [inch]	Actuator size [mm]	All bodies						BS 4825 Part1		ASME BPE		
		ØA	B	C	R	H	AS	LS	Ø DS	WS	Ø DS	WS
1/2"	50	64.5	6	19.8	19.8	236	20	90	12.7	1.2	12.7	1.65
	70	91	8.5	23.3	30.5	250						
3/4"	50	64.5	6	19.8	19.8	242	20	90	19.05	1.2	19.05	1.65
	70	91	8.5	23.3	30.5	256						
1"	50	64.5	6	19.8	19.8	245	20	100	25.4	1.6	25.4	1.6
	70	91	8.5	23.3	30.5	259						
	70	91	8.5	23.3	30.5	285						
1 1/2"	90	120	8.5	23.3	30.5	345	26	140	38.1	1.6	38.1	1.6
	130	159	8.5	23.3	30.5	397						
	70	91	8.5	23.3	30.5	295						
2"	90	120	8.5	23.3	30.5	351	26	150	50.8	1.6	50.8	1.6
	130	159	8.5	23.3	30.5	403						
	90	120	8.5	23.3	30.5	379						
2 1/2"	90	120	8.5	23.3	30.5	379	26	175	63.5	1.6	63.5	1.6
	130	159	8.5	23.3	30.5	432						

Dimensions for valve system On/Off ELEMENT Type 8801-GC [mm]

Dimensions valve system On/Off ELEMENT Type 8801-GC-K (with pneumatic control unit Type 8690)

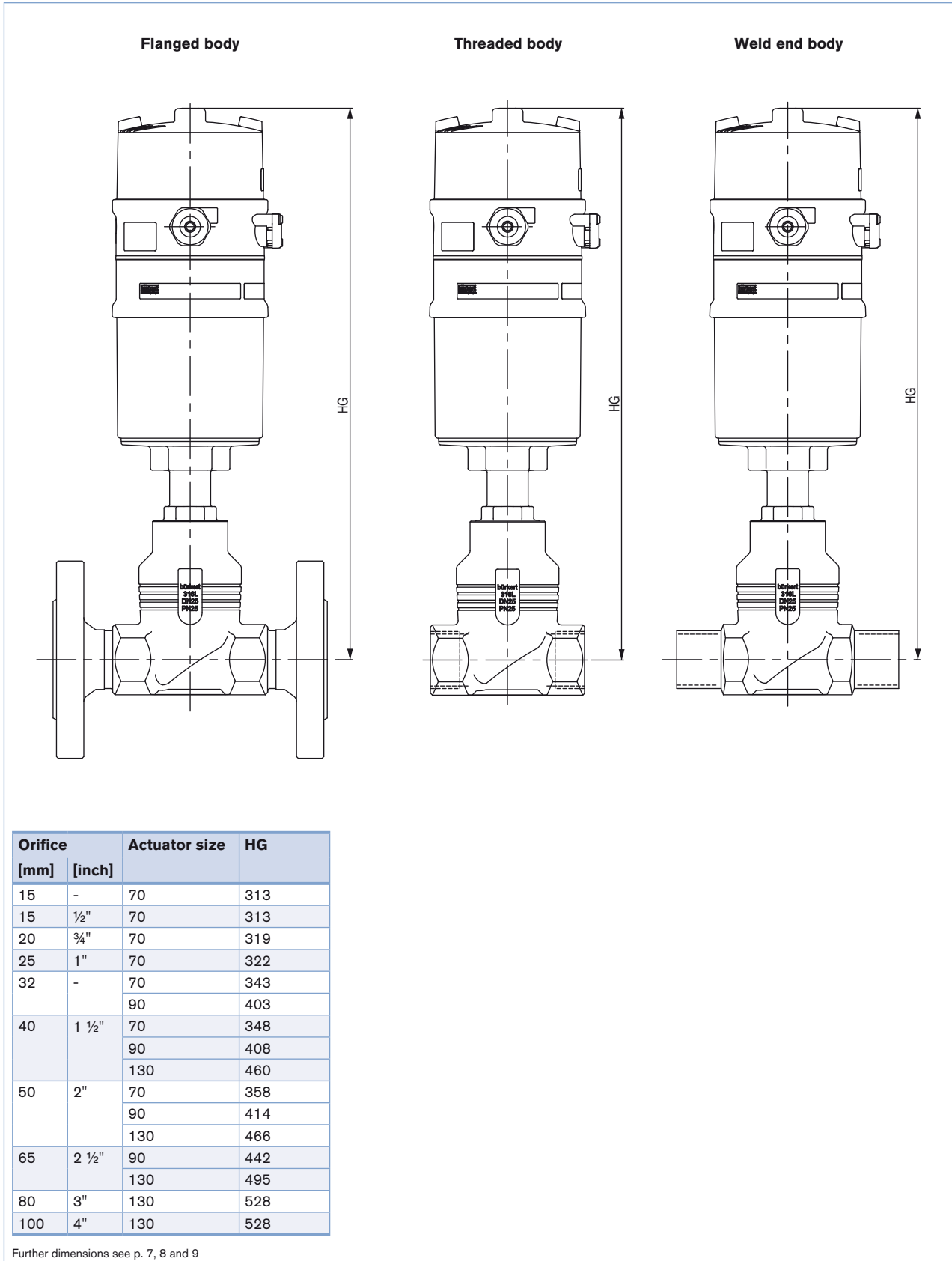

Dimensions for valve system On/Off ELEMENT Type 8801-GC [mm]

Dimensions valve system On/Off ELEMENT Type 8801-GC-H (with control head Type 8691)

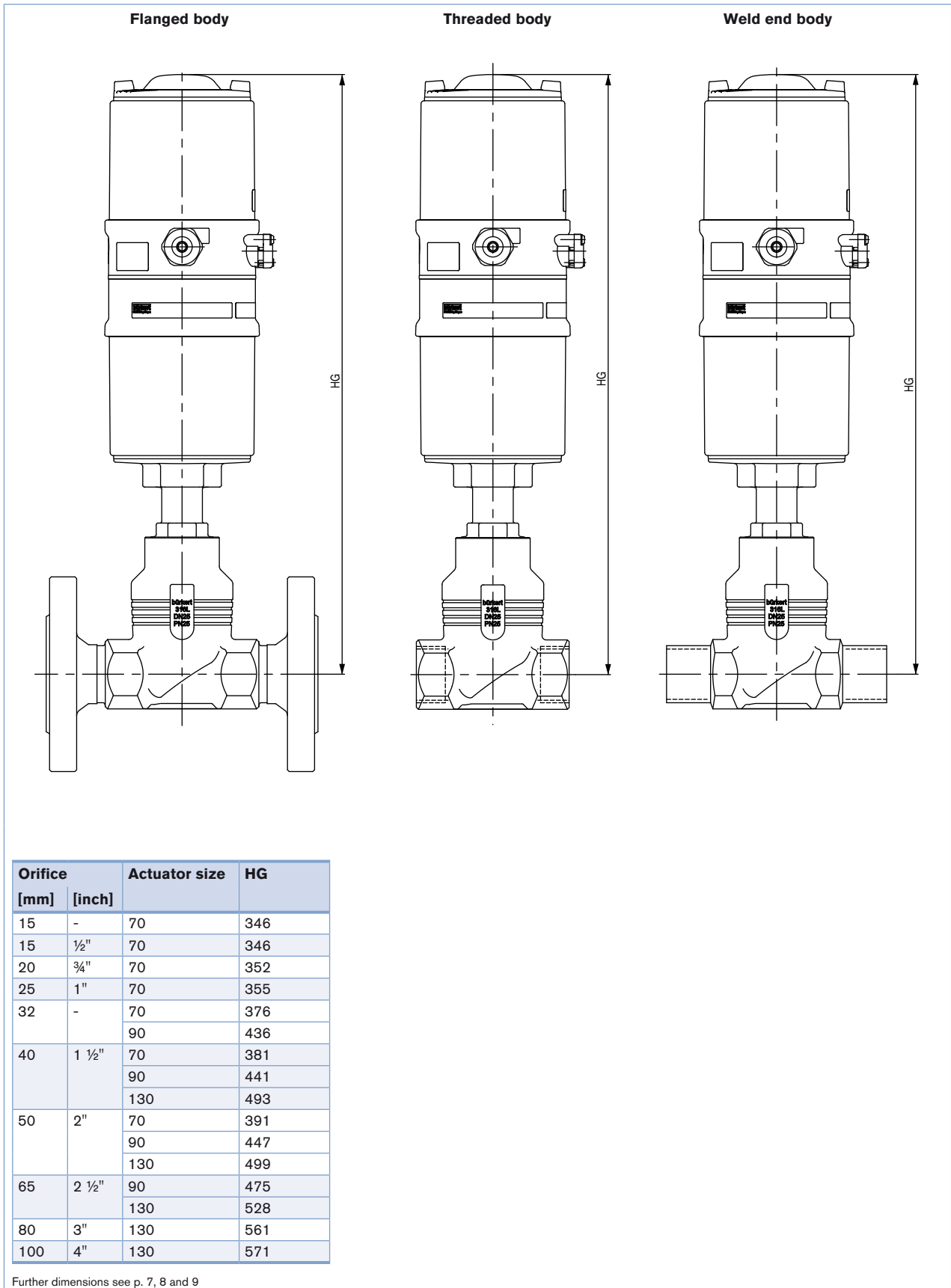

Further dimensions see p. 7, 8 and 9

Dimensions for valve system On/Off ELEMENT Type 8801-GC [mm]

Dimensions valve system On/Off ELEMENT Type 8801-GC-M (with control head Type 8695)

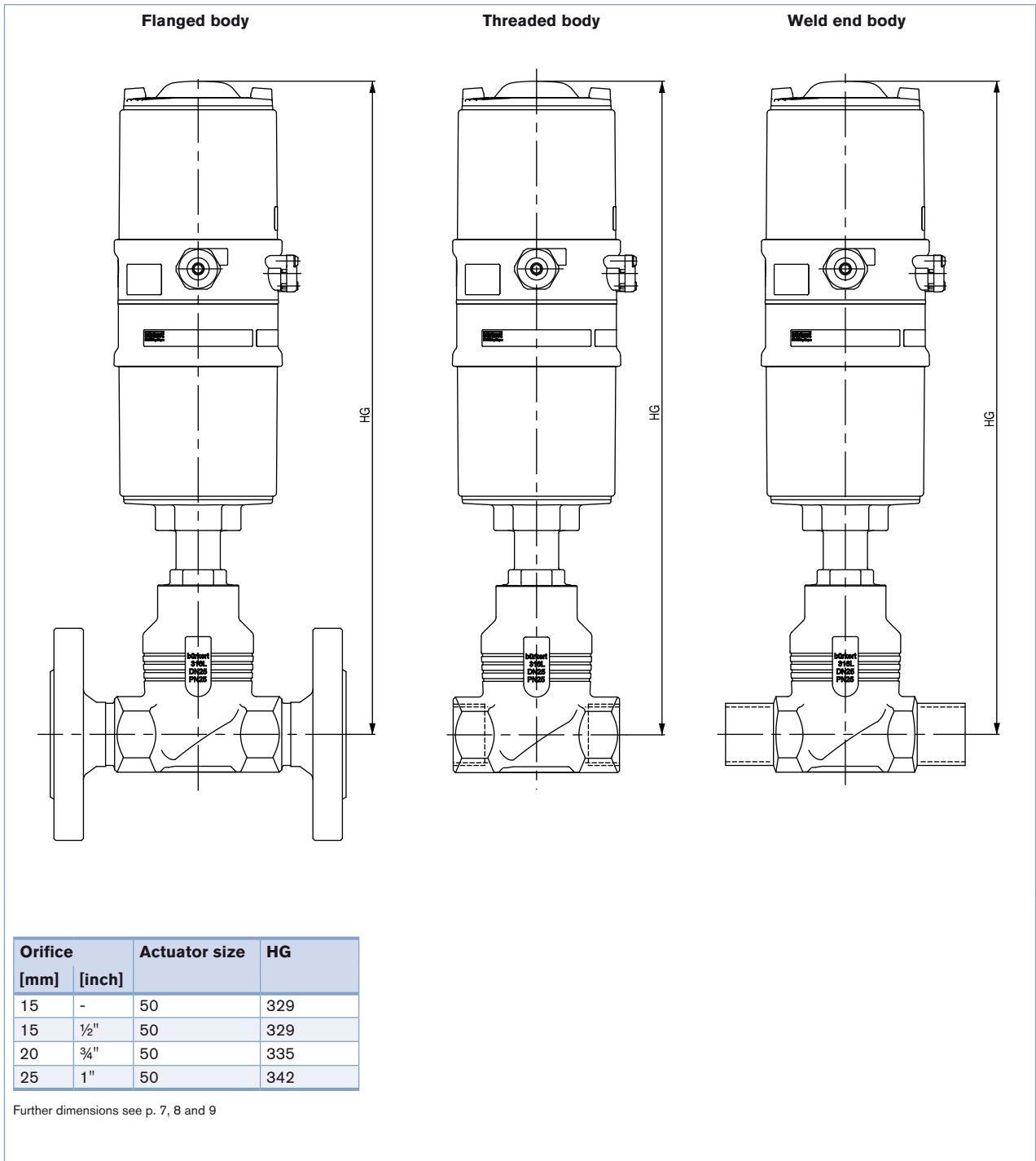

Dimensions for valve system On/Off ELEMENT Type 8801-GC [mm]

Dimensions valve system On/Off ELEMENT Type 8801-GC-U (with control head Type 8697)

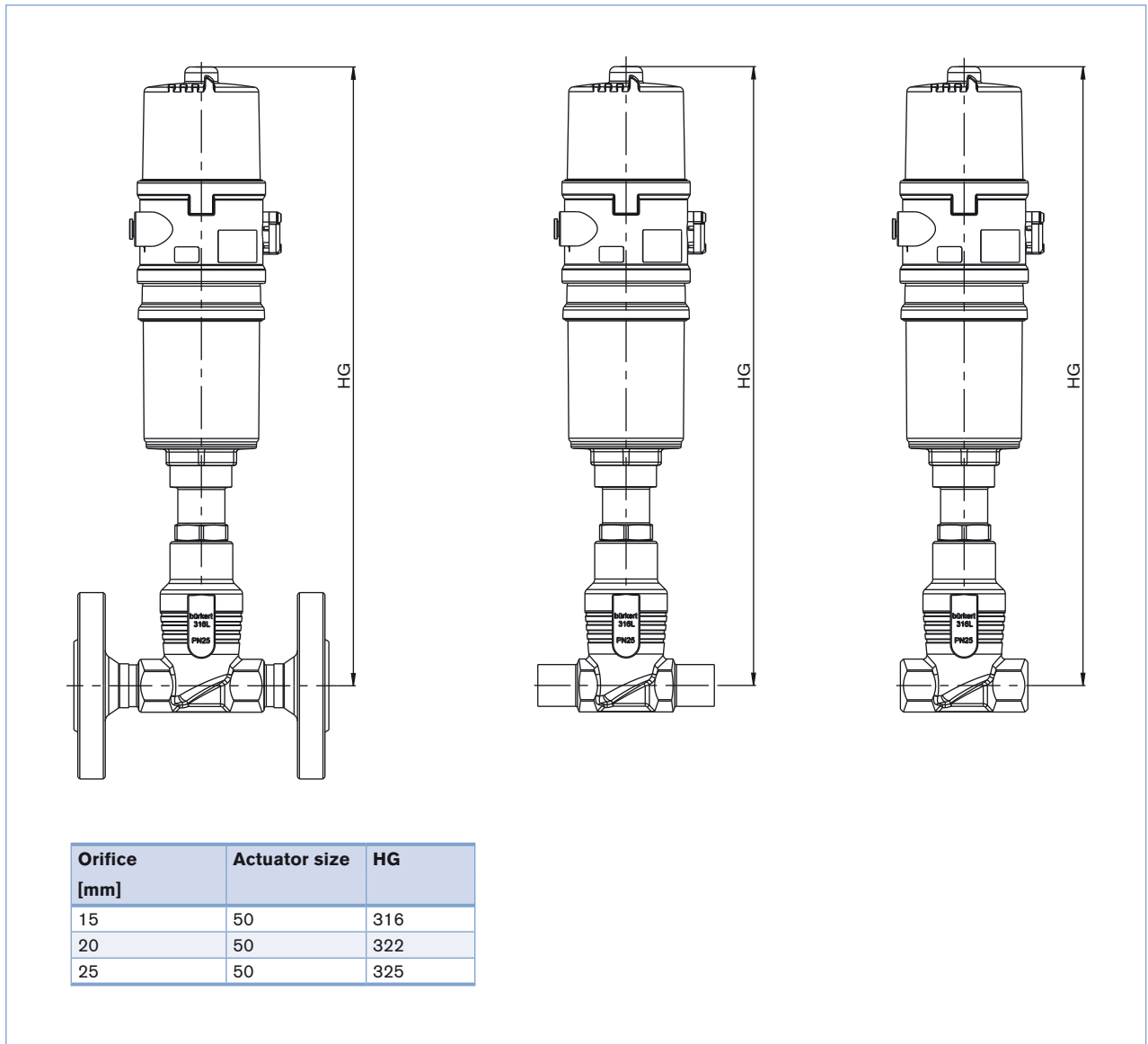

**Note**  
You can fill out the fields directly in the PDF file before printing out the form.

**Valve system On/Off ELEMENT Type 8801-GC – request for quotation**

▶ Please fill out and send to your nearest Bürkert facility\* with your inquiry or order

Company	Contact person
Customer no.	Department
Address	Tel./Fax
Postcode/town	E-Mail

= mandatory fields to fill out       Quantity       Required delivery date

**Operating data**

Pipe line DN  PN

Pipe material

Process medium

Type of media       Liquid       Steam       Gas

**Valve features**

Seal material       PTFE       NBR       Other

Nominal pressure PN

Orifice DN

Type of connection       Flanged       Threaded       Welded       Clamp

Standard connection       ISO       DIN       Other

Control function       NC<sup>1)</sup>       NO<sup>1)</sup>       Double-acting

Pilot pressure  min.       max.

Atex II 2GD Mechanical

Please specify item no. (if known):

<sup>1)</sup>NC: normally closed by spring action; NO: normally open by spring action









**Continued on next page →**



Valve system On/Off ELEMENT Type 8801-GC – request for quotation, *continued*

**Automation unit features**

Click on the orange box "More info"... you will come to our website for the resp. product where you can download the data sheet.

Control Head		Pneumatic Control Unit / Feedback	
<input type="checkbox"/> <b>Type 8691</b>  For actuator size Ø 70/90/130 mm 	<input type="checkbox"/> <b>Type 8695</b>  For actuator size Ø 50 mm 	<input type="checkbox"/> <b>Type 8690</b>  For actuator size Ø 70/90/130 mm 	<input type="checkbox"/> <b>Type 8697</b>  For actuator size Ø 50 mm 
<ul style="list-style-type: none"> <li>Inductive position sensor with automatic Teach function</li> <li>Coloured high power LEDs</li> <li>With/without pilot valve for single or double-acting actuators</li> <li>Fieldbus communication</li> <li>Hygienic stainless steel design</li> </ul>		<ul style="list-style-type: none"> <li>visual status indicator</li> <li>Micro- or proximity switches for end position feedback</li> <li>With/ without pilot valve for single or double-acting actuators</li> <li>Optional intrinsically safe version acc. to ATEX / IECEx</li> </ul>	
<b>Pneumatic function</b> <input type="checkbox"/> Single-acting <input type="checkbox"/> Double-acting <input type="checkbox"/> Without pilot valve	<b>Electrical connection</b> <input type="checkbox"/> Cable gland <input type="checkbox"/> M12 connector	<b>Pneumatic function</b> <input type="checkbox"/> Single-acting <input type="checkbox"/> Double-acting (only with 8690) <input type="checkbox"/> Without pilot valve	<b>Number of Position feedback switches</b> <input type="checkbox"/> 1x <input type="checkbox"/> 2x
<b>Communication</b> <input type="checkbox"/> AS-Interface <input type="checkbox"/> DeviceNet <input type="checkbox"/> without	<b>Approvals</b> <input type="checkbox"/> ATEX cat. 3GD, IECEx <input type="checkbox"/> without	<b>Position feedback switches</b> <input type="checkbox"/> Micro-switch 24 V DC <input type="checkbox"/> Micro-switchr 50 – 225 V DC/AC (only 8697) <input type="checkbox"/> Inductive switch 3-wire PNP <input type="checkbox"/> Inductive switch 2-wire NAMUR <input type="checkbox"/> Inductive switch 2-wire 24 V DC <input type="checkbox"/> without	<b>Electrical connection</b> <input type="checkbox"/> Cable gland <input type="checkbox"/> M12 connector
		<b>Approvals</b> <input type="checkbox"/> ATEX cat. 3GD, IECEx <input type="checkbox"/> ATEX cat. 2DG, IECEx <input type="checkbox"/> without	

**Certifications**

- Attestation of compliance with the order EN-ISO 10204 2.1 (Article no. 440788)
- Test report EN-ISO 10204 2.2 (Article no. 803722)
- Certification of Conformity for Raw Material EN-ISO 10204 3.1 (Included in delivery)
- EN161 (European Gas Device guideline)
- FDA and USP compliance

**Comment /sketch**

To find your nearest Bürkert facility, click on the orange box → [www.burkert.com](http://www.burkert.com)

In case of special application conditions, please consult for advice.

Subject to alteration.  
© Christian Bürkert GmbH & Co. KG

1801/16\_EU-en\_00895100

DTS 1000112108 EN Version: P Status: RL (released | freigegeben | valide) printed: 16.01.2018