

ABS light wastewater pump MF 154-804

Compact submersible pumps with large solids passage for the reliable and effective dewatering of buildings and sites in accordance with EN 12050-2.



Applications

MF submersible pumps have been designed to cover a wide range of internal and external dewatering applications.

- Filling and emptying of containers to the drainage of flooded cellars and removal of rainwater.
- Suitable for use in septic tanks and pumping effluent from locations below the backwash level in accordance with EN 12056.
- For locations such as building sites, the MF 354, MF 504 & MF 804 are available in a VO version, featuring a protective screen, elbow and hose coupling.
- The vortex hydraulics are particularly suitable for the pumping of fluids containing gaseous or abrasive particles.
- The compact shape of the MF, fittings for easy mounting, and small sump requirements ensure a quick and cost-effective installation of the pump.
- Maximum allowable temperature is 40 °C for continuous use or up to 60 °C for intermittent (max. 5 minutes).



Construction

The water-tight, fully flood-proof cast iron motor and the hydraulics section comprise a compact, robust, unit construction.

Motor

Three-phase 400 V and single-phase 220-240 V, 50 Hz, 2-pole (2900 r/min) motors. Insulation class F; protection type IP68.

Bearings

The stainless steel rotor shaft is supported in lubricated-for-life ball bearings.

Shaft sealing

Between motor and hydraulic section by means of a high quality mechanical seal of carbon / silicon carbide on MF 154-334 and silicon carbide on MF 354-804. Seal at motor side is an oil-lubricated lip seal. Both are independent of direction of rotation and resistant to temperature shock.

Temperature monitoring

TCS (Thermo-Control-System) with thermal sensors in the stator to switch off the pump in the case of overheating and switch on automatically after cooling down.

Hydraulic section with vortex impeller

Free solids passage 20 mm (MF 154), 30 mm (MF 324 & 334), 40 mm (MF 354, 404, 504, 804) and 60 mm (MF 565 & 665).

Features

- Simple, cost-effective, pump installation.
- Vortex hydraulics for blockage-free pumping in critical applications.
- Free-standing on legs or pedestal mounted.
- Discharge connections G 1¼"-G 2" internal thread and DN 65 flange.
- Mechanical and lip seals on rotor shaft.
- Thermal sensors to protect motor against overheating.
- KS version with float switch for automatic level control.
- EasyFit plug-in cable connection.
- Single-phase fitted with Europlug; three-phase with CEE plug.

Materials

Description	Material
Upper Lid	Stainless steel 1.4301 (AISI 304)
Motor Housing	Cast iron EN-GJL-250
Rotor Shaft	Stainless steel 1.4021 (AISI 420)
Volute	Cast iron EN-GJL-250
Impeller	Polyamide
Cable	Neoprene
Fasteners	Stainless steel 1.4401 (AISI 316)

Technical Data

MF	154 W	324 W	334 D	354 W	404 D	504 W
Discharge connection*	G 1½" - 1¼"	G 1½" - 1¼"	G 1½" - 1¼"	G 2"	G 2"	G 2"
Motor power (kW)** P ₁	0.65	0.83	0.83	1.10	1.14	2.05
	P ₂ 0.42	0.54	0.56	0.70	0.80	1.45
Speed (r/min)	2900	2900	2900	2900	2900	2900
Rated voltage (V)	220-240 1~	220-240 1~	400 3~	220-240 1~	400 3~	220-240 1~
Rated current (A)	2.8	3.6	1.4	4.8	2.0	9.0
Cable type (H07RN-F)	F3G1.0	F3G1.0	F4G1.0	F3G1.0	F4G1.0	F3G1.0
Cable length (m)**	3, 10, 20, 30	3, 10, 20, 30	3, 10, 20, 30	3, 10, 20, 30	3, 10, 20, 30	3, 10, 20, 30
Weight (kg)	8.5	8.5	8.9	14.0	14.0	17.0
Solids size (mm)	20	30	30	40	40	40

MF	565 W	665 D	804 D	VO 354 W	VO 504 W	VO 804 D
Discharge connection*	DN 65	DN 65	G 2"	G 2" - C	G 2" - C	G 2" - C
Motor power (kW)** P ₁	2.6	2.6	2.40	1.14	2.05	2.40
	P ₂ 1.8	2.0	1.80	0.80	1.45	1.80
Speed (r/min)	2900	2900	2900	2900	2900	2900
Rated voltage (V)	220-240 1~	400 3~	400 3~	220-240 1~	220-240 1~	400 3~
Rated current (A)	11.6	4.6	4.1	4.8	9.0	4.1
Cable type (H07RN-F)	F3G1.0	F4G1.0	F4G1.0	F3G1.0	F3G1.0	F4G1.0
Cable length (m)***	3, 10, 20, 30	3, 10, 20, 30	3, 10, 20, 30	10, 20, 30	10, 20, 30	10, 20, 30
Weight (kg)	24.0	24.0	20.0	15.2	18.2	21.2
Solids size (mm)	60	60	40	40	40	40

* MF 154-504 and 804: internal threaded (154-334 with 1½" to 1¼" adaptor; MF VO with STORZ-C hose coupling on elbow).

MF 565 W and 665 D: flange.

** P₁ = Power taken from mains. P₂ = Power at motor shaft

*** 3 m only with KS pump. Not available on VO; according to VDE regulations submersible pumps for use externally must have a fixed cable connection with a length of at least 10 m. Regulations vary by country.

Performance Curves

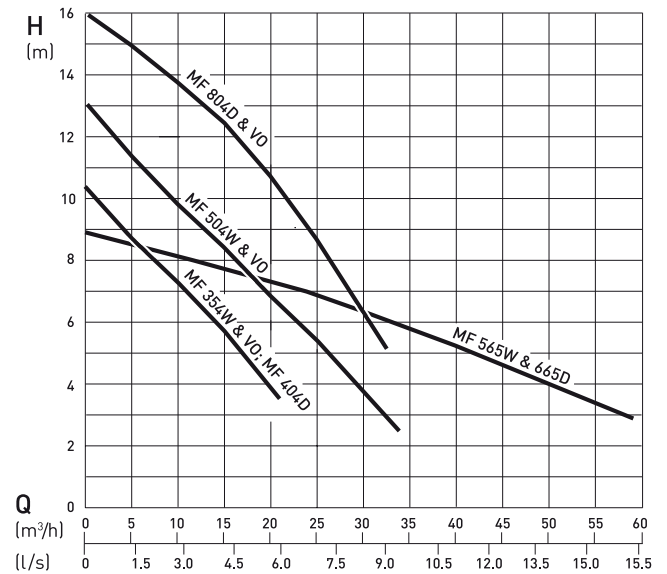
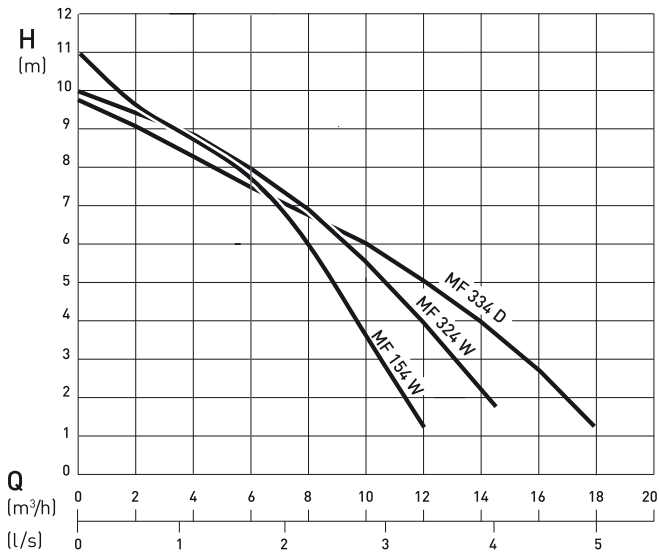

H = Total Head; Q = Discharge Volume. Curves to ISO 9906 (60 Hz available on request) N.B. please use the ABSEL program to validate pump selection.

Dimensions (mm)

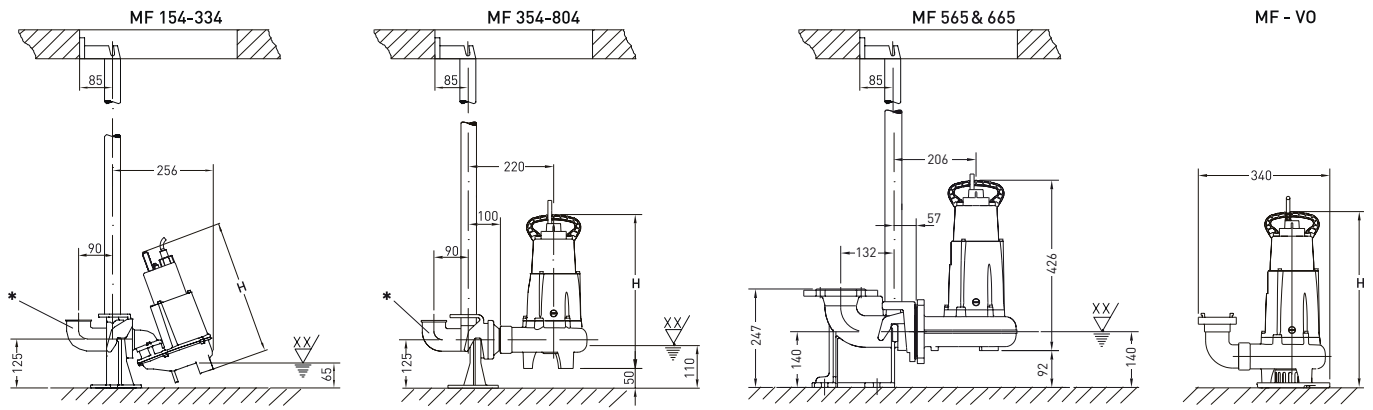

XX = Lowest switch off level. Minimum switch on level is at least 100 mm higher

* Elbow to be supplied by customer.

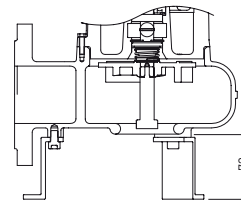
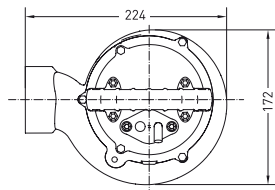
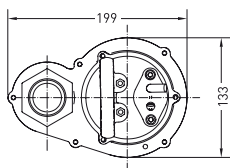

MF 565 and 665 with support legs

MF	H
154	333
324 & 334	350
354 & 404	400
504	425
804	450
354- VO	405
504- VO	430
804- VO	455

Installation

Attention to the backwash level is of vital importance for effective dewatering. All outflow points located below the backwash level must be protected against back flow according to standard EN 12056.

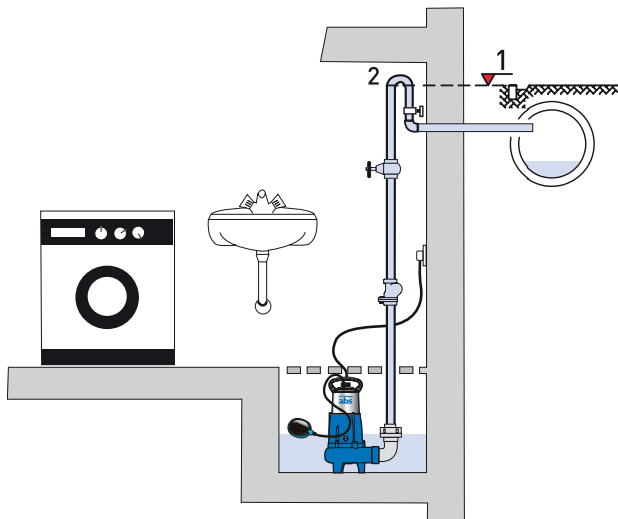

1. Backwash level
2. Backwash loop with base above the backwash level

EasyFit cable connector

Plug-in cable connection for simple replacement of damaged cable without disassembling the pump.



Accessories

	Description	Size	Part no.	MF
Fixed Installation	Pedestal (EN-GJL-250)			
	vertical discharge, without bend	G 1¼"/G 2"	62325012	154-334
	horizontal discharge, without bend	G 1¼"/G 2"	62325001	324 & 334
	horizontal discharge, without bend	G 2"/G 2"	62320560	354-804
	90° cast bend	DN 65	62320673	565 & 665
	Bracket Kit	G 1¼"/G 2"	62325014	154-334
	vertical discharge			
	Guide Rail (galvanized steel)	1¼" x 1 m	31380007	154-804
		1¼" x 2 m	31380008	154-804
		1¼" x 3 m	31380009	154-804
		1¼" x 4 m	31380010	154-804
		1¼" x 5 m	31380011	154-804
	Chain Kit (galvanized steel) including shackle	3 m	61265065	154-804
		4 m	61265093	154-804
		6 m	61265069	154-804
		7 m	61265096	154-804
	Chain Kit (stainless steel) including shackle	3 m	61265081	154-804
	4 m	61265099	154-804	
	6 m	61265085	154-804	
	7 m	61265102	154-804	
Transportable	Coupling Spanners (two required)	A-B-C	15010020	VO
	Support Legs Kit		61405015	565 & 665
Electrical (fixed installation)	Plug-in Alarm		16020201	154-804
	for DIN type socket 230 V with audible alarm. Alarm diode and cancel button, potential-free fault output, mains operated. Available also with loading unit for mains-independent operation.			
	NC-AKKU		12820018	154-804
	9 V rechargeable battery for mains-independent alarm			
	ABS Alarm Contact Float	KS 5 = 5 m	62450016	154-804
	with KS float switch	KS 10 = 10 m	62450017	154-804
(transportable)	ABS Control System			
	for duplex pumping stations in corrosion-resistant plastic housing with automatic change of the operating sequence, acoustic alarm and potential-free fault signal plus float switches. Contact ABS for details.			
	Automatic Level Control	Single phase: KS-Z 10	08410205	154-804
	with socket into which pump can be plugged without the need to do any wiring (for DIN plugs only)			
General	Non-return Valve (synthetic)	G 1¼"	61400511	154-334
	flap valve with internal thread	G 1½"	61400512	154-334
		G 2"	61400513	354-804
	Non-return Valve (EN-GJL-250)	G 1¼"	61400525	154-334
	ball valve with internal thread	G 1½"	61400526	154-334
		G 2"	61400527	354-804
		G 2½"	61400543	565 & 665
	Gate Valve (brass)	G 1¼"	14040005	154-334
	with internal thread	G 1½"	14040006	154-334
		G 2"	14040007	354-804