

PLAY VALUE

- jumping*
- meeting*
- sliding*
- climbing*



OTHER INFORMATION



8 players

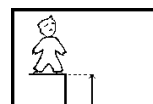

HCL= 2.1m

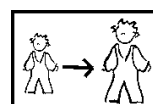

7-14 years old

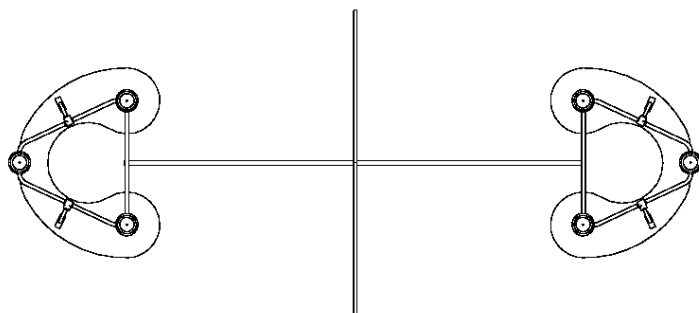

Installation of equipment

Impact area = minimum safety surfacing required according to EN 1176-1/ EN 1177

-  Impact area
-  Free space

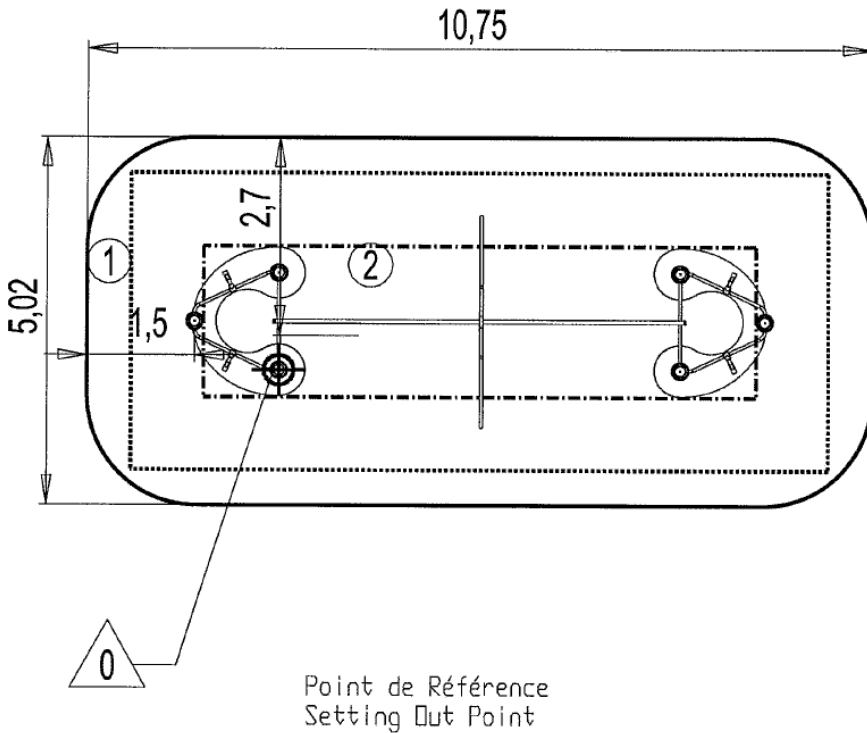

Point de Référence
Setting Out Point
Punto de referencia
Bezugspunkt

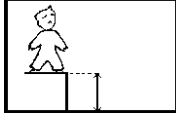
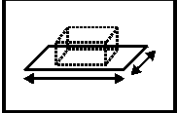
		
①	1,00m	13.5m ²
②	2,10m	39m ²

INSTALLATION

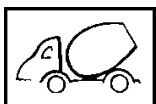

0.4m³



2

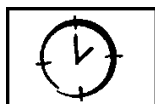

10H00

CERTIFICATIONS

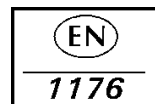

V 4 - 2007-01-01