

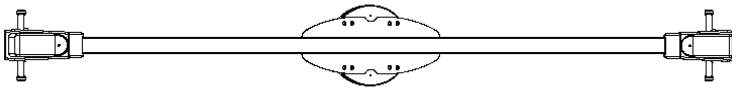

1=3.83m 2=0.86m 3=3.24m

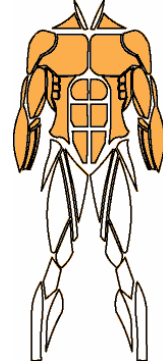

MUSCULAR STIMULATION



INTENSITY OF EFFORT



ENERGY EXPENDITURE

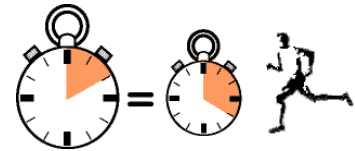

DIMENSIONS & MOVEMENTS

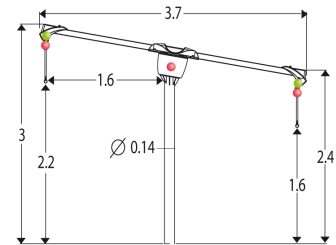

OTHER INFORMATION



2 players

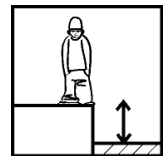

HCL= 0.9m

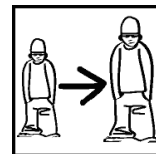

12+

Installation of equipment

Impact area = minimum safety surfacing required according to EN 1176-1/ EN 1177

———— Impact area

- - - - - Free space

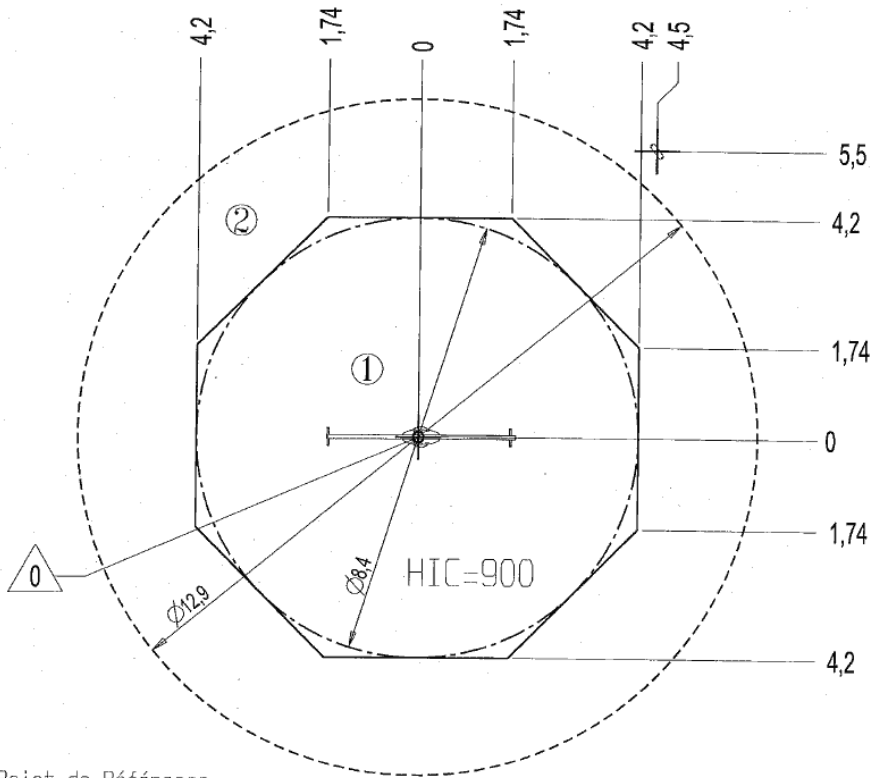

Point de Référence
Setting Out Point
Punto de referencia
Bezugspunkt

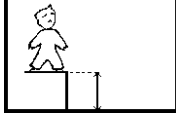
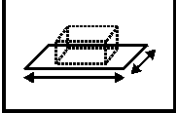
	
①	0.9m
②	<0.6m
	55m ²
	76m ²

INSTALLATION



0.6m³



2

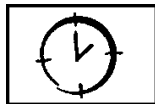

03H00

CERTIFICATIONS



V 1 - 2009-11-26