

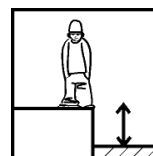

1=5.54m 2=3.7m 3=3.2m



**OTHER INFORMATION**



HCL= 2m

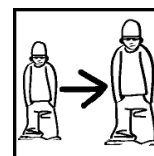

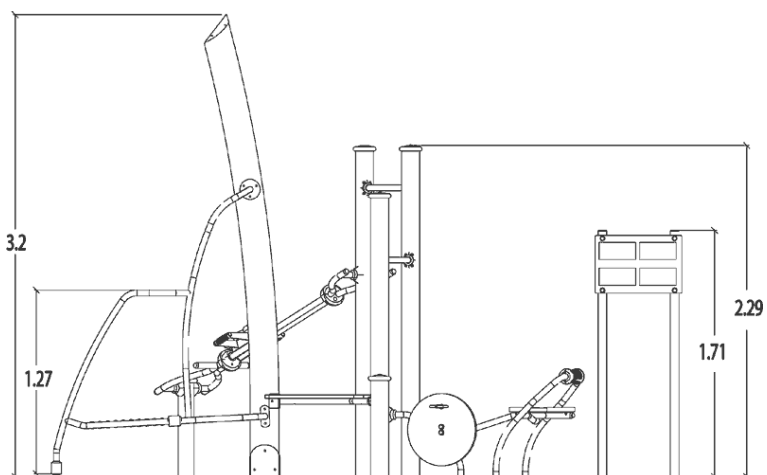

10+



**Installation of equipment**

Impact area = minimum safety surfacing required according to EN 1176-1/ EN 1177

-  Impact area
-  Free space

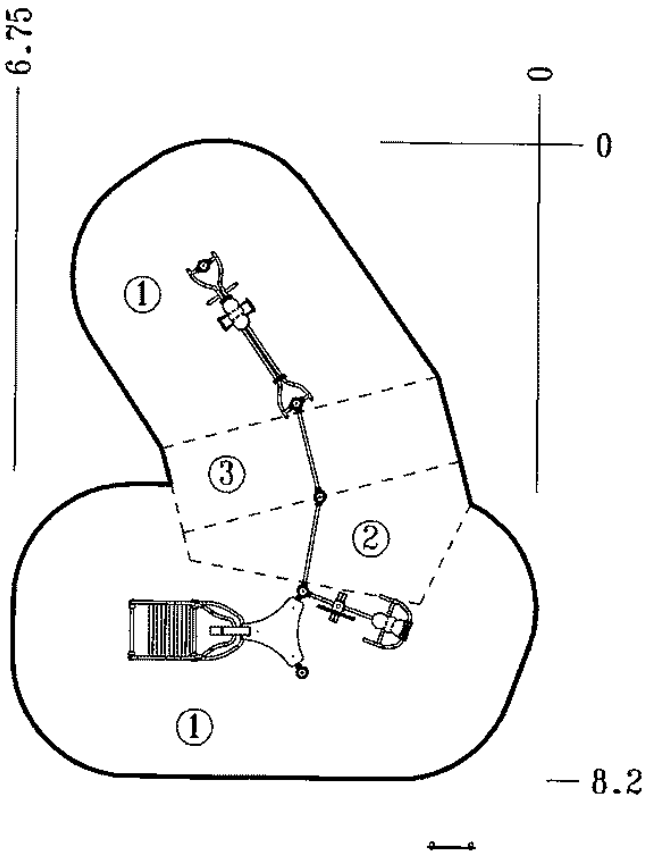

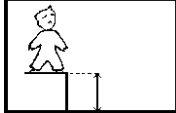
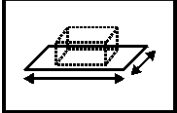
		
①	0m	31m <sup>2</sup>
②	1.5m	4m <sup>2</sup>
③	2m	4.5m <sup>2</sup>

**INSTALLATION**

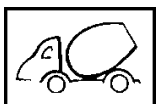

0.4m<sup>3</sup>



2

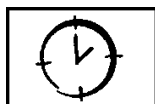

02H00

**CERTIFICATIONS**

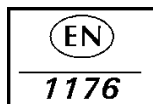

V 2 - 2006-06-13